



NIT No.: TPCODL/P&S/1000000304/22-23

## **Open Tender Notification**

**For**

**Rate contract for Supply of piercing connector  
& mid span jointing Kit for Covered conductor.**

**Tender Enquiry No.: TPCODL/P&S/1000000304/2022-23**

**Due Date for Bid Submission: 17 – November – 2022 [17:00 Hrs.]**

**TP Central Odisha Distribution Limited  
2<sup>nd</sup> Floor, IDCO Towers, Janpath, Bhubaneswar – 751022**



NIT No.: TPCODL/P&S/100000304/22-23

**CONTENTS OF THE ENQUIRY**

<b>S. NO.</b>	<b>PARTICULARS</b>
1.	Event Information
2.	Submission of Bid Documents
3.	Bid Opening & Evaluation process
4.	Evaluation Criteria
5.	Award Decision
6.	Order of Preference/Contradiction
7.	Post Award Contract Administration
8.	Specifications and Standards
9.	General Conditions of Contract
10.	Safety
<b>Annexures</b>	
I	Annexure I – Price Schedule of Items
II	Annexure II – Material Specification & Other conditions
III	Annexure III – Schedule of Deviations
IV	Annexure IV – Schedule of Commercial Specifications
V	Annexure V – Document Check List
VI	Annexure VI – Acceptance Form for Participation in Reverse Auction Event
VII	Annexure VII – General Condition of Contract
VIIA	Annexure VIIA – Preferential norms for procurement from MSMEs registered in the state of Odisha
VIII	Annexure VIII – Safety Policy and Safety Terms and Conditions
IX	Annexure IX - Environment & Sustainability Policy
X	Annexure X – Tata Code of Conduct(TCOC)

## 1.0 Event Information

### 1.1. Scope of work

**Open Tenders** are invited from interested Bidders entering into a Rate Contract valid for one year for the following:

Sl. No.	Description	EMD Amount (Rs.)	Tender Fee (Rs.)
1.	Rate contract for Supply of piercing connector & mid-span jointing Kit for Covered conductor.	50,000/-	5,000/-
	➤ Tender Fee is inclusive of GST		
	➤ EMD is exempted for MSMEs registered in the State of Odisha.		
	➤ MSMEs registered in the State of Odisha shall pay the tender fee of Rs. 1,000/- including GST.		
	➤ For details of MSME norms, please refer to "Annexure-VII (a)"		

### 1.2. Availability of Tender Documents

Please refer "Procedure to participate in the e-tender".

### 1.3. Calendar of Events

(a)	Date of sale/ availability of tender documents from TPCODL Website	From 02.11.2022 onwards
(b)	Date by which Interested and Eligible Bidder to pay Tender Fee and confirm participation as mentioned in "Procedure to Participate in Tender"	09.11.2022 up to 17:00 Hrs.
(c)	Date & Time of Pre-Bid Meeting (If any)	To be Announced
(d)	Last Date and time of receipt of pre-bid queries, if any	11.11.2022 up to 17:00 Hrs.
(e)	Last Date of Posting Consolidated replies to all the pre-bid queries as received	13.11.2022 up to 17:00 Hrs.
(f)	Last date and time of receipt of Bids	17.11.2022 up to 17:00 Hrs.

**Note:-** In the event of the last date specified for submission of bids and date of opening of bids is declared as a closed holiday for TPCODL, Bhubaneswar office the last date of submission of bids and date of opening of bids will be the following working day at appointed times

### 1.4 Mandatory documents required along with the Bid

- 1.4.1 EMD of requisite value and validity
- 1.4.2 Tender fee payment details
- 1.4.3 Requisite Documents for compliance to Qualification Criteria mentioned in Clause 1.7.
- 1.4.4 Annexure-II, Material Specification and other conditions. Duly signed and stamped by bidder.
- 1.4.5 Duly signed and stamped 'Schedule of Deviations' as per Annexure III on bidder's letterhead.
- 1.4.6 Duly signed and stamped 'Schedule of Commercial Specifications' as per Annexure-IV on bidder's letter head.
- 1.4.7 Duly filled in Annexure V and VI.
- 1.4.8 Proper authorization letter/ Power of Attorney to sign the tender on the behalf of bidder.



NIT No.: TPCODL/P&S/1000000304/22-23

1.4.9 Copy of PAN, GST, PF and ESI Registration (In case any of these documents is not available with the bidder, same to be explicitly mentioned in the 'Schedule of Deviations')

***Please note that in absence of any of the above documents, the bid submitted by a bidder shall be liable for rejection.***

### **1.5. Deviation from Tender**

Normally, the deviations to tender terms are not admissible and the bids with deviation are liable for rejection. Hence, the bidders are advised to refrain from taking any deviations on this Tender. Still in case of any deviations, all such deviations shall be set out by the Bidders, clause by clause in the 'Annexure III - Schedule of Deviations' and same shall be submitted as a part of the Technical Bid.

### **1.6. Right of Acceptance/Rejection**

Bids are liable for rejection in absence of following documents: -

- i. EMD of requisite value and validity
- ii. Tender fee of requisite value
- iii. Price Bid as per the Price Schedule mentioned in Annexure I (BOQ)
- iv. Necessary documents against compliance to Qualification Requirements mentioned at Clause 1.7 of this Tender Document
- v. Filled in Schedule of Deviations as per Annexure III
- vi. Filled in Schedule of Commercial Specifications as per Annexure IV
- vii. Receipt of Bid within the due date and time
- viii. Signed and stamped Annexure II, Annexure IV, Annexure V and Annexure VI

TPCODL reserves the right to accept/reject any or all the bids without assigning any reason thereof.

### **1.7 Qualification Criteria**

The bidder should meet the following criteria:

1. The bidder should have average annual financial turnover during the last three years i.e. FY 18-19, FY 20-21 & FY 21-22 not less than at least **Rs 1.0 Cr.** Audited balance sheet, profit, and loss account, and auditors report from the statutory auditors of the company required.
2. The bidder should have executed a single number of Purchase orders of a minimum of Rs. 20 Lac. Or three numbers of Purchase orders of minimum Rs. 10 Lac. Each in the last 05 years. Copy of work order/completion certificate to be submitted in this regard.
3. The bidder should have performance certificates for 5 years of satisfactory performance from at least 2 reputed companies for similar or higher voltage ratings of similar works. The work against these issued certificates should be completed in the last seven years from the date of bid submission. In case the bidder has a previous association with Tata Power DDL for similar products and services, the performance feedback for that bidder by TPNODL, TPSODL, TPWODL, Tata Power DDL's / TPC Mumbai User Group shall only be considered irrespective of performance certificates issued by any third organization.
4. The bidder should have its manufacturing facility manufacture of the similar items or higher voltage level. The bidder must submit an undertaking in this regard.
5. Bidder should have the In-house testing facilities for acceptance tests as per TPCODL specifications. The bidder must submit an undertaking in this regard.
6. The Bidder shall furnish the type test certificates of the tests as mentioned above as per the corresponding standards. All the tests shall be conducted at CPRI/ERDA or any government lab as per the relevant IS/IEC. Type tests should have been conducted in certified Test laboratories during the period not exceeding 5 years from the date of opening the bid. In the event of any discrepancy in the test reports, i.e. any test report



NIT No.: TPCODL/P&S/1000000304/22-23

not acceptable, same shall be carried out without any cost implication to TPCODL.

7. Bidder must have all statutory compliance like valid PAN, MSME cert., ESI registration, EPF registration, and GSTN registration.

However, TPCODL reserve the right to scrutinize and reject any of such existing vendors without assigning reason what so ever may be.

### **1.8. Marketing Integrity**

We have a fair and competitive marketplace. The rules for bidders are outlined in the General Condition of Contracts. Bidders must agree to these rules prior to participating. In addition to other remedies available, TPCODL reserves the right to exclude a bidder from participating in future markets due to the bidder's violation of any of the rules or obligations contained in the General Condition of Contracts. A bidder who violates the market place rules or engages in behavior that disrupts the fair execution of the marketplace, may result in restriction of a bidder from further participation in the marketplace for a length of time, depending upon the seriousness of the violation. Examples of violations include, but are not limited to:

- Failure to honor prices submitted to the marketplace
- Breach of terms as published in TENDER/NIT

### **1.9. Supplier Confidentiality**

All information contained in this tender is confidential and shall not be disclosed, published or advertised in any manner without written authorization from TPCODL. This includes all bidding information submitted to TPCODL. All tender documents remain the property of TPCODL and all suppliers are required to return these documents to TPCODL upon request. Suppliers who do not honor these confidentiality provisions will be excluded from participating in future bidding events.

### **2.0 Evaluation Criteria**

- The bids will be evaluated technically on the compliance to tender terms and conditions
- The bids will be evaluated commercially on the overall all-inclusive lowest cost for complete tender BoQ as calculated in Schedule of Items [Annexure I]. TPCODL however, reserves right to split the order line item wise and/or quantity wise among more than one Bidder. Hence all bidders are advised to quote their most competitive rates against each line item.
- In case, it is observed that the bidders have under quoted the prices against any line items w.r.t. applicable market rates of raw materials, labour charges etc. then TPCODL reserves the right to outrightly-reject such bids.
- Bidder has to mandatorily quote against each item of Schedule of Items [Annexure I]. Failing to do so, TPCODL may reject the bids.

**NOTE:** In case a new bidder is not registered with TPCODL, their job site factory inspection and evaluation shall be carried out to ascertain bidder's manufacturing capability and quality procedures. However, TPCODL reserves the right to carry out factory inspection and evaluation for any bidder prior to technical qualification.

In case a bidder is found as Disqualified in the above evaluation process, their bid shall not be evaluated any further and shall be summarily rejected. The decision of TPCODL shall be final and binding on the bidder in this regard.

### **3.0 Submission of Bid Documents**

#### **3.1 Bid Submission**

Bidders are requested to submit their offer in line with this Tender document. TPCODL shall



NIT No.: TPCODL/P&S/1000000304/22-23

respond to the clarification raised by various bidders and the replies will be sent to all participating bidders through TPCODL website/ e-tender portal/ e-mail.

Bids shall be submitted in 3 (three) parts:

**FIRST PART: "EMD"** as applicable shall be submitted. The EMD shall be valid for 210 days from the due date of bid submission in the form of BG / Bank Draft / Bankers Pay Order (issued from a Scheduled Bank) online NEFT/ RTGS transfer favoring "TP Central Odisha Distribution Limited" payable at Bhubaneswar. The EMD BG has to be strictly in the format as mentioned in General Condition of Contract, failing which it shall not be accepted by TPCODL and the bid as submitted shall be liable for rejection. A separate non-refundable tender fee of stipulated amount also needs to be transferred online through NEFT/ RTGS to TPCODL.

TPCODL Bank Details for transferring Tender Fee and EMD is as below:

**Account Name:** TP CENTRAL ODISHA DISTRIBUTION LIMITED

**Bank Name:** SBI, IDCO Towers, Bhubaneswar

**Bank Account No.:** 10835304915

**IFSC Code:** SBIN0007891

For Tender Fee and EMD submitted via online transfer, bidder to ensure that the same are carried out through separate transactions.

The EMD in the form of Bank Draft / BG / Bankers Pay Order shall be delivered at the following address in sealed envelope clearly indicating the tender reference / enquiry number, name of tender and bidder name:

Chief (Procurement & Stores)

TP Central Odisha Distribution Limited

2<sup>nd</sup> Floor, IDCO Towers, Janpath, Bhubaneswar-751022

**SECOND PART: "TECHNICAL BID"** shall contain the following documents:

- a) Documentary evidence in support of qualifying criteria as per clause no 1.7 above.
- b) Annexure II duly signed and stamped by bidder.
- c) No Deviation Certificate as per the Annexure III – Schedule of Deviations, duly signed and stamped.
- d) Annexure II, Specification and other conditions, stamped and signed.
- e) Annexure IV duly filled, stamped and signed.
- f) Annexure V and VI, duly stamped and signed.
- g) Photos or catalogue of the furniture, stamped and signed.

**The technical bid shall be properly indexed and is to be submitted through TPCODL E-tender platform (Ariba) only. Hard copy of Technical Bids need not be submitted.**

The Bid prepared by the Bidder, and all correspondence and documents relating to the Bid exchanged by the Bidder and the TPCODL, shall be written in the English Language. Any printed literature furnished by the Bidder may be written in another Language, provided that this literature is accompanied by an English translation, in which case, for purposes of interpretation of the Bid, the English translation shall govern.

**THIRD PART: "PRICE BID"** shall contain only the price details and strictly in format as mentioned in Annexure I along with explicit break up of basic prices, Taxes & duties, Freight etc. In case any discrepancy is observed between the item description stated in Schedule of Items mentioned in the tender and the price bid submitted by the bidder, the item description as mentioned in the tender document (to the extent modified through Corrigendum issued if any) shall prevail. Price Bid is to be submitted in soft copy through TPCODL E-Tendering system (Ariba) only. Hard copy



NIT No.: TPCODL/P&S/1000000304/22-23

of Price Bid not be submitted.

**Price bid are to be submitted both in PDF format duly signed & stamp and in Excel Spreadsheet through ARIBA online e-procurement platform.**

**SIGNING OF BID DOCUMENTS:**

The bid must contain the name, residence and place of business of the person or persons making the bid and must be signed and sealed by the Bidder with his usual signature. The names of all persons signing should also be typed or printed below the signature.

The Bid being submitted must be signed by a person holding a Power of Attorney authorizing him to do so, certified copies of which shall be enclosed. The Bid submitted on behalf of companies registered with the Indian Companies Act, for the time being in force, shall be signed by persons duly authorized to submit the Bid on behalf of the Company and shall be accompanied by certified true copies of the resolutions, extracts of Articles of Association, special or general Power of Attorney etc. to show clearly the title, authority and designation of persons signing the Bid on behalf of the Company. Satisfactory evidence of authority of the person signing on behalf of the Bidder shall be furnished with bid.

A bid by a person who affixes to his signature the word 'President', 'Managing Director', 'Secretary', 'Agent' or other designation without disclosing his principal will be rejected. The Bidder's name stated on the Proposal shall be the exact legal name of the firm.

**3.2 Contact Information**

All the bidders are requested to send their pre-bid queries (if any) against this tender through e-mail within the stipulated timelines. The consolidated reply to all the queries received shall be posted on TPCODL website by the stipulated timelines as detailed in calendar of events.

**Communication Details:**

**Package Owner**

Name: Sujit Patra  
Designation: Lead Engg - Procurement  
Contact No.: 7008941254  
E-Mail ID: [Sujit.patra@tpcentralodisha.com](mailto:Sujit.patra@tpcentralodisha.com)

Bidders are strictly advised to communicate with Package Owner through TPCODL E-tender System (Ariba) only. They need to pay Tender Participation Fee to receive the Ariba log-in. The above escalation details are for reference purpose only.

**3.3 Bid Prices**

Bidders shall quote for the entire Scope of Supply/ work with a break up of prices for individual items and Taxes & duties. The bidder shall complete the appropriate Price Schedules included herein, stating the Unit Price for each item & total price with taxes, duties & freight up to destination at various sites of TPCODL. The all-inclusive prices offered shall be inclusive of all costs as well as Duties, Taxes and Levies paid or payable during the execution of the supply work, breakup of price constituents.

**Applicable GST to be specified clearly.**

The quantity break up shown elsewhere other than Price Schedule is tentative. The bidder shall ascertain himself regarding material required for completeness of the entire work. Any items not indicated in the price schedule but which are required to complete the job as per the Technical Specifications/ Scope of Work/ SLA mentioned in the tender, shall be deemed to be included in prices quoted.

### 3.4 Bid Currencies

Prices shall be quoted in Indian Rupees Only.

### 3.5 Period of Validity of Bids

Bids shall remain valid for 180 days from the due date of submission of the bid. Notwithstanding clause above, the TPCODL may solicit the Bidder's consent to an extension of the Period of Bid Validity. The request and responses thereto shall be made in writing.

### 3.6 Alternative Bids

Bidders shall submit Bids, which comply with the Bidding documents. Alternative bids will not be considered. The attention of Bidders is drawn to the provisions regarding the rejection of Bids in the terms and conditions, which are not substantially responsive to the requirements of the bidding documents.

### 3.7 Modifications and Withdrawal of Bids

The bidder is not allowed to modify or withdraw its bid after the Bid's submission. The EMD as submitted along with the bid shall be liable for forfeiture in such event.

### 3.8 Earnest Money Deposit (EMD)

The bidder shall furnish, as part of its bid, an EMD amounting as specified in the tender. The EMD is required to protect TPCODL against the risk of bidder's conduct which would warrant forfeiture. The EMD shall be denominated in any of the following form:

- Banker's Cheque/ Demand Draft/ Pay order drawn in favor of TP Central Odisha Distribution Limited payable at Bhubaneswar.
- Online transfer of requisite amount through NEFT/ RTGS.
- Bank Guarantee valid for 210 days after due date of submission.

#### *The EMD shall be forfeited in case:*

- a) The bidder withdraws its bid during the period of specified bid validity.

**Or**

- b) The successful Bidder does not
  - a) accept the Purchase Order, or
  - b) furnish the required Performance Security Bank Guarantee

## 4 Bid Opening & Evaluation process

### 4.1. Process to be confidential

Information relating to the examination, clarification, evaluation and comparison of Bids and recommendations for the award of a contract shall not be disclosed to Bidders or any other persons not officially concerned with such process. Any effort by a Bidder to influence the TPCODL's processing of Bids or award decisions may result in rejection of the Bidder's Bid.

### 4.2. Technical Bid Opening

Bids will be opened at TPCODL Office, Bhubaneswar. All tender bids shall be opened internally by TPCODL. Presence of any bidder will not be allowed during bid opening process. Technical bid must not contain any cost information whatsoever. First the envelope marked "EMD" will be opened. Bids without EMD/cost of tender (if applicable) of required amount/ validity in prescribed format, shall be rejected. Next, the technical bid of the bidders who have furnished the requisite EMD will be opened, one by one.





NIT No.: TPCODL/P&S/1000000304/22-23

#### **4.3. Preliminary Examination of Bids/Responsiveness**

TPCODL will examine the Bids to determine whether they are complete, whether any computational errors have been made, whether required sureties have been furnished, whether the documents have been properly signed, and whether the Bids are generally in order. TPCODL may ask for submission of original documents in order to verify the documents submitted in support of qualification criteria. Arithmetical errors will be rectified on the following basis: If there is a discrepancy between the unit price and the total price per item that is obtained by multiplying the unit price and quantity, the unit price shall prevail and the total price per item will be corrected. If there is a discrepancy between the Total Amount and the sum of the total price per item, the sum of the total price per item shall prevail and the Total Amount will be corrected. Prior to the detailed evaluation, TPCODL will determine the substantial responsiveness of each Bid to the Bidding Documents including production capability and acceptable quality of the Goods offered. A substantially responsive Bid is one, which conforms to all the terms and conditions of the Bidding Documents without material deviation. Bid determined as not substantially responsive will be rejected by the TPCODL and may not subsequently be made responsive by the Bidder by correction of the non-conformity.

#### **4.4. Techno Commercial Clarifications**

Bidders need to ensure that the bids submitted by them are complete in all respects. To assist in the examination, evaluation and comparison of Bids, TPCODL may, at its discretion, ask the Bidder for a clarification on its Bid for any deviations with respect to the TPCODL specifications and attempt will be made to bring all bids on a common footing. All responses to requests for clarification shall be in writing and no change in the price or substance of the Bid shall be sought, offered or permitted owing to any clarifications sought by TPCODL.

#### **4.5. Price Bid Opening**

Price bids will be opened internally without the presence of any bidder representative. The EMD of the bidder withdrawing or substantially altering his offer at any stage after the technical bid opening will be forfeited at the sole discretion of TPCODL without any further correspondence in this regard.

#### **4.6. Reverse Auctions**

TPCODL reserves the right to conduct the reverse auction (instead of public opening of price bids) for the products/ services being asked for in the tender. The terms and conditions for such reverse auction events shall be as per the Acceptance Form attached as Annexure VI of this document. The bidders along with the tender document shall mandatorily submit a duly signed copy of the Acceptance Form attached as Annexure VI as a token of acceptance for the same.

#### **5 Award Decision**

TPCODL will award the contract to the successful bidder whose bid has been determined to be the lowest-evaluated responsive bid as per the Evaluation Criterion mentioned at Clause 2.0. The Cost for the said calculation shall be taken as the all-inclusive cost quoted by bidder in Annexure I (Schedule of Items) subject to any corrections required in line with Clause 4.3 above. The decision to place purchase order/LOI solely depends on TPCODL on the cost competitiveness across multiple lots, quality, delivery and bidder's capacity, in addition to other factors that TPCODL may deem relevant. TPCODL reserves the rights to award contract to one or more bidders so as to meet the delivery requirement or nullify award decision without assigning any reason thereof. In case any supplier is found unsatisfactory during delivery process, the award will be cancelled and TPCODL reserves right to award contract to other suppliers who are found fit.



NIT No.: TPCODL/P&S/1000000304/22-23

## **6 Order of Preference/Contradiction**

In case of contradiction in any part of various documents in tender, following shall prevail in order of preference:

1. Schedule of Items (Annexure I)
2. Post Award Contract Administration (Clause 7.0)
3. Submission of Bid Documents (Clause 3.0)
4. Specification and other conditions (Annexure II)
5. Acceptance Form for Participation in Reverse Auction (Annexure VI)
6. General Conditions of Contract (Annexure VII)

## **7 Post Award Contract Administration**

### **7.1. Special Conditions of Contract**

- Bids are to be submitted all items Annexure I.
- Any change in statutory taxes, duties and levies during the contract period shall be borne by TPCODL. All the terms and conditions of TPCODL General Conditions of Contract for Service Orders shall be applicable.

### **7.2 Drawing Submission and Approval**

Not Applicable, if required.

### **7.3 Period of Contract**

One year from the release of the order.

### **7.4 Payment Terms**

100% payment of final bill shall be released within 30 days from the date of submission of certified bills/ invoices with complete details and fulfilment of statutory compliances and other requirements, if any.

### **7.5 Climate Change**

Significant quantities of waste are generated during the execution of job and an integrated approach for effective handling, storage, transportation and disposal of the same shall be adopted. This would ensure the minimization of environmental and social impact in order to combat the climate change. Please refer attached Environment Policy and Sustainability Policy, Annexure-X for more details.

### **7.6 Ethics**

TPCODL is an ethical organization and as a policy TPCODL lays emphasis on ethical practices across its entire domain. Bidder should ensure that they should abide by all the ethical norms and in no form either directly or indirectly be involved in unethical practice. TPCODL work practices are governed by the Tata Code of Conduct which emphasizes on the following:

- We shall select our suppliers and service providers fairly and transparently.
- We seek to work with suppliers and service providers who can demonstrate that they share similar values. We expect them to adopt ethical standards comparable to our own.
- Our suppliers and service providers shall represent our company only with duly authorized written permission from our company. They are expected to abide by the Code in their interactions with, and on behalf of us, including respecting the confidentiality of information shared with them. We shall ensure that any gifts or hospitality received from, or given to, our suppliers or service providers comply with our company's gifts and hospitality policy.
- We respect our obligations on the use of third party intellectual property and data.



**NIT No.: TPCODL/P&S/1000000304/22-23**

Bidder is advised to refer Tata Code of Conduct (TCOC) attached at Annexure IX for more information. Any ethical concerns with respect to this tender can be reported to the following e-mail ID: pravin.jain@tpcentralodisha.com

**8 Specification and standards**

As per Annexure I and II.

**9 General Condition of Contract**

Any condition not mentioned above shall be applicable as per GCC attached along with this tender, Annexure VII.

**10 Safety**

All jobs are this tender have to be executed strictly in compliance to the Safety terms and Conditions of TP Central Odisha Distribution Limited. Please refer attached Safety terms and conditions, Annexure- VIII, for details. Violation of Safety norms will result in Penalty as mentioned in the above document.



NIT No.: TPCODL/P&S/100000304/22-23

**ANNEXURE I**  
**Price Schedule**

Sl	Item	Unit	Qty.	Unit Rate	GST	Amount with GST	Total Rate Rs.
1	IPC FOR 33KV 99 SQ. MM CVRD. AAAC	110	EA				
2	IPC FOR 33KV 241SQ. MM CVRD. AAAC	240	EA				
3	IPC FOR 11KV 50 SQ. MM CVRD. AAAC	50	EA				
4	IPC FOR 11KV 70 SQ. MM CVRD. AAAC	100	EA				
5	IPC FOR 11KV 99 SQ. MM CVRD. AAAC	1116	EA				
6	MIDSPAN JOINT FOR 33KV 99SQ MM CVRD AAAC	15	EA				
7	MIDSPAN JOINT FOR 33KV 241SQ MM CVRD AAC	75	EA				
8	MIDSPAN JOINT FOR 11KV 50SQ MM CVRD AAAC	20	EA				
9	MIDSPAN JOINT FOR 11KV 70SQ MM CVRD AAAC	56	EA				
10	MIDSPAN JOINT 33KV-CVRD CNDCTR-148SQMM	30	EA				
11	33KV IPC FOR CVRD CONDUCTOR-148 SQMM	120	EA				
12	NON METALIC TIES FOR 11KV CVRD AAAC/ACSR	927	EA				
13	NON METALLIC TIES 33KV-CVRD CONDUCTR-148MM	2465	EA				
	Total						

**NOTE:**

- Bidders are advised to quote prices strictly in the format attached.
- The bidder must fill each and every column of the format attached. ***Mentioning "extra/inclusive" in any of the column may lead for rejection of the price bid.***
- No cutting/ overwriting in the prices is permissible.
- The bids will be evaluated commercially on the overall lowest cost in line item basis.
- The prices shall be on Delivered basis at any TPCODL location with application, fixing and erection charges. Details of locations given below.
- The bidders shall quote against each of the line items as indicated above. The quantity as mentioned above neither implies nor guarantees any minimum deployment thereunder. The above quantity is indicative only based on TPCODL estimates and it is not binding on us for fulfillment. Actual quantities may vary as per TPCODL's requirements.
- Delivery Location: - Across TPCODL.



NIT No.: TPCODL/P&S/100000304/22-23

**ANNEXURE III**

**Schedule of Deviations**

*Bidders are advised to refrain from taking any deviations on this TENDER. Still in case of any deviations, all such deviations from this tender document shall be set out by the Bidders, Clause by Clause in this schedule and submit the same as a part of the **Technical Bid**.*

*Unless **specifically** mentioned in this schedule, the tender shall be deemed to confirm the TPCODL's specifications:*

<b>S. No.</b>	<b>Clause No.</b>	<b>Tender Clause Details</b>	<b>Details of deviation with justifications</b>

*By signing this document, we hereby withdraw all the deviations whatsoever taken anywhere in this bid document and comply to all the terms and conditions, technical specifications, scope of work etc.as mentioned in the standard document except those as mentioned above.*

*Seal of the*

*Bidder:*

*Signature:*

*Name:*



NIT No.: TPCODL/P&S/1000000310/22-23

**ANNEXURE IV**  
**Schedule of Commercial Specifications**

*(The bidders shall mandatorily fill in this schedule and enclose it with the offer Part I: Technical Bid. In the absence of all these details, the offer may not be acceptable.)*

S. No.	Particulars	Remarks
1.	Prices firm or subject to variation (If variable indicate the price variation clause with the ceiling if applicable)	Firm / Variable
1a.	If variable price variation on clause given	Yes / No
1b.	Ceiling	-----%
1c.	Inclusive of GST	Yes / No (If Yes, indicate % rate)
1d.	Inclusive of transit insurance	Yes / No
2.	Delivery	Weeks / months
3.	Guarantee clause acceptable	Yes / No
4.	Terms of payment acceptable	Yes / No
5.	Performance Bank Guarantee acceptable	Yes / No
6.	Liquidated damages clause acceptable	Yes / No
7.	Validity (180 days) No (From the date of opening of bid)	Yes /
8.	Inspection during stage of manufacture	Yes / No
9.	Rebate for increased quantity	Yes / No (If Yes, indicate value)
10.	Change in price for reduced quantity	Yes / No (If Yes, indicate value)
11.	Covered under Small Scale and Ancillary Industrial Undertaking Act 1992	Yes / No (If Yes, indicate, SSI Reg'n No.)

***Seal of the***

***Bidder:***

***Signature:***

***Name:***



NIT No.: TPCODL/P&S/100000310/22-23

**ANNEXURE V**

**Checklist of all the documents to be submitted with the Bid**

Bidder has to mandatorily fill in the checklist mentioned below: -

<b>S. No.</b>	<b>Documents attached</b>	<b>Yes / No / Not Applicable</b>
1	EMD of required value	
2	Tender Fee as mentioned in this tender	
3	Signed copy of this tender as an unconditional acceptance	
5	Duly filled schedule of commercial specifications (Annexure IV)	
6	Sheet of commercial/technical deviation if any (Annexure III)	
7	Balance sheet for the last completed three financial years; mandatorily enclosing Profit & loss account statement	
8	Acknowledgement for Testing facilities if available (duly mentioned on bidder letter head)	
9	List of Machine/tools with updated calibration certificates if applicable	
10	Details of order copy (duly mentioned on bidder letter head)	
11	Order copies as a proof of quantity executed	
12	Details of Type Tests if applicable (duly mentioned on bidder letter head)	
13	All the relevant Type test certificates as per relevant IS/IEC (CPRI/ERDA/other certified agency) if applicable	
14	Project/supply Completion certificates	
15	Performance certificates	
16	Client Testimonial/Performance Certificates	
17	Credit rating/solvency certificate	
18	Undertaking regarding non blacklisting (On company letter head)	
19	List of trained/untrained Manpower	

***Seal of the Bidder:***

***Signature:***

***Name***



NIT No.: TPCODL/P&S/1000000310/22-23

**ANNEXURE VI**

**ACCEPTANCE FORM FOR PARTICIPATION IN REVERSE AUCTION EVENT**

*(To be signed and stamped by the bidder)*

In a bid to make our entire procurement process more fair and transparent, TPCODL intends to use the reverse auctions as an integral part of the entire tendering process. All the bidders who are found as technically qualified based on the tender requirements shall be eligible to participate in the reverse auction event.

**The following terms and conditions are deemed as accepted by the bidder on participation in the bid event:**

1. TPCODL shall provide the user id and password to the authorized representative of the bidder. *(Authorization Letter in lieu of the same shall be submitted along with the signed and stamped Acceptance Form).*
2. TPCODL will make every effort to make the bid process transparent. However, the award decision by TPCODL would be final and binding on the supplier.
3. The bidder agrees to non-disclosure of trade information regarding the purchase, identity of TPCODL, bid process, bid technology, bid documentation and bid details.
4. The bidder is advised to understand the auto bid process to safeguard themselves against any possibility of non-participation in the auction event.
5. In case of bidding through Internet medium, bidders are further advised to ensure availability of the entire infrastructure as required at their end to participate in the auction event. Inability to bid due to telephone line glitch, internet response issues, software or hardware hangs, power failure or any other reason shall not be the responsibility of TPCODL.
6. In case of intranet medium, TPCODL shall provide the infrastructure to bidders. Further, TPCODL has sole discretion to extend or restart the auction event in case of any glitches in infrastructure observed which has restricted the bidders to submit the bids to ensure fair & transparent competitive bidding. In case of an auction event is restarted, the best bid as already available in the system shall become the start price for the new auction.
7. In case the bidder fails to participate in the auction event due any reason whatsoever, it shall be presumed that the bidder has no further discounts to offer and the initial bid as submitted by the bidder as a part of the tender shall be considered as the bidder's final no regret offer. Any offline price bids received from a bidder in lieu of non-participation in the auction event shall be out-rightly rejected by TPCODL.
8. The bidder shall be prepared with competitive price quotes on the day of the bidding event.
9. The prices as quoted by the bidder during the auction event shall be inclusive of all the applicable taxes, duties and levies and shall be FOR at TPCODL site.
10. The prices submitted by a bidder during the auction event shall be binding on the bidder.
11. No requests for time extension of auction event shall be considered by TPCODL.
12. The original price bids of the bidders shall be reduced on pro-rata basis against each line item based on the final all-inclusive prices offered during conclusion of the auction event for arriving at Contract amount.

**Signature & Seal of the Bidder**





NIT No.: TPCODL/P&S/1000000310/22-23

**ANNEXURE VII**  
**GENERAL CONDITIONS OF CONTRACT**

**Attached:** General Conditions of Contract for Service Orders



NIT No.: TPCODL/P&S/1000000310/22-23

**Annexure VIIA – Preferential norms for procurement from MSMEs registered in the state of Odisha**

**1) Tender Fees**

To participate in the tender, MSMEs registered in the State of Odisha shall pay Rs.1,000/- including GST towards cost of tender paper.

**2) Earnest Money Deposit (EMD)**

EMD shall be exempted for MSME registered in the State of Odisha. However, Bidder shall be barred to participate in the tendering process for a period of 2 years in case it backs out post award of the contract.

**3) Qualification Requirement for Open Tenders**

Qualification Requirement of Financial Turnover for MSME registered in the State of Odisha shall be reduced to 20% of the existing criteria.

For past experience, instead of relying on the volumes / value of earlier Supplies / Projects, assessment of the Bidder shall be done on the basis of feedback from Customers. Past performance experience at Tata Power and its Group Companies shall supersede feedback from other Customers.

**4) Reservation for MSME**

It shall be mandatory to procure at least 20% of the total volume of the procurement from MSME registered in the State of Odisha (however, it shall not apply where goods/services are not available with the MSME), subject to matching L1 discovered prices and meeting technical specifications including quality requirements.

**5) Performance Bank Guarantees**

Performance Bank Guarantee for MSME registered in the State of Odisha shall be 25% of the value normally prescribed.

 <b>TPCODL</b> <small>TP CENTRAL ODISHA DISTRIBUTION LIMITED</small>	<b>TP CENTRAL ODISHA DISTRIBUTION LIMITED, BHUBANESWAR</b>		
	<b>TECHNICAL SPECIFICATION</b>		
<b>Document Title</b>	<b>SPECIFICATION FOR ACCESSORIES OF 33kV XLPE COVERED CONDUCTOR</b>		
<b>Document No.</b>	ENG-ELC-072	<b>Issue Date: 13.05.2022</b>	
<b>Revision No.</b>	00	<b>Page 1 of 18</b>	
<b>Prepared by:</b> Barsha Bandita	<b>Reviewed By:</b> Jeevan Sangram	<b>Approved By:</b> Khajan C. Bhardwaj	<b>Issued By:</b> Pourush Garg

## **CONTENTS**

1. SCOPE
2. APPLICABLE STANDARDS
3. CLIMATIC CONDITIONS OF THE INSTALLATION
4. GENERAL TECHNICAL REQUIREMENTS
5. GENERAL CONSTRUCTIONS
6. MARKING
7. TESTS
8. TYPE TEST CERTIFICATES
9. PRE-DISPATCH INSPECTION
10. INSPECTION AFTER RECEIPT AT STORES
11. GUARANTEE
12. PACKING
13. TENDER SAMPLE
14. QUALITY CONTROL
15. TESTING FACILITIES
16. MANUFACTURING ACTIVITIES
17. SPARES, ACCESSORIES AND TOOLS
18. DRAWINGS AND DOCUMENTS
19. SCHEDULE "A" GUARANTEED TECHNICAL PARTICULARS
20. SCHEDULE "B" DEVIATIONS

 TP CODL TP CENTRAL ODISHA DISTRIBUTION LIMITED	TP CENTRAL ODISHA DISTRIBUTION LIMITED, BHUBANESWAR		
	TECHNICAL SPECIFICATION		
Document Title	SPECIFICATION FOR ACCESSORIES OF 33kV XLPE COVERED CONDUCTOR		
Document No.	ENG-ELC-072	Issue Date: 13.05.2022	
Revision No.	00	Page 2 of 18	
Prepared by: Barsha Bandita	Reviewed By: Jeevan Sangram	Approved By: Khajan C. Bhardwaj	Issued By: Pourush Garg

## 1. SCOPE

This specification covers the technical requirements of design, manufacture, testing at manufacturer's works, packing, forwarding, supply and unloading at site/store of Accessories for All Aluminum Alloy Stranded XLPE Covered Conductors for use on 33kV Distribution System.

## 2. APPLICABLE STANDARDS

The equipment covered by this specification shall unless otherwise stated, be designed, manufactured and tested in accordance with the latest editions of the following Indian, International Standards and shall conform to the regulations of the local authorities:

Ref. IS	Description
EN 50397-1:2006	Covered Conductor Specification- Up to 33 kV
EN 50397-2:2006	Covered Conductor Accessories Specification- up to 33 kV
EN 50397-2 (MARCH 2010)	Covered conductors for overhead lines and the related accessories for rated voltages above 1kV a.c. and not exceeding 36kV a.c. PART 2: Accessories for covered conductors : tests and acceptance criteria
IS 398:1996 (Part IV)	Specification for aluminum conductors for overhead distribution purpose
EN 61238-1: 2003	Compression and mechanical connectors for power cables for rated voltages up to 36 kV Test methods and requirements
ANSI C119.4 :2011	Electric Connectors - Connectors For Use Between Aluminum-To-Aluminum And Aluminum-To-Copper Conductors Designed For Normal Operation At Or Below 93 °C And Copper-To-Copper Conductors Designed For Normal Operation At Or Below 100 °C

 TP CODL TP CENTRAL ODISHA DISTRIBUTION LIMITED	TP CENTRAL ODISHA DISTRIBUTION LIMITED, BHUBANESWAR		
	<b>TECHNICAL SPECIFICATION</b>		
<b>Document Title</b>	<b>SPECIFICATION FOR ACCESSORIES OF 33kV XLPE COVERED CONDUCTOR</b>		
<b>Document No.</b>	ENG-ELC-072	<b>Issue Date: 13.05.2022</b>	
<b>Revision No.</b>	00	<b>Page 3 of 18</b>	
<b>Prepared by:</b> Barsha Bandita	<b>Reviewed By:</b> Jeevan Sangram	<b>Approved By:</b> Khajan C. Bhardwaj	<b>Issued By:</b> Pourush Garg

### 3. CLIMATIC CONDITIONS OF THE INSTALLATION:

1	Maximum ambient temperature	50 deg C
2	Max. Daily average ambient temp	35 deg C
3	Min Ambient Temperature	0 deg C
4	Maximum Humidity	95%
5	Average Annual Rainfall	150cm
6	Average No. of rainy days per annum	120
7	Altitude above MSL not exceeding	1000m
8	Wind Pressure	300 Km/hr
9	Earthquakes of an intensity in horizontal direction	equivalent to seismic acceleration of 0.3g
10	Earthquakes of an intensity in vertical direction	equivalent to seismic acceleration of 0.15g (g being acceleration due to gravity)

TPCODL service area has heavy saline conditions along the coast and High cyclonic Intensity winds with speed upto 300 Kmph. The atmosphere is generally laden with mild acid and dust in suspension during the dry months and is subjected to fog in cold months.

### 4. GENERAL TECHNICAL REQUIREMENTS:

The Accessories of 33kV XLPE Covered Conductor are specified below and shall consist of the following:

#### 4.1 TENSION ASSEMBLY-WEDGE TYPE (TA)

Sl. No.	Technical Parameters	Desired Values
1	Name of the manufacturer	To be furnished by bidder
2	Applicable Standard	EN 50397-2
3	Range of Conductor size	50 Sq.mm to 240 Sq.mm
4	Installation(with/without disassembly)	Ready-to-use (without disassembly)
5	Type & grade	Heat treated aluminium Alloy for Body and Weather resistant Thermoplastic for wedge
6	Application	33 kV

 TP CODL TP CENTRAL ODISHA DISTRIBUTION LIMITED	TP CENTRAL ODISHA DISTRIBUTION LIMITED, BHUBANESWAR		
	TECHNICAL SPECIFICATION		
Document Title	<b>SPECIFICATION FOR ACCESSORIES OF 33kV XLPE COVERED CONDUCTOR</b>		
Document No.	ENG-ELC-072	Issue Date: 13.05.2022	
Revision No.	00	Page 4 of 18	
Prepared by: Barsha Bandita	Reviewed By: Jeevan Sangram	Approved By: Khajan C. Bhardwaj	Issued By: Pourush Garg

Sl. No.	Technical Parameters	Desired Values
7	Mechanical Strength	To be furnished by the Bidder for each type of conductor
7	Dimensions (mm)	To be furnished by bidder

#### 4.2 NON METALLIC ALIGNMENT TIES

Sl. No.	Technical Parameters	Desired Values
1	Name of the manufacturer	To be furnished by bidder
2	Applicable Standard	EN 50397-2
3	Range of Conductor size	50 Sq.mm to 240 Sq.mm
4	Mounting	Can mount directly on cable without any accessories
5	Type	Top Tie
6	Material	UV Resistant Thermoplastic
7	Application	33 kV
8	Dimensions (mm)	To be furnished by bidder

#### 4.3 MECHANICAL CONNECTOR WITH HEAT SHRINK SLEEVE

Sl. No.	Technical Parameters	Desired Values
1	Name of the manufacturer	To be furnished by bidder
2	Applicable Standard	IEC 61238-1
3	Range of Conductor size	For Phase conductor of diameter range 50-240 sq.mm
4	Installation	Crimping by shear head bolt compression
5	Type of connection required	Connection by compression pressure
6	Is any metallic part carrying potential in operation exposed during installation	No
7	Material	Aluminium Alloy For mechanical connector UV resistant polymer for heat shrink sleeve
8	Connector ID	Ø 14 mm to Ø 33 mm

#### 4.4 INSULATION PIERCING CONNECTOR

Sl. No.	Technical Parameters	Desired Values
1	Name of the manufacturer	To be furnished by bidder

 TP CODL TP CENTRAL ODISHA DISTRIBUTION LIMITED	TP CENTRAL ODISHA DISTRIBUTION LIMITED, BHUBANESWAR		
	TECHNICAL SPECIFICATION		
Document Title	<b>SPECIFICATION FOR ACCESSORIES OF 33kV XLPE COVERED CONDUCTOR</b>		
Document No.	ENG-ELC-072	Issue Date: 13.05.2022	
Revision No.	00	Page 5 of 18	
Prepared by: Barsha Bandita	Reviewed By: Jeevan Sangram	Approved By: Khajan C. Bhardwaj	Issued By: Pourush Garg

Sl. No.	Technical Parameters	Desired Values
2	Applicable Standard	EN 50397-2
3	Range of Conductor sizes accommodated for Main & Branch	Main : 50 - 240 sq.mm Tap : 50 - 240 sq.mm
4	Application	33 kV
5	Type of connection required	Insulation Piercing Type (Covered to Covered)
6	Is any metallic part carrying potential in operation exposed during installation	No
7	Are end caps of branch cable a) Slide on type (b) Rigid	Slide on type
8	Are torque limiting shear heads provided to tightening bolts	Yes
9	Specified Torque	18±1.5 Nm
10	Torque for establishing connection between main and Tap (Nm)	Within 70% of Min. Torque specified

#### 4.5 MID SPAN JOINTS

Sl. No.	Technical Parameters	Desired Values
1	Name of the manufacturer	To be furnished by bidder
2	Applicable Standard	EN 50483-4
3	Type No & Size Range	For Phase conductor of 50 Sq.mm to 240 sq. mm
4	Application	33 kV
5	Type of connection required	Crimping type
6	Is any metallic part carrying potential in operation exposed during installation	No
7	Installation	Crimping by Hexagonal Compression

#### 5. GENERAL CONSTRUCTIONS:

##### 5.1 TENSION ASSEMBLY-WEDGE TYPE (TA)

For fitting onto a pole for tensioning at the beginning or end of a length of Covered Conductor, or for anchoring while a major change in direction. The Tension assembly consists of one wedge type Tension anchoring clamp and one Tracking protection IPC.

 TP CODL TP CENTRAL ODISHA DISTRIBUTION LIMITED	TP CENTRAL ODISHA DISTRIBUTION LIMITED, BHUBANESWAR		
	TECHNICAL SPECIFICATION		
Document Title	<b>SPECIFICATION FOR ACCESSORIES OF 33kV XLPE COVERED CONDUCTOR</b>		
Document No.	ENG-ELC-072	Issue Date: 13.05.2022	
Revision No.	00	Page 6 of 18	
Prepared by: Barsha Bandita	Reviewed By: Jeevan Sangram	Approved By: Khajan C. Bhardwaj	Issued By: Pourush Garg

The following key criterion to be followed for the design of the same:-

- a) There shall be no losable part (except Tracking IPC) in the process of clamping arrangement.
- b) The clamp should consist of an Aluminum alloy corrosion resistant casted body and self-adjusting fully insulating type of mechanical and weather resisting thermoplastic wedges which shall anchor/hold the conductor.
- c) Locking mechanism should be wedge type self-locking. Wedges are to be made of high strength, climatic resistance Engineering Plastic with glass fiber.
- d) The fittings shall be able to withstand the specific minimum failure load (SMFL) and shall not damage the covering of cable. SMFL is the minimum failure load for clamp at which mechanical failure will not take place.
- e) No tools shall be needed for fitting the Covered Conductor into the clamp.
- f) The Anchoring clamp shall have an IPC to avoid tracking phenomenon by maintaining the metallic clamp as well as the cable passing through it at equipotential.

## 5.2 NON METALLIC ALIGNMENT TIES:

For supporting and aligning Covered Conductor at an intermediate pole in a length, with small angle of deviation. The Tie hold the Covered Conductor in its position on top of the pin insulator. Tie consists of an “Insulated Plastic” Type for Lin Alignment. The ties shall be designed suitably to hold the Covered Conductor in its position on top of the insulator. The Tie shall be made of Insulating Plastic materials (UV Resistant Thermoplastic) to ensure tracking resistance and to avoid any insulation damage to covered conductor due to abrasion while mechanical or wind induced vibration. Plastic coated metallic ties are not allowed.

## 5.3 MECHANICAL CONNECTOR WITH HEAT SHRINK SLEEVE:

It is used for main (Bare) to main (Covered Conductor) networking Connection. This connector is to ensure the electrical characteristics with in the required limits, while ensuring necessary insulation protection against tracking and water penetration on Covered Conductor. The body as well as the shear head screws of the mechanical connector should be made of aluminum alloy. It should have a centered bore with tapered edges and a moisture block barrier in the center of the tube. Heat shrink sleeve shall be rated for up to 33 kV.

## 5.4 INSULATION PIERCING CONNECTOR:

Insulation Piercing Connectors (IPC) are used for making Tee / Tap-off/ connections to a Covered Conductor. Insulation Piercing Connectors are designed to make a connection between the uncut main conductor and a branch cable conductor without having to strip either



 TP CODL TP CENTRAL ODISHA DISTRIBUTION LIMITED	TP CENTRAL ODISHA DISTRIBUTION LIMITED, BHUBANESWAR		
	TECHNICAL SPECIFICATION		
Document Title	<b>SPECIFICATION FOR ACCESSORIES OF 33kV XLPE COVERED CONDUCTOR</b>		
Document No.	ENG-ELC-072	Issue Date: 13.05.2022	
Revision No.	00	Page 7 of 18	
Prepared by: Barsha Bandita	Reviewed By: Jeevan Sangram	Approved By: Khajan C. Bhardwaj	Issued By: Pourush Garg

cable to expose the conductor. Instead, the tightening action of the IPC will first pierce the Insulation, then make good electrical contact between the main and branch conductor while simultaneously insulating and sealing the connection. The connector bodies shall be made entirely of mechanical and weather resistant plastic insulation material made of weather & UV resistant reinforced polymer and no metallic part outside the housing is acceptable except for the tightening bolt or nuts.

Any metallic part that is exposed must be free from potential during or after connector installation.

Screws or nuts assigned for fitting with IPC (Insulating Piercing connector), must be fitted with torque limiting shear heads to prevent over tightening or under tightening.

The min & max torque values should not exceed 27 N mtr for IPC for main conductor < 95 sq mm, and 42 Nmtr for main conductor >95, but < 240 sq mm.

The contact teeth or blade of the connector is made of tinned copper with equivalent Cross Section with respect to % IACS to suit the max branch cable size declared. The shear bolt/nut shall be suitable for tightening with a hexagonal socket of 13 mm or 17mm.

The IPCs shall be water proof and the water tightness shall be ensured by appropriate elastomeric materials and not by grease, gel or paste alone. Grease can be applied to protect the contact blade alone and shall not be visible on the outer surface of the connector. Connector should not be dipped in grease.

Each IPC should be provided with a cap to seal the cut end of the Branch cable. It should be of a design that once the connector is installed, it should not be possible to remove the cap without dismantling the connector.

All the metallic parts of the connector should be corrosion resistant and there should not be any appreciable change in contact resistance & temperature after overloads & load cycling and should confirm to the long duration tests specified in this standard.

## 5.5 MID SPAN JOINTS:

Mid-span tension joints for jointing covered conductor over a span. The sleeves should be Pre-Insulated type. Sleeve should be made of Aluminum, insulated with an Anti-UV black thermoplastic tube hermetically sealed two ends with 2 flexible rings. Strip length, Hexagonal crimping die reference and size to be marked on the outer surface of plastic sleeve.

## 5.6 ARC PROTECTION DEVICES:

Arching Horn Assembly is an Arc protection device for power arc evacuation without insulator

 TP CODL TP CENTRAL ODISHA DISTRIBUTION LIMITED	TP CENTRAL ODISHA DISTRIBUTION LIMITED, BHUBANESWAR		
	TECHNICAL SPECIFICATION		
Document Title	SPECIFICATION FOR ACCESSORIES OF 33kV XLPE COVERED CONDUCTOR		
Document No.	ENG-ELC-072	Issue Date: 13.05.2022	
Revision No.	00	Page 8 of 18	
Prepared by: Barsha Bandita	Reviewed By: Jeevan Sangram	Approved By: Khajan C. Bhardwaj	Issued By: Pourush Garg

damage. The arching Horn Assembly protection device consists of:

- a) Two arcing horns with adjustable distance “L” directly mounted on the insulator terminals.
- b) A covered conductor with clamp on the horn side.
- c) An insulation piercing connector on the main cable side.

## 6. MARKING:

The following particulars shall be properly legible embossed/Printing on the accessories.

- a) Name & Trade mark of the manufacturer
- b) Product Code
- c) Batch Number
- d) The minimum and maximum cross section of Conductor for which the unit is suitable
- e) Month and Year of Manufacturer
- f) “TPCODL” Name

## 7. TESTS

A type test shall be performed on the accessories. All the Acceptance test, Type test and Routine test should be as per EN 50397-2 and latest amendment. The bidder shall be required to submit complete set of the following test reports along with the offer: -

### 7.1 ACCEPTANCE TESTS

#### i) Tension Assembly-Wedge Type (TA)

- a) Visual examination
- b) Dimension verification
- c) Tensile test at ambient temperature
- d) Check for permanent marking

#### ii) Non Metallic Alignment Ties

- a) Visual examination
- b) Dimension verification
- c) Check for permanent marking
- d) Failure Load Tests
- e) Slip Load Tests
- f) Lift / Side Load Tests

#### iii) Mechanical Connector With Heat Shrink Sleeve

- a) Visual examination

 TP CENTRAL ODISHA DISTRIBUTION LIMITED	TP CENTRAL ODISHA DISTRIBUTION LIMITED, BHUBANESWAR		
	TECHNICAL SPECIFICATION		
Document Title	SPECIFICATION FOR ACCESSORIES OF 33KV XLPE COVERED CONDUCTOR		
Document No.	ENG-ELC-072	Issue Date: 13.05.2022	
Revision No.	00	Page 9 of 18	
Prepared by: Barsha Bandita	Reviewed By: Jeevan Sangram	Approved By: Khajan C. Bhardwaj	Issued By: Pourush Garg

- b) Dimension verification
- c) Check for permanent marking
- d) Mechanical Test
- e) Water Tightness test

**iv) Insulation Piercing Connector**

- a) Visual examination
- b) Dimension verification
- c) Check for permanent marking
- d) Mechanical Test

**v) Mid Span Joints**

- a) Visual examination
- b) Dimension verification
- c) Check for permanent marking
- d) Mechanical Test

**vi) Arc Protection Devices**

- a) Visual examination
- b) Dimension verification
- c) Check for permanent marking
- d) Clamp Bolt Tightening Test
- e) Short Circuit test

**7.2 ROUTINE TESTS**

**i) Tension Assembly-Wedge Type (TA)**

- a) Visual examination
- b) Dimension verification

**ii) Non Metallic Alignment Ties**

- a) Visual examination
- b) Dimension verification
- c) Check for permanent marking
- d) Failure Load Tests
- e) Slip Load Tests
- f) Lift / Side Load Tests

 TP CODL TP CENTRAL ODISHA DISTRIBUTION LIMITED	TP CENTRAL ODISHA DISTRIBUTION LIMITED, BHUBANESWAR		
	TECHNICAL SPECIFICATION		
Document Title	SPECIFICATION FOR ACCESSORIES OF 33kV XLPE COVERED CONDUCTOR		
Document No.	ENG-ELC-072	Issue Date: 13.05.2022	
Revision No.	00	Page 10 of 18	
Prepared by: Barsha Bandita	Reviewed By: Jeevan Sangram	Approved By: Khajan C. Bhardwaj	Issued By: Pourush Garg

### iii) Mechanical Connector With Heat Shrink Sleeve

- a) Visual examination
- b) Dimension verification
- c) Check for permanent marking
- d) Mechanical Test

### iv) Insulation Piercing Connector

- a) Visual examination
- b) Dimension verification
- c) Check for permanent marking
- d) Mechanical Test

### v) Mid Span Joints

- a) Visual examination
- b) Dimension verification
- c) Check for permanent marking
- d) Mechanical Test

### vi) Arc Protection Devices

- a) Visual examination
- b) Dimension verification
- c) Check for permanent marking
- d) Clamp Bolt Tightening Test

## 7.3 TYPE TESTS

### i) Tension Assembly-Wedge Type (TA)

- g) Visual examination
- h) Dimension verification
- i) Tensile test at ambient temperature
- j) Tensile test at low temperature
- k) Tensile test at high temperature
- l) Corrosion test
- m) Climate ageing test
- n) Check for permanent marking

 TP CODL TP CENTRAL ODISHA DISTRIBUTION LIMITED	TP CENTRAL ODISHA DISTRIBUTION LIMITED, BHUBANESWAR		
	TECHNICAL SPECIFICATION		
Document Title	SPECIFICATION FOR ACCESSORIES OF 33KV XLPE COVERED CONDUCTOR		
Document No.	ENG-ELC-072	Issue Date: 13.05.2022	
Revision No.	00	Page 11 of 18	
Prepared by: Barsha Bandita	Reviewed By: Jeevan Sangram	Approved By: Khajan C. Bhardwaj	Issued By: Pourush Garg

**ii) Non Metallic Alignment Ties**

- a) Visual examination
- b) Dimension verification
- c) Check for permanent marking
- d) Failure Load Tests
- e) Slip Load Tests
- f) Lift / Side Load Tests
- g) Thermal Tests under load
- h) Corrosion test
- i) Climate ageing test

**iii) Mechanical Connector With Heat Shrink Sleeve**

- a) Visual examination
- b) Dimension verification
- c) Check for permanent marking
- d) Mechanical Test
- e) Water Tightness test
- f) Climatic Ageing Test
- g) Corrosion Test
- h) Electrical Ageing Test

**iv) Insulation Piercing Connector**

- a) Visual examination
- b) Dimension verification
- c) Check for permanent marking
- d) Mechanical Test
- e) Water Tightness test
- f) Climatic Ageing Test
- g) Corrosion Test
- h) Electrical Ageing Test

**v) Mid Span Joints**

- a) Visual examination
- b) Dimension verification
- c) Check for permanent marking
- d) Mechanical Test
- e) Water Tightness test

 TP CODL TP CENTRAL ODISHA DISTRIBUTION LIMITED	TP CENTRAL ODISHA DISTRIBUTION LIMITED, BHUBANESWAR		
	TECHNICAL SPECIFICATION		
Document Title	SPECIFICATION FOR ACCESSORIES OF 33kV XLPE COVERED CONDUCTOR		
Document No.	ENG-ELC-072	Issue Date: 13.05.2022	
Revision No.	00	Page 12 of 18	
Prepared by: Barsha Bandita	Reviewed By: Jeevan Sangram	Approved By: Khajan C. Bhardwaj	Issued By: Pourush Garg

f) Climatic Ageing Test

g) Corrosion Test

**vi) Arc Protection Devices**

a) Visual examination

b) Dimension verification

c) Check for permanent marking

d) Clamp Bolt Tightening Test

e) Short Circuit test

**8. TYPE TEST CERTIFICATES:**

The Bidder shall furnish the type test certificates of the tests as mentioned above as per the corresponding standards. All the tests shall be conducted at **CPRI/ERDA or any government lab** as per the relevant IS/IEC. Type tests should have been conducted in certified Test laboratories during the period not exceeding 5 years from the date of opening the bid. In the event of any discrepancy in the test reports, i.e. any test report not acceptable, same shall be carried out without any cost implication to TPCODL.

**9. PRE DISPATCH INSPECTION:**

The material shall be subject to inspection by a duly authorized representative of the TPCODL. Inspection may be made at any stage of manufacture at the discretion of the purchaser and the equipment, if found unsatisfactory as to workmanship or material, the same is liable to rejection. Bidder shall grant free access to the places of manufacture to TPCODL's representatives at all times when the work is in progress. Inspection by the TPCODL or its authorized representatives shall not relieve the bidder of his obligation of furnishing equipment in accordance with the specifications. Material shall be dispatched after specific MDCC (Material Dispatch Clearance Certificate) is issued by TPCODL.

Following documents shall be sent along with material.

a) Test reports

b) MDCC issued by TPCODL

c) Invoice in duplicate

d) Packing list

e) Drawings & catalogue

f) Guarantee / Warrantee card

g) Delivery Challan

h) Other Documents (as applicable).

 TP CODL TP CENTRAL ODISHA DISTRIBUTION LIMITED	TP CENTRAL ODISHA DISTRIBUTION LIMITED, BHUBANESWAR		
	TECHNICAL SPECIFICATION		
Document Title	<b>SPECIFICATION FOR ACCESSORIES OF 33kV XLPE COVERED CONDUCTOR</b>		
Document No.	ENG-ELC-072	Issue Date: 13.05.2022	
Revision No.	00	Page 13 of 18	
Prepared by: Barsha Bandita	Reviewed By: Jeevan Sangram	Approved By: Khajan C. Bhardwaj	Issued By: Pourush Garg

#### 10. INSPECTION AFTER RECEIPT AT STORES:

The material received at TPCODL, Odisha store will be inspected for acceptance and shall be liable for rejection, if found different from the reports of the pre-dispatch inspection and one copy of the report shall be sent to Engineering department.

#### 11. GUARANTEE:

Bidder shall stand guarantee towards design, materials, workmanship & quality of process/ manufacturing of items under the contract for due and intended performance of the same, as an integrated product delivered under this contract. In the event any defect is found by the Company up to a period of 24 months from the date of commissioning or 30 months from the date of last supplies made under the contract, whichever is earlier, supplier shall be liable to undertake to replace/rectify such defects at his own costs. within mutually agreed timeframe, and to the entire satisfaction of the Company, failing which the Company will be at liberty to get it replaced/rectified at supplier's risks and costs and recover all such expenses plus the Company's own charges (@ 20% of expenses incurred), from the supplier or from the "Security cum Performance Deposit" as the case may be.

The bidder shall further be responsible for 'free replacement' for another period of THREE years from the end of guarantee period for any 'latent defects' if noticed by the company.

#### 12. PACKING:

Supplier shall ensure that all the equipment covered under this specification shall be prepared for rail/road transport and be packed in such a manner so as to protect the equipment from damage in transit. The material used for packing shall be environmentally friendly. The bidder shall provide instructions regarding handling and storage precautions to be taken at site.

#### 13. TENDER SAMPLE:

Bidder shall submit the sample of material during submission of Bids.

#### 14. QUALITY CONTROL:

The bidder shall submit with the offer Quality Assurance Plan indicating the various stages of inspection, the tests and checks which will be carried out on the material of construction, components during manufacture and bought out items and fully assembled component and equipment after finishing. As part of the plan, a schedule for stage and final inspection within the parameters of the delivery schedule shall be furnished. The Purchaser's engineer or its nominated representative shall have free access to the manufacturer's/sub-supplier's works to carry out inspections. The bidder shall ensure that the material supplied is as per the Guaranteed Technical Particulars as specified in the specifications.

 TP CODL TP CENTRAL ODISHA DISTRIBUTION LIMITED	TP CENTRAL ODISHA DISTRIBUTION LIMITED, BHUBANESWAR		
	TECHNICAL SPECIFICATION		
Document Title	<b>SPECIFICATION FOR ACCESSORIES OF 33kV XLPE COVERED CONDUCTOR</b>		
Document No.	ENG-ELC-072	Issue Date: 13.05.2022	
Revision No.	00	Page 14 of 18	
Prepared by: Barsha Bandita	Reviewed By: Jeevan Sangram	Approved By: Khajan C. Bhardwaj	Issued By: Pourush Garg

## 15. TESTING FACILITIES:

Bidder shall have adequate in-house testing facilities for carrying out all routine tests & acceptance tests as per relevant International / Indian standards.

## 16. MANUFACTURING ACTIVITIES:

The successful bidder will have to submit the bar chart for various manufacturing activities clearly elaborating each stage, with quantity. This bar chart should be in line with the Quality assurance plan submitted with the offer.

## 17. SPARES, ACCESSORIES AND TOOLS

Not applicable.

## 18. DRAWINGS AND DOCUMENTS

Following drawings and documents shall be submitted in line with the requirement of Tender specifications:

- Completely filled in Schedule "A" Guaranteed Technical Particulars & Schedule "B" Deviations
- Work Experience details
- Type test certificates.
- Drawing 1 set of Hard Copy & Soft copy PDF File containing complete information about manufacturing.

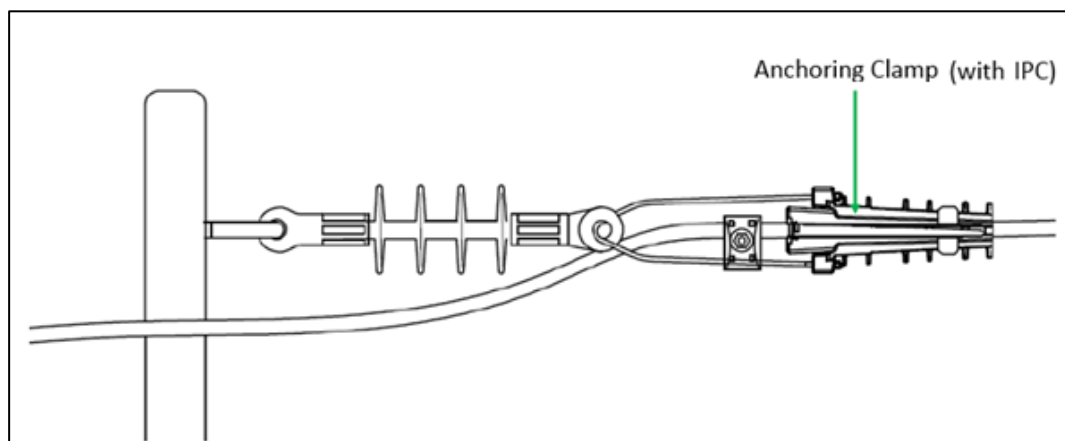



Fig.1:- Tension Assembly (TA) with Anchoring clamp and one Tracking protection IPC



 TP CODL TP CENTRAL ODISHA DISTRIBUTION LIMITED	TP CENTRAL ODISHA DISTRIBUTION LIMITED, BHUBANESWAR		
	TECHNICAL SPECIFICATION		
Document Title	<b>SPECIFICATION FOR ACCESSORIES OF 33KV XLPE COVERED CONDUCTOR</b>		
Document No.	ENG-ELC-072	Issue Date: 13.05.2022	
Revision No.	00	Page 15 of 18	
Prepared by: Barsha Bandita	Reviewed By: Jeevan Sangram	Approved By: Khajan C. Bhardwaj	Issued By: Pourush Garg

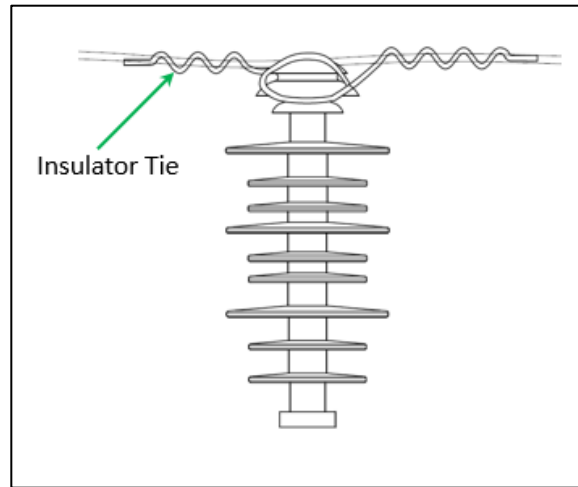

Fig.2:- Non Metallic Alignment Tie

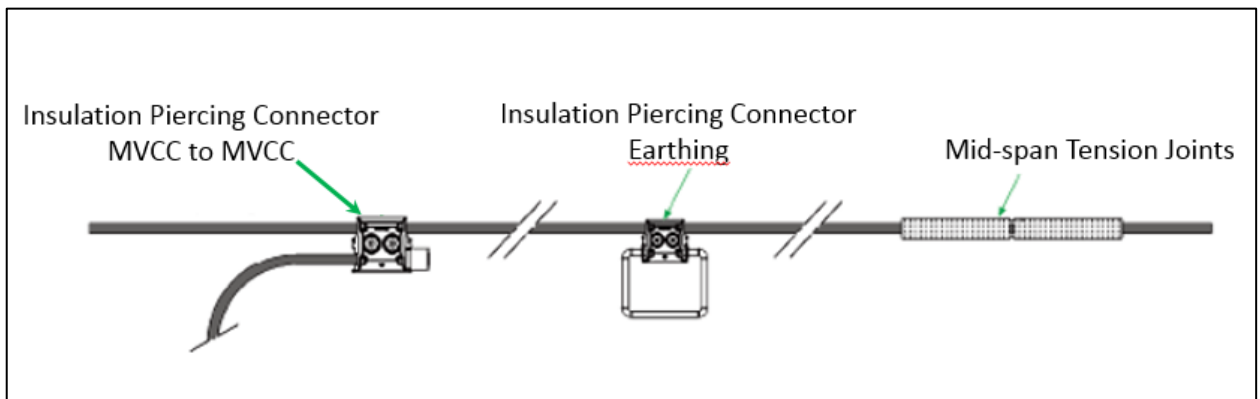

Fig.3:- Insulation Piercing Connector for Networking / Branching / Looping and Midspan Joints

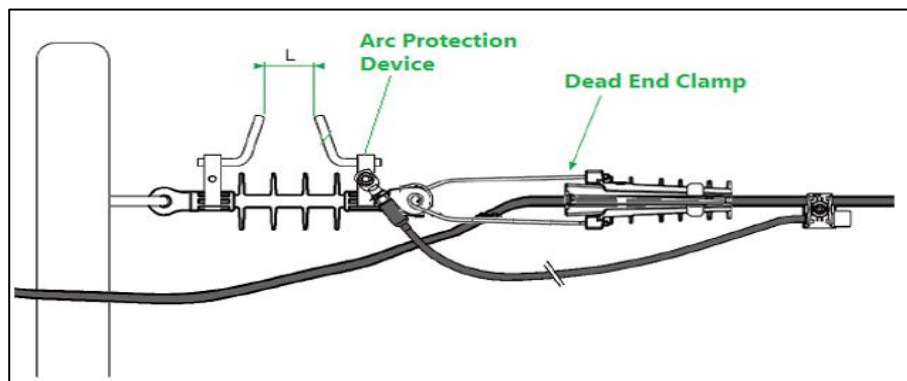



Fig.4:- Arc Protection Device

Note:- These are the Sample Drawing for tender purpose only.

 TP CENTRAL ODISHA DISTRIBUTION LIMITED	TP CENTRAL ODISHA DISTRIBUTION LIMITED, BHUBANESWAR		
	TECHNICAL SPECIFICATION		
Document Title	SPECIFICATION FOR ACCESSORIES OF 33KV XLPE COVERED CONDUCTOR		
Document No.	ENG-ELC-072	Issue Date: 13.05.2022	
Revision No.	00	Page 16 of 18	
Prepared by: Barsha Bandita	Reviewed By: Jeevan Sangram	Approved By: Khajan C. Bhardwaj	Issued By: Pourush Garg

## 19. SCHEDULE- "A" GUARANTEED TECHNICAL PARTICULARS

### TENSION ASSEMBLY-WEDGE TYPE (TA)

Sl. No.	Technical Parameters	To Be Furnished By The Bidder
1	Name of the manufacturer	
2	Applicable Standard	
3	Range of Conductor size	
4	Installation(with/without disassembly)	
5	Type & grade	
6	Application	
7	Mechanical Strength	
8	Dimensions (mm)	

### NON METALLIC ALIGNMENT TIES

Sl. No.	Technical Parameters	To Be Furnished By The Bidder
1	Name of the manufacturer	
2	Applicable Standard	
3	Range of Conductor size	
4	Mounting	
5	Type	
6	Material	
7	Application	
8	Dimensions (mm)	

### MECHANICAL CONNECTOR WITH HEAT SHRINK SLEEVE

Sl. No.	Technical Parameters	To Be Furnished By The Bidder
1	Name of the manufacturer	
2	Applicable Standard	
3	Range of Conductor size	
4	Installation	
5	Type of connection required	
6	Is any metallic part carrying potential in operation exposed during installation	

 TP CODL TP CENTRAL ODISHA DISTRIBUTION LIMITED	TP CENTRAL ODISHA DISTRIBUTION LIMITED, BHUBANESWAR		
	<b>TECHNICAL SPECIFICATION</b>		
<b>Document Title</b>	<b>SPECIFICATION FOR ACCESSORIES OF 33KV XLPE COVERED CONDUCTOR</b>		
<b>Document No.</b>	ENG-ELC-072	<b>Issue Date: 13.05.2022</b>	
<b>Revision No.</b>	00	<b>Page 17 of 18</b>	
<b>Prepared by:</b> Barsha Bandita	<b>Reviewed By:</b> Jeevan Sangram	<b>Approved By:</b> Khajan C. Bhardwaj	<b>Issued By:</b> Pourush Garg

Sl. No.	Technical Parameters	To Be Furnished By The Bidder
7	Material	
8	Connector ID	

### INSULATION PIERCING CONNECTOR

Sl. No.	Technical Parameters	To Be Furnished By The Bidder
1	Name of the manufacturer	
2	Applicable Standard	
3	Range of Conductor sizes accommodated for Main & Branch	
4	Application	
5	Type of connection required	
6	Is any metallic part carrying potential in operation exposed during installation	
7	Are end caps of branch cable a) Slide on type (b) Rigid	
8	Are torque limiting shear heads provided to tightening bolts	
9	Specified Torque	
10	Torque for establishing connection between main and Tap (Nm)	

### MID SPAN JOINTS

Sl. No.	Technical Parameters	To Be Furnished By The Bidder
1	Name of the manufacturer	
2	Applicable Standard	
3	Type No & Size Range	
4	Application	
5	Type of connection required	
6	Is any metallic part carrying potential in operation exposed during installation	
7	Installation	

 <b>TPCODL</b> <small>TP CENTRAL ODISHA DISTRIBUTION LIMITED</small>	TP CENTRAL ODISHA DISTRIBUTION LIMITED, BHUBANESWAR		
	<b>TECHNICAL SPECIFICATION</b>		
<b>Document Title</b>	<b>SPECIFICATION FOR ACCESSORIES OF 33kV XLPE COVERED CONDUCTOR</b>		
<b>Document No.</b>	ENG-ELC-072	<b>Issue Date: 13.05.2022</b>	
<b>Revision No.</b>	00	<b>Page 18 of 18</b>	
<b>Prepared by:</b> Barsha Bandita	<b>Reviewed By:</b> Jeevan Sangram	<b>Approved By:</b> Khajan C. Bhardwaj	<b>Issued By:</b> Pourush Garg

**20. SCHEDULE “B” DEVIATIONS:**

**(TO BE ENCLOSED WITH TECHNICAL BID)**

All deviations from this specification shall be set out by the Bidders, clause by Clause in this schedule. Unless specifically mentioned in this Schedule, the tender shall be deemed to confirm the purchaser's specifications:

SL. No	Clause No.	Details of deviation with justifications

We confirm that there are no deviations apart from those detailed above.

Seal of the Company:

Signature

Designation

 <b>TPCODL</b> <small>TP CENTRAL ODISHA DISTRIBUTION LIMITED</small>	<b>TP CENTRAL ODISHA DISTRIBUTION LIMITED, BHUBANESWAR</b>		
	<b>TECHNICAL SPECIFICATION</b>		
<b>Document Title</b>	<b>SPECIFICATION FOR ACCESSORIES OF 11KV XLPE COVERED CONDUCTOR</b>		
<b>Document No.</b>	ENG-ELC-071	<b>Issue Date: 13.05.2022</b>	
<b>Revision No.</b>	00	<b>Page 1 of 18</b>	
<b>Prepared by:</b> Jeevan Sangram	<b>Reviewed By:</b> Barsha Bandita	<b>Approved By:</b> Khajan C. Bhardwaj	<b>Issued By:</b> Pourush Garg

## **CONTENTS**

1. SCOPE
2. APPLICABLE STANDARDS
3. CLIMATIC CONDITIONS OF THE INSTALLATION
4. GENERAL TECHNICAL REQUIREMENTS
5. GENERAL CONSTRUCTIONS
6. MARKING
7. TESTS
8. TYPE TEST CERTIFICATES
9. PRE-DISPATCH INSPECTION
10. INSPECTION AFTER RECEIPT AT STORES
11. GUARANTEE
12. PACKING
13. TENDER SAMPLE
14. QUALITY CONTROL
15. TESTING FACILITIES
16. MANUFACTURING ACTIVITIES
17. SPARES, ACCESSORIES AND TOOLS
18. DRAWINGS AND DOCUMENTS
19. SCHEDULE "A" GUARANTEED TECHNICAL PARTICULARS
20. SCHEDULE "B" DEVIATIONS

 TP CODL TP CENTRAL ODISHA DISTRIBUTION LIMITED	TP CENTRAL ODISHA DISTRIBUTION LIMITED, BHUBANESWAR		
	TECHNICAL SPECIFICATION		
Document Title	SPECIFICATION FOR ACCESSORIES OF 11kV XLPE COVERED CONDUCTOR		
Document No.	ENG-ELC-071	Issue Date: 13.05.2022	
Revision No.	00	Page 2 of 18	
Prepared by: Jeevan Sangram	Reviewed By: Barsha Bandita	Approved By: Khajan C. Bhardwaj	Issued By: Pourush Garg

## 1. SCOPE

This specification covers the technical requirements of design, manufacture, testing at manufacturer's works, packing, forwarding, supply and unloading at site/store of Accessories for All Aluminum Alloy Stranded XLPE Covered Conductors for use on 11 kV Distribution System.

## 2. APPLICABLE STANDARDS

The equipment covered by this specification shall unless otherwise stated, be designed, manufactured and tested in accordance with the latest editions of the following Indian, International Standards and shall conform to the regulations of the local authorities:

Ref. IS	Description
EN 50397-1:2006	Covered Conductor Specification- Up to 33 kV
EN 50397-2:2006	Covered Conductor Accessories Specification- up to 33 kV
EN 50397-2 (MARCH 2010)	Covered conductors for overhead lines and the related accessories for rated voltages above 1kV a.c. and not exceeding 36kV a.c. PART 2: Accessories for covered conductors : tests and acceptance criteria
IS 398:1996 (Part IV)	Specification for aluminum conductors for overhead distribution purpose
EN 61238-1: 2003	Compression and mechanical connectors for power cables for rated voltages up to 36 kV Test methods and requirements
ANSI C119.4 :2011	Electric Connectors - Connectors For Use Between Aluminum-To-Aluminum And Aluminum-To-Copper Conductors Designed For Normal Operation At Or Below 93 °C And Copper-To-Copper Conductors Designed For Normal Operation At Or Below 100 °C

 TP CODL TP CENTRAL ODISHA DISTRIBUTION LIMITED	TP CENTRAL ODISHA DISTRIBUTION LIMITED, BHUBANESWAR		
	TECHNICAL SPECIFICATION		
Document Title	<b>SPECIFICATION FOR ACCESSORIES OF 11KV XLPE COVERED CONDUCTOR</b>		
Document No.	ENG-ELC-071	Issue Date: 13.05.2022	
Revision No.	00	Page 3 of 18	
Prepared by: Jeevan Sangram	Reviewed By: Barsha Bandita	Approved By: Khajan C. Bhardwaj	Issued By: Pourush Garg

### 3. CLIMATIC CONDITIONS OF THE INSTALLATION:

1	Maximum ambient temperature	50 deg C
2	Max. Daily average ambient temp	35 deg C
3	Min Ambient Temperature	0 deg C
4	Maximum Humidity	95%
5	Average Annual Rainfall	150cm
6	Average No. of rainy days per annum	120
7	Altitude above MSL not exceeding	1000m
8	Wind Pressure	300 Km/hr
9	Earthquakes of an intensity in horizontal direction	equivalent to seismic acceleration of 0.3g
10	Earthquakes of an intensity in vertical direction	equivalent to seismic acceleration of 0.15g (g being acceleration due to gravity)

TPCODL service area has heavy saline conditions along the coast and High cyclonic Intensity winds with speed upto 300 Kmph. The atmosphere is generally laden with mild acid and dust in suspension during the dry months and is subjected to fog in cold months.

### 4. GENERAL TECHNICAL REQUIREMENTS:

The Accessories of 11 kV XLPE Covered Conductor are specified below and shall consist of the following:

#### 4.1 TENSION ASSEMBLY-WEDGE TYPE (TA)

Sl. No.	Technical Parameters	Desired Values
1	Name of the manufacturer	To be furnished by bidder
2	Applicable Standard	EN 50397-2
3	Range of Conductor size	50 Sq.mm to 240 Sq.mm
4	Installation(with/without disassembly)	Ready-to-use (without disassembly)
5	Type & grade	Heat treated aluminium Alloy for Body and Weather resistant Thermoplastic for wedge
6	Application	11 kV

 TP CODL TP CENTRAL ODISHA DISTRIBUTION LIMITED	TP CENTRAL ODISHA DISTRIBUTION LIMITED, BHUBANESWAR		
	<b>TECHNICAL SPECIFICATION</b>		
<b>Document Title</b>	<b>SPECIFICATION FOR ACCESSORIES OF 11KV XLPE COVERED CONDUCTOR</b>		
<b>Document No.</b>	ENG-ELC-071	<b>Issue Date: 13.05.2022</b>	
<b>Revision No.</b>	00	<b>Page 4 of 18</b>	
<b>Prepared by:</b> Jeevan Sangram	<b>Reviewed By:</b> Barsha Bandita	<b>Approved By:</b> Khajan C. Bhardwaj	<b>Issued By:</b> Pourush Garg

Sl. No.	Technical Parameters	Desired Values
7	Mechanical Strength	To be furnished by the Bidder for each type of conductor
7	Dimensions (mm)	To be furnished by bidder

#### 4.2 NON METALLIC ALIGNMENT TIES

Sl. No.	Technical Parameters	Desired Values
1	Name of the manufacturer	To be furnished by bidder
2	Applicable Standard	EN 50397-2
3	Range of Conductor size	50 Sq.mm to 240 Sq.mm
4	Mounting	Can mount directly on cable without any accessories
5	Type	Top Tie
6	Material	UV Resistant Thermoplastic
7	Application	11 kV
8	Dimensions (mm)	To be furnished by bidder

#### 4.3 MECHANICAL CONNECTOR WITH HEAT SHRINK SLEEVE

Sl. No.	Technical Parameters	Desired Values
1	Name of the manufacturer	To be furnished by bidder
2	Applicable Standard	IEC 61238-1
3	Range of Conductor size	For Phase conductor of diameter range 50-240 sq.mm
4	Installation	Crimping by shear head bolt compression
5	Type of connection required	Connection by compression pressure
6	Is any metallic part carrying potential in operation exposed during installation	No
7	Material	Aluminium Alloy For mechanical connector UV resistant polymer for heat shrink sleeve
8	Connector ID	Ø 14 mm to Ø 33 mm

#### 4.4 INSULATION PIERCING CONNECTOR

Sl. No.	Technical Parameters	Desired Values
1	Name of the manufacturer	To be furnished by bidder



 TP CODL TP CENTRAL ODISHA DISTRIBUTION LIMITED	TP CENTRAL ODISHA DISTRIBUTION LIMITED, BHUBANESWAR		
	TECHNICAL SPECIFICATION		
Document Title	<b>SPECIFICATION FOR ACCESSORIES OF 11KV XLPE COVERED CONDUCTOR</b>		
Document No.	ENG-ELC-071	Issue Date: 13.05.2022	
Revision No.	00	Page 5 of 18	
Prepared by: Jeevan Sangram	Reviewed By: Barsha Bandita	Approved By: Khajan C. Bhardwaj	Issued By: Pourush Garg

Sl. No.	Technical Parameters	Desired Values
2	Applicable Standard	EN 50397-2
3	Range of Conductor sizes accommodated for Main & Branch	Main : 50 - 240 sq.mm Tap : 50 - 240 sq.mm
4	Application	33 kV
5	Type of connection required	Insulation Piercing Type (Covered to Covered)
6	Is any metallic part carrying potential in operation exposed during installation	No
7	Are end caps of branch cable a) Slide on type (b) Rigid	Slide on type
8	Are torque limiting shear heads provided to tightening bolts	Yes
9	Specified Torque	18±1.5 Nm
10	Torque for establishing connection between main and Tap (Nm)	Within 70% of Min. Torque specified

#### 4.5 MID SPAN JOINTS

Sl. No.	Technical Parameters	Desired Values
1	Name of the manufacturer	To be furnished by bidder
2	Applicable Standard	EN 50483-4
3	Type No & Size Range	For Phase conductor of 50 Sq.mm to 240 sq. mm
4	Application	11 kV
5	Type of connection required	Crimping type
6	Is any metallic part carrying potential in operation exposed during installation	No
7	Installation	Crimping by Hexagonal Compression

#### 5. GENERAL CONSTRUCTIONS:

##### 5.1 TENSION ASSEMBLY-WEDGE TYPE (TA)

For fitting onto a pole for tensioning at the beginning or end of a length of Covered Conductor, or for anchoring while a major change in direction. The Tension assembly consists of one wedge type Tension anchoring clamp and one Tracking protection IPC.

 TP CODL TP CENTRAL ODISHA DISTRIBUTION LIMITED	TP CENTRAL ODISHA DISTRIBUTION LIMITED, BHUBANESWAR		
	TECHNICAL SPECIFICATION		
Document Title	<b>SPECIFICATION FOR ACCESSORIES OF 11KV XLPE COVERED CONDUCTOR</b>		
Document No.	ENG-ELC-071	Issue Date: 13.05.2022	
Revision No.	00	Page 6 of 18	
Prepared by: Jeevan Sangram	Reviewed By: Barsha Bandita	Approved By: Khajan C. Bhardwaj	Issued By: Pourush Garg

The following key criterion to be followed for the design of the same:-

- a) There shall be no losable part (except Tracking IPC) in the process of clamping arrangement.
- b) The clamp should consist of an Aluminum alloy corrosion resistant casted body and self-adjusting fully insulating type of mechanical and weather resisting thermoplastic wedges which shall anchor/hold the conductor.
- c) Locking mechanism should be wedge type self-locking. Wedges are to be made of high strength, climatic resistance Engineering Plastic with glass fiber.
- d) The fittings shall be able to withstand the specific minimum failure load (SMFL) and shall not damage the covering of cable. SMFL is the minimum failure load for clamp at which mechanical failure will not take place.
- e) No tools shall be needed for fitting the Covered Conductor into the clamp.
- f) The Anchoring clamp shall have an IPC to avoid tracking phenomenon by maintaining the metallic clamp as well as the cable passing through it at equipotential.

## 5.2 NON METALLIC ALIGNMENT TIES:

For supporting and aligning Covered Conductor at an intermediate pole in a length, with small angle of deviation. The Tie hold the Covered Conductor in its position on top of the pin insulator. Tie consists of an “Insulated Plastic” Type for Lin Alignment. The ties shall be designed suitably to hold the Covered Conductor in its position on top of the insulator. The Tie shall be made of Insulating Plastic materials (UV Resistant Thermoplastic) to ensure tracking resistance and to avoid any insulation damage to covered conductor due to abrasion while mechanical or wind induced vibration. Plastic coated metallic ties are not allowed.

## 5.3 MECHANICAL CONNECTOR WITH HEAT SHRINK SLEEVE:

It is used for main (Bare) to main (Covered Conductor) networking Connection. This connector is to ensure the electrical characteristics with in the required limits, while ensuring necessary insulation protection against tracking and water penetration on Covered Conductor. The body as well as the shear head screws of the mechanical connector should be made of aluminum alloy. It should have a centered bore with tapered edges and a moisture block barrier in the center of the tube. Heat shrink sleeve shall be rated for up to 11 kV.

## 5.4 INSULATION PIERCING CONNECTOR:

Insulation Piercing Connectors (IPC) are used for making Tee / Tap-off/ connections to a Covered Conductor. Insulation Piercing Connectors are designed to make a connection between the uncut main conductor and a branch cable conductor without having to strip either

 TP CODL TP CENTRAL ODISHA DISTRIBUTION LIMITED	TP CENTRAL ODISHA DISTRIBUTION LIMITED, BHUBANESWAR		
	TECHNICAL SPECIFICATION		
Document Title	<b>SPECIFICATION FOR ACCESSORIES OF 11KV XLPE COVERED CONDUCTOR</b>		
Document No.	ENG-ELC-071	Issue Date: 13.05.2022	
Revision No.	00	Page 7 of 18	
Prepared by: Jeevan Sangram	Reviewed By: Barsha Bandita	Approved By: Khajan C. Bhardwaj	Issued By: Pourush Garg

cable to expose the conductor. Instead, the tightening action of the IPC will first pierce the Insulation, then make good electrical contact between the main and branch conductor while simultaneously insulating and sealing the connection. The connector bodies shall be made entirely of mechanical and weather resistant plastic insulation material made of weather & UV resistant reinforced polymer and no metallic part outside the housing is acceptable except for the tightening bolt or nuts.

Any metallic part that is exposed must be free from potential during or after connector installation.

Screws or nuts assigned for fitting with IPC (Insulating Piercing connector), must be fitted with torque limiting shear heads to prevent over tightening or under tightening.

The min & max torque values should not exceed 27 N mtr for IPC for main conductor < 95 sq mm, and 42 Nmtr for main conductor >95, but < 240 sq mm.

The contact teeth or blade of the connector is made of tinned copper with equivalent Cross Section with respect to % IACS to suit the max branch cable size declared. The shear bolt/nut shall be suitable for tightening with a hexagonal socket of 13 mm or 17mm.

The IPCs shall be water proof and the water tightness shall be ensured by appropriate elastomeric materials and not by grease, gel or paste alone. Grease can be applied to protect the contact blade alone and shall not be visible on the outer surface of the connector. Connector should not be dipped in grease.

Each IPC should be provided with a cap to seal the cut end of the Branch cable. It should be of a design that once the connector is installed, it should not be possible to remove the cap without dismantling the connector.

All the metallic parts of the connector should be corrosion resistant and there should not be any appreciable change in contact resistance & temperature after overloads & load cycling and should confirm to the long duration tests specified in this standard.

## 5.5 MID SPAN JOINTS:

Mid-span tension joints for jointing covered conductor over a span. The sleeves should be Pre-Insulated type. Sleeve should be made of Aluminum, insulated with an Anti-UV black thermoplastic tube hermetically sealed two ends with 2 flexible rings. Strip length, Hexagonal crimping die reference and size to be marked on the outer surface of plastic sleeve.

## 5.6 ARC PROTECTION DEVICES:

Arching Horn Assembly is an Arc protection device for power arc evacuation without insulator

 TP CODL TP CENTRAL ODISHA DISTRIBUTION LIMITED	TP CENTRAL ODISHA DISTRIBUTION LIMITED, BHUBANESWAR		
	TECHNICAL SPECIFICATION		
Document Title	<b>SPECIFICATION FOR ACCESSORIES OF 11KV XLPE COVERED CONDUCTOR</b>		
Document No.	ENG-ELC-071	Issue Date: 13.05.2022	
Revision No.	00	Page 8 of 18	
Prepared by: Jeevan Sangram	Reviewed By: Barsha Bandita	Approved By: Khajan C. Bhardwaj	Issued By: Pourush Garg

damage. The arching Horn Assembly protection device consists of:

- a) Two arcing horns with adjustable distance “L” directly mounted on the insulator terminals.
- b) A covered conductor with clamp on the horn side.
- c) An insulation piercing connector on the main cable side.

## 6. MARKING:

The following particulars shall be properly legible embossed/Printing on the accessories.

- a) Name & Trade mark of the manufacturer
- b) Product Code
- c) Batch Number
- d) The minimum and maximum cross section of Conductor for which the unit is suitable
- e) Month and Year of Manufacturer
- f) “TPCODL” Name

## 7. TESTS

A type test shall be performed on the accessories. All the Acceptance test, Type test and Routine test should be as per EN 50397-2 and latest amendment. The bidder shall be required to submit complete set of the following test reports along with the offer: -

### 7.1 ACCEPTANCE TESTS

#### i) Tension Assembly-Wedge Type (TA)

- a) Visual examination
- b) Dimension verification
- c) Tensile test at ambient temperature
- d) Check for permanent marking

#### ii) Non Metallic Alignment Ties

- a) Visual examination
- b) Dimension verification
- c) Check for permanent marking
- d) Failure Load Tests
- e) Slip Load Tests
- f) Lift / Side Load Tests

#### iii) Mechanical Connector With Heat Shrink Sleeve

- a) Visual examination

 TP CODL TP CENTRAL ODISHA DISTRIBUTION LIMITED	TP CENTRAL ODISHA DISTRIBUTION LIMITED, BHUBANESWAR		
	TECHNICAL SPECIFICATION		
Document Title	SPECIFICATION FOR ACCESSORIES OF 11KV XLPE COVERED CONDUCTOR		
Document No.	ENG-ELC-071	Issue Date: 13.05.2022	
Revision No.	00	Page 9 of 18	
Prepared by: Jeevan Sangram	Reviewed By: Barsha Bandita	Approved By: Khajan C. Bhardwaj	Issued By: Pourush Garg

- b) Dimension verification
- c) Check for permanent marking
- d) Mechanical Test
- e) Water Tightness test

**iv) Insulation Piercing Connector**

- a) Visual examination
- b) Dimension verification
- c) Check for permanent marking
- d) Mechanical Test

**v) Mid Span Joints**

- a) Visual examination
- b) Dimension verification
- c) Check for permanent marking
- d) Mechanical Test

**vi) Arc Protection Devices**

- a) Visual examination
- b) Dimension verification
- c) Check for permanent marking
- d) Clamp Bolt Tightening Test
- e) Short Circuit test

**7.2 ROUTINE TESTS**

**i) Tension Assembly-Wedge Type (TA)**

- a) Visual examination
- b) Dimension verification

**ii) Non Metallic Alignment Ties**

- a) Visual examination
- b) Dimension verification
- c) Check for permanent marking
- d) Failure Load Tests
- e) Slip Load Tests
- f) Lift / Side Load Tests

 TP CODL TP CENTRAL ODISHA DISTRIBUTION LIMITED	TP CENTRAL ODISHA DISTRIBUTION LIMITED, BHUBANESWAR		
	TECHNICAL SPECIFICATION		
Document Title	SPECIFICATION FOR ACCESSORIES OF 11KV XLPE COVERED CONDUCTOR		
Document No.	ENG-ELC-071	Issue Date: 13.05.2022	
Revision No.	00	Page 10 of 18	
Prepared by: Jeevan Sangram	Reviewed By: Barsha Bandita	Approved By: Khajan C. Bhardwaj	Issued By: Pourush Garg

### iii) Mechanical Connector With Heat Shrink Sleeve

- a) Visual examination
- b) Dimension verification
- c) Check for permanent marking
- d) Mechanical Test

### iv) Insulation Piercing Connector

- a) Visual examination
- b) Dimension verification
- c) Check for permanent marking
- d) Mechanical Test

### v) Mid Span Joints

- a) Visual examination
- b) Dimension verification
- c) Check for permanent marking
- d) Mechanical Test

### vi) Arc Protection Devices

- a) Visual examination
- b) Dimension verification
- c) Check for permanent marking
- d) Clamp Bolt Tightening Test

## 7.3 TYPE TESTS

### i) Tension Assembly-Wedge Type (TA)

- g) Visual examination
- h) Dimension verification
- i) Tensile test at ambient temperature
- j) Tensile test at low temperature
- k) Tensile test at high temperature
- l) Corrosion test
- m) Climate ageing test
- n) Check for permanent marking

 TP CODL TP CENTRAL ODISHA DISTRIBUTION LIMITED	TP CENTRAL ODISHA DISTRIBUTION LIMITED, BHUBANESWAR		
	TECHNICAL SPECIFICATION		
Document Title	SPECIFICATION FOR ACCESSORIES OF 11KV XLPE COVERED CONDUCTOR		
Document No.	ENG-ELC-071	Issue Date: 13.05.2022	
Revision No.	00	Page 11 of 18	
Prepared by: Jeevan Sangram	Reviewed By: Barsha Bandita	Approved By: Khajan C. Bhardwaj	Issued By: Pourush Garg

**ii) Non Metallic Alignment Ties**

- a) Visual examination
- b) Dimension verification
- c) Check for permanent marking
- d) Failure Load Tests
- e) Slip Load Tests
- f) Lift / Side Load Tests
- g) Thermal Tests under load
- h) Corrosion test
- i) Climate ageing test

**iii) Mechanical Connector With Heat Shrink Sleeve**

- a) Visual examination
- b) Dimension verification
- c) Check for permanent marking
- d) Mechanical Test
- e) Water Tightness test
- f) Climatic Ageing Test
- g) Corrosion Test
- h) Electrical Ageing Test

**iv) Insulation Piercing Connector**

- a) Visual examination
- b) Dimension verification
- c) Check for permanent marking
- d) Mechanical Test
- e) Water Tightness test
- f) Climatic Ageing Test
- g) Corrosion Test
- h) Electrical Ageing Test

**v) Mid Span Joints**

- a) Visual examination
- b) Dimension verification
- c) Check for permanent marking
- d) Mechanical Test
- e) Water Tightness test

 TP CODL TP CENTRAL ODISHA DISTRIBUTION LIMITED	TP CENTRAL ODISHA DISTRIBUTION LIMITED, BHUBANESWAR		
	TECHNICAL SPECIFICATION		
Document Title	<b>SPECIFICATION FOR ACCESSORIES OF 11KV XLPE COVERED CONDUCTOR</b>		
Document No.	ENG-ELC-071	Issue Date: 13.05.2022	
Revision No.	00	Page 12 of 18	
Prepared by: Jeevan Sangram	Reviewed By: Barsha Bandita	Approved By: Khajan C. Bhardwaj	Issued By: Pourush Garg

f) Climatic Ageing Test

g) Corrosion Test

**vi) Arc Protection Devices**

a) Visual examination

b) Dimension verification

c) Check for permanent marking

d) Clamp Bolt Tightening Test

e) Short Circuit test

**8. TYPE TEST CERTIFICATES:**

The Bidder shall furnish the type test certificates of the tests as mentioned above as per the corresponding standards. All the tests shall be conducted at **CPRI/ERDA or any government lab** as per the relevant IS/IEC. Type tests should have been conducted in certified Test laboratories during the period not exceeding 5 years from the date of opening the bid. In the event of any discrepancy in the test reports, i.e. any test report not acceptable, same shall be carried out without any cost implication to TPCODL.

**9. PRE DISPATCH INSPECTION:**

The material shall be subject to inspection by a duly authorized representative of the TPCODL. Inspection may be made at any stage of manufacture at the discretion of the purchaser and the equipment, if found unsatisfactory as to workmanship or material, the same is liable to rejection. Bidder shall grant free access to the places of manufacture to TPCODL's representatives at all times when the work is in progress. Inspection by the TPCODL or its authorized representatives shall not relieve the bidder of his obligation of furnishing equipment in accordance with the specifications. Material shall be dispatched after specific MDCC (Material Dispatch Clearance Certificate) is issued by TPCODL.

Following documents shall be sent along with material.

a) Test reports

b) MDCC issued by TPCODL

c) Invoice in duplicate

d) Packing list

e) Drawings & catalogue

f) Guarantee / Warrantee card

g) Delivery Challan

h) Other Documents (as applicable).



 TP CODL TP CENTRAL ODISHA DISTRIBUTION LIMITED	TP CENTRAL ODISHA DISTRIBUTION LIMITED, BHUBANESWAR		
	TECHNICAL SPECIFICATION		
Document Title	SPECIFICATION FOR ACCESSORIES OF 11KV XLPE COVERED CONDUCTOR		
Document No.	ENG-ELC-071	Issue Date: 13.05.2022	
Revision No.	00	Page 13 of 18	
Prepared by: Jeevan Sangram	Reviewed By: Barsha Bandita	Approved By: Khajan C. Bhardwaj	Issued By: Pourush Garg

#### 10. INSPECTION AFTER RECEIPT AT STORES:

The material received at TPCODL, Odisha store will be inspected for acceptance and shall be liable for rejection, if found different from the reports of the pre-dispatch inspection and one copy of the report shall be sent to Engineering department.

#### 11. GUARANTEE:

Bidder shall stand guarantee towards design, materials, workmanship & quality of process/ manufacturing of items under the contract for due and intended performance of the same, as an integrated product delivered under this contract. In the event any defect is found by the Company up to a period of 24 months from the date of commissioning or 30 months from the date of last supplies made under the contract, whichever is earlier, supplier shall be liable to undertake to replace/rectify such defects at his own costs. within mutually agreed timeframe, and to the entire satisfaction of the Company, failing which the Company will be at liberty to get it replaced/rectified at supplier's risks and costs and recover all such expenses plus the Company's own charges (@ 20% of expenses incurred), from the supplier or from the "Security cum Performance Deposit" as the case may be.

The bidder shall further be responsible for 'free replacement' for another period of THREE years from the end of guarantee period for any 'latent defects' if noticed by the company.

#### 12. PACKING:

Supplier shall ensure that all the equipment covered under this specification shall be prepared for rail/road transport and be packed in such a manner so as to protect the equipment from damage in transit. The material used for packing shall be environmentally friendly. The bidder shall provide instructions regarding handling and storage precautions to be taken at site.

#### 13. TENDER SAMPLE:

Bidder shall submit the sample of material during submission of Bids.

#### 14. QUALITY CONTROL:

The bidder shall submit with the offer Quality Assurance Plan indicating the various stages of inspection, the tests and checks which will be carried out on the material of construction, components during manufacture and bought out items and fully assembled component and equipment after finishing. As part of the plan, a schedule for stage and final inspection within the parameters of the delivery schedule shall be furnished. The Purchaser's engineer or its nominated representative shall have free access to the manufacturer's/sub-supplier's works to carry out inspections. The bidder shall ensure that the material supplied is as per the Guaranteed Technical Particulars as specified in the specifications.

 TP CODL TP CENTRAL ODISHA DISTRIBUTION LIMITED	TP CENTRAL ODISHA DISTRIBUTION LIMITED, BHUBANESWAR		
	TECHNICAL SPECIFICATION		
Document Title	<b>SPECIFICATION FOR ACCESSORIES OF 11KV XLPE COVERED CONDUCTOR</b>		
Document No.	ENG-ELC-071	Issue Date: 13.05.2022	
Revision No.	00	Page 14 of 18	
Prepared by: Jeevan Sangram	Reviewed By: Barsha Bandita	Approved By: Khajan C. Bhardwaj	Issued By: Pourush Garg

## 15. TESTING FACILITIES:

Bidder shall have adequate in-house testing facilities for carrying out all routine tests & acceptance tests as per relevant International / Indian standards.

## 16. MANUFACTURING ACTIVITIES:

The successful bidder will have to submit the bar chart for various manufacturing activities clearly elaborating each stage, with quantity. This bar chart should be in line with the Quality assurance plan submitted with the offer.

## 17. SPARES, ACCESSORIES AND TOOLS

Not applicable.

## 18. DRAWINGS AND DOCUMENTS

Following drawings and documents shall be submitted in line with the requirement of Tender specifications:

- Completely filled in Schedule "A" Guaranteed Technical Particulars & Schedule "B" Deviations
- Work Experience details
- Type test certificates.
- Drawing 1 set of Hard Copy & Soft copy PDF File containing complete information about manufacturing.

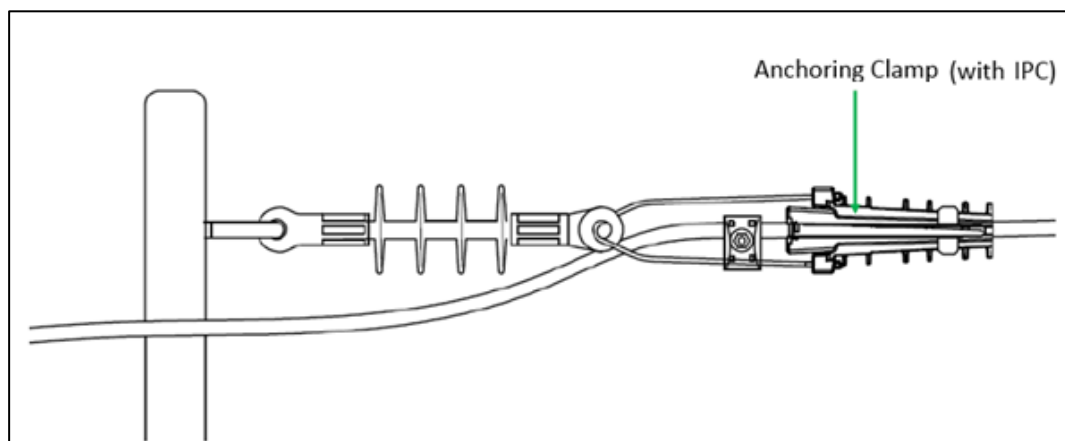



Fig.1:- Tension Assembly (TA) with Anchoring clamp and one Tracking protection IPC

 TP CODL TP CENTRAL ODISHA DISTRIBUTION LIMITED	TP CENTRAL ODISHA DISTRIBUTION LIMITED, BHUBANESWAR		
	TECHNICAL SPECIFICATION		
Document Title	<b>SPECIFICATION FOR ACCESSORIES OF 11KV XLPE COVERED CONDUCTOR</b>		
Document No.	ENG-ELC-071	Issue Date: 13.05.2022	
Revision No.	00	Page 15 of 18	
Prepared by: Jeevan Sangram	Reviewed By: Barsha Bandita	Approved By: Khajan C. Bhardwaj	Issued By: Pourush Garg

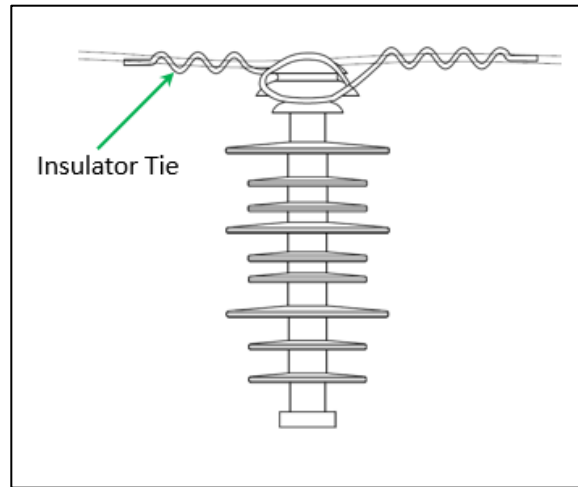

Fig.2:- Non Metallic Alignment Tie

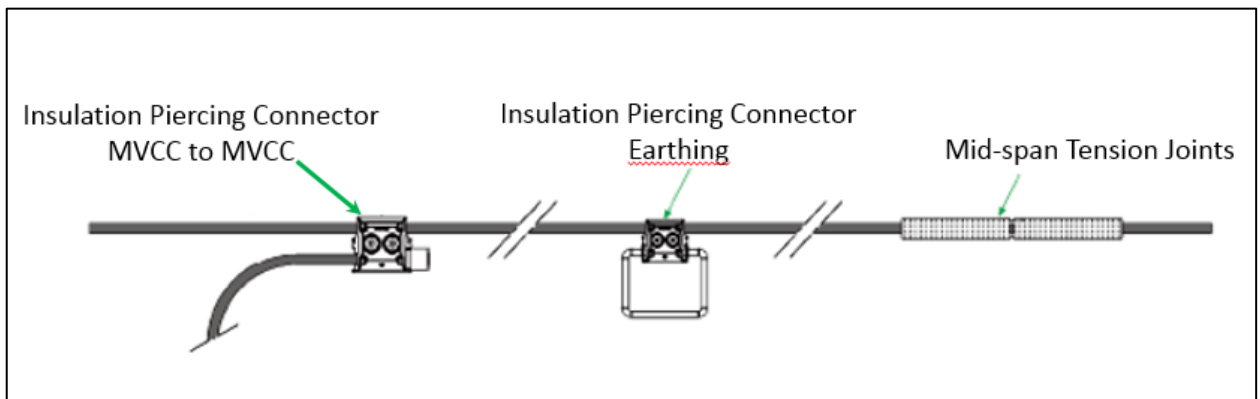

Fig.3:- Insulation Piercing Connector for Networking / Branching / Looping and Midspan Joints

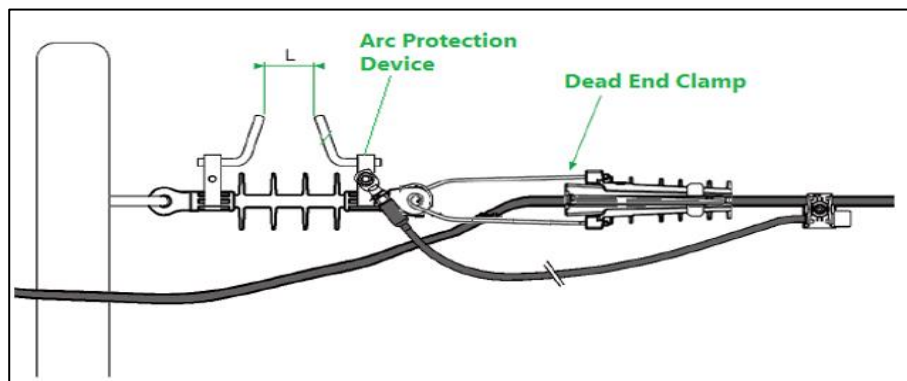



Fig.4:- Arc Protection Device

Note:- These are the Sample Drawing for tender purpose only.

 TP CODL TP CENTRAL ODISHA DISTRIBUTION LIMITED	TP CENTRAL ODISHA DISTRIBUTION LIMITED, BHUBANESWAR		
	TECHNICAL SPECIFICATION		
Document Title	SPECIFICATION FOR ACCESSORIES OF 11KV XLPE COVERED CONDUCTOR		
Document No.	ENG-ELC-071	Issue Date: 13.05.2022	
Revision No.	00	Page 16 of 18	
Prepared by: Jeevan Sangram	Reviewed By: Barsha Bandita	Approved By: Khajan C. Bhardwaj	Issued By: Pourush Garg

## 19. SCHEDULE- "A" GUARANTEED TECHNICAL PARTICULARS

### TENSION ASSEMBLY-WEDGE TYPE (TA)

Sl. No.	Technical Parameters	To Be Furnished By The Bidder
1	Name of the manufacturer	
2	Applicable Standard	
3	Range of Conductor size	
4	Installation(with/without disassembly)	
5	Type & grade	
6	Application	
7	Mechanical Strength	
8	Dimensions (mm)	

### NON METALLIC ALIGNMENT TIES

Sl. No.	Technical Parameters	To Be Furnished By The Bidder
1	Name of the manufacturer	
2	Applicable Standard	
3	Range of Conductor size	
4	Mounting	
5	Type	
6	Material	
7	Application	
8	Dimensions (mm)	

### MECHANICAL CONNECTOR WITH HEAT SHRINK SLEEVE

Sl. No.	Technical Parameters	To Be Furnished By The Bidder
1	Name of the manufacturer	
2	Applicable Standard	
3	Range of Conductor size	
4	Installation	
5	Type of connection required	
6	Is any metallic part carrying potential in operation exposed during installation	

 TP CODL TP CENTRAL ODISHA DISTRIBUTION LIMITED	TP CENTRAL ODISHA DISTRIBUTION LIMITED, BHUBANESWAR		
	<b>TECHNICAL SPECIFICATION</b>		
<b>Document Title</b>	<b>SPECIFICATION FOR ACCESSORIES OF 11KV XLPE COVERED CONDUCTOR</b>		
<b>Document No.</b>	ENG-ELC-071	<b>Issue Date: 13.05.2022</b>	
<b>Revision No.</b>	00	<b>Page 17 of 18</b>	
<b>Prepared by:</b> Jeevan Sangram	<b>Reviewed By:</b> Barsha Bandita	<b>Approved By:</b> Khajan C. Bhardwaj	<b>Issued By:</b> Pourush Garg

Sl. No.	Technical Parameters	To Be Furnished By The Bidder
7	Material	
8	Connector ID	

### INSULATION PIERCING CONNECTOR

Sl. No.	Technical Parameters	To Be Furnished By The Bidder
1	Name of the manufacturer	
2	Applicable Standard	
3	Range of Conductor sizes accommodated for Main & Branch	
4	Application	
5	Type of connection required	
6	Is any metallic part carrying potential in operation exposed during installation	
7	Are end caps of branch cable a) Slide on type (b) Rigid	
8	Are torque limiting shear heads provided to tightening bolts	
9	Specified Torque	
10	Torque for establishing connection between main and Tap (Nm)	

### MID SPAN JOINTS

Sl. No.	Technical Parameters	To Be Furnished By The Bidder
1	Name of the manufacturer	
2	Applicable Standard	
3	Type No & Size Range	
4	Application	
5	Type of connection required	
6	Is any metallic part carrying potential in operation exposed during installation	
7	Installation	

 <b>TPCODL</b> TP CENTRAL ODISHA DISTRIBUTION LIMITED	TP CENTRAL ODISHA DISTRIBUTION LIMITED, BHUBANESWAR		
	<b>TECHNICAL SPECIFICATION</b>		
<b>Document Title</b>	<b>SPECIFICATION FOR ACCESSORIES OF 11KV XLPE COVERED CONDUCTOR</b>		
<b>Document No.</b>	ENG-ELC-071	<b>Issue Date: 13.05.2022</b>	
<b>Revision No.</b>	00	<b>Page 18 of 18</b>	
<b>Prepared by:</b> Jeevan Sangram	<b>Reviewed By:</b> Barsha Bandita	<b>Approved By:</b> Khajan C. Bhardwaj	<b>Issued By:</b> Pourush Garg

## 20. SCHEDULE "B" DEVIATIONS:

### **(TO BE ENCLOSED WITH TECHNICAL BID)**

All deviations from this specification shall be set out by the Bidders, clause by Clause in this schedule. Unless specifically mentioned in this Schedule, the tender shall be deemed to confirm the purchaser's specifications:

SL. No	Clause No.	Details of deviation with justifications

We confirm that there are no deviations apart from those detailed above.

Seal of the Company:

Signature

Designation

<b>TPCODL</b>	<b>TP CENTRAL ODISHA DISTRIBUTION LIMITED</b>	
	<b>WORK INSTRUCTION /OPERATING GUIDELINES</b>	
Doc. Title	<b>GENERAL CONDITIONS OF CONTRACT- COMPOSITE ORDERS</b>	
Rev. No	0	Page 1 of 104

<b>CONTENTS</b>	
<b>CLAUSE NO.</b>	<b>DESCRIPTION</b>
<b>1.0</b>	<b>ORGANIZATIONAL VALUES</b>
<b>2.0</b>	<b>ETHICS</b>
<b>3.0</b>	<b>CONTRACT PARAMETERS</b>
3.1	Issue/ Award of Contract
3.2	Contract Commencement Date
3.3	Contract Completion Date
3.4	Contract Period/Time
3.5	Contract Execution Completion Date
3.6	Contract Execution Period/Time
3.7	Contract Price /Value
3.8	Contract Document
3.9	Contract Language
3.10	Reverse Auction
<b>4.0</b>	<b>SCOPE OF WORK</b>
4.1	Technical Evaluation
4.2	Indemnity
4.3	Display of notice boards at work site
4.4	Disposal of waste at site
4.5	Deployment of workforce
4.6	Damage of Properties
4.7	Issuance of material
4.8	Company's right to use works
4.9	Rights of TPCODL to vary the scope work
<b>5.0</b>	<b>PRICES/RATES/TAXES</b>
5.1	For Supply part of Contract
5.2	For Service part of Contract
5.3	Changes in statutory Tax Structure

Doc. Title	<b>GENERAL CONDITIONS OF CONTRACT - COMPOSITE WORKS</b>	
Rev. No	0	Page 2 of 104

<b>CONTENTS</b>	
<b>CLAUSE NO.</b>	<b>DESCRIPTION</b>
<b>6.0</b>	<b>TERMS OF PAYMENT</b>
6.1	Pre-Requisites for Payment
6.2	Bills & Invoices
6.3	Payment & Statutory Deductions
6.4	Guidelines for Raising Running/Final Bills
6.5	Quantity Variation
6.6	Full and Final Payment
<b>7.0</b>	<b>MODE OF PAYMENT</b>
<b>8.0</b>	<b>SECURITY CUM PERFORMANCE DEPOSIT</b>
<b>9.0</b>	<b>STATUTORY COMPLIANCE</b>
9.1	Compliance to Various Acts
9.2	SA 8000
9.3	Affirmative Action
9.4	Compliance to Labour Laws
9.5	Compliance to C&D Waste Management Rules & Environment (Protection) Amendment Rules
<b>10.0</b>	<b>QUALITY</b>
10.1	Knowledge of Requirements
10.2	Material/Equipment/Works Quality
10.3	Adherence to Rules & Regulations
10.4	Specifications and Standards
<b>11.0</b>	<b>SAFETY</b>
<b>12.0</b>	<b>INSPECTION/PARTICIPATION</b>
12.1	Right to Carry Out Inspection
12.2	Facilitating Inspection
12.3	Third Party Nomination
12.4	Waiver of Inspections
12.5	Incorrect Inspection Call
<b>13.0</b>	<b>MDCC &amp; DELIVERY OF MATERIALS</b>
13.1	Material Dispatch Clearance Certificate



Doc. Title	<b>GENERAL CONDITIONS OF CONTRACT - COMPOSITE WORKS</b>	
Rev. No	0	Page 3 of 104

<b>CONTENTS</b>	
<b>CLAUSE NO.</b>	<b>DESCRIPTION</b>
13.2	Right to Rejection on Receipt
13.3	Consignee
13.4	Submission of Mandatory Documents on delivery
13.5	Dispatch and Delivery Instructions
<b>14.0</b>	<b>GUARANTEE</b>
14.1	Guarantee of Performance
14.2	Guarantee period
14.3	Failure in Guarantee period (GP)
14.4	Cost of repairs on failure in GP
14.5	Guarantee Period for Goods Outsourced
14.6	Latent Defect
14.7	Support beyond the Guarantee Period
<b>15.0</b>	<b>LIQUIDATED DAMAGES</b>
15.1	LD Waiver Request
15.2	Material Recovery
<b>16.0</b>	<b>ASSIGNMENT OR SUBCONTRACTING</b>
<b>17.0</b>	<b>UNLAWFUL ACTIVITIES</b>
<b>18.0</b>	<b>CONFIDENTIALITY</b>
18.1	Documents
18.2	Geographical Data
18.3	Associate's Processes
18.4	Exclusions
18.5	Violation
<b>19</b>	<b>INTELLECTUAL PROPERTY RIGHTS</b>
<b>20</b>	<b>INDEMNITY</b>
<b>21</b>	<b>LIABILITY &amp; LIMITATIONS</b>
21.1	Liability
21.2	Limitation of Liability
<b>22.0</b>	<b>FORCE MAJEURE</b>

Doc. Title	<b>GENERAL CONDITIONS OF CONTRACT - COMPOSITE WORKS</b>	
Rev. No	0	Page 4 of 104

<b>CONTENTS</b>	
<b>CLAUSE NO.</b>	<b>DESCRIPTION</b>
<b>23.0</b>	<b>SUSPENSION OF CONTRACT</b>
23.1	Suspension for Convenience
23.2	Suspension for Breach of Contract Conditions
23.3	Compensation in lieu of Suspension
<b>24.0</b>	<b>TERMINATION OF CONTRACTS</b>
24.1	Termination for default/breach of contract
24.2	Termination for convenience of associate
24.3	Termination for Convenience of TPCODL
<b>25.0</b>	<b>Dispute resolution and Arbitration</b>
25.1	Governing laws and jurisdiction
<b>26.0</b>	<b>ATTRIBUTES OF GCC</b>
26.1	Cancellation
26.2	Severability
26.3	Order of Priority
<b>27.0</b>	<b>INSURANCE</b>
<b>28.0</b>	<b>ERRORS AND OMISSIONS</b>
<b>29.0</b>	<b>TRANSFER OF TITLES</b>
<b>30.0</b>	<b>SUGGESTIONS &amp; FEEDBACK</b>
<b>31.0</b>	<b>CONTACT POINTS</b>
<b>32.0</b>	<b>LIST OF ANNEXURES</b>

Doc. Title	GENERAL CONDITIONS OF CONTRACT - COMPOSITE WORKS	
Rev. No	0	Page 5 of 104

## 1.0 ORGANIZATIONAL VALUES

The Tata Group has always been a value driven organization. These values continue to direct the Group's growth and businesses. The Six core Tata Values underpinning the way we do business are:

**Integrity** - We must conduct our business fairly, with honesty and transparency. Everything we do must stand the test of public scrutiny.

**Understanding** - We must be caring, respectful, compassionate and humanitarian towards our colleagues and customers around the world and always work for the benefit of India.

**Excellence** - We must constantly strive to achieve the highest possible standards in our day to day work and in the quality of goods and services we provide.

**Unity** - We must work cohesively with our colleagues across the group and with our customers and partners around the world to build strong relationships based on tolerance, understanding and mutual co-operation.

**Responsibility** - We must continue to be responsible and sensitive to the countries, communities and environments in which we work, always ensuring that what comes from the people goes back to the people many times over.

**Agility** - We must work in a speedy and responsive manner and be proactive and innovative in our approach.

## 2.0 ETHICS

In our effort towards Excellence and in Management of Business Ethics at TPCODL, an Ethics Management Team is constituted.

The main objective of the Ethics Management Team is to:

1. Record, address and allay the issues and concerns on ethics raised by different stakeholders like employees, consumers, vendors, Associates etc. by initiating immediate corrective actions.
2. Ensure proper communication of the ethics policies and guidelines through prominent displays at all offices of TPCODL and through printed declarations in all concerned documents where external stakeholders are involved.
3. Ensure proper framework of policies as preventive measures against any ethics violation recorded by them.
4. Prepare and submit MIS of all issues and concerns, corrective and preventive actions on monthly basis to the top management for their information.

All members of Team TPCODL, Associates and Stakeholders are requested to register any grievance on ethics violation on Central Control Telephone No. 011-66404040.

## 3.0 CONTRACT PARAMETERS

### 3.1 Issue/Award of Contract

TPCODL awards the contract to the Associate in writing in the form of Purchase order or Rate Contract (RC) hereafter referred as Contract, through in any or all of following modes- physical handover / post / e-mail / web document / fax with all the attachments/enclosures which shall be part of the contract document

Doc. Title	GENERAL CONDITIONS OF CONTRACT - COMPOSITE WORKS	
Rev. No	0	Page 6 of 104

On receipt of the contract, the associate shall return to TPCODL copy of the contract document duly signed by legally authorized representative of associate, within two days of Effective Date of Contract for contracts having contract execution time less than 30 days and within five days for all other contracts.

### **3.2 Contract Commencement Date**

The date of issue/award of contract shall be the Effective Date of Contract or Contract Commencement date.

### **3.3 Contract Completion Date**

The date of expiry of Guarantee Period (detailed in section 12 of this document) shall be deemed as the Contract Completion Date.

### **3.4 Contract Period/Time**

The period from Contract Commencement Date to Contract Completion Date shall be deemed as the Contract Period/Time.

### **3.5 Contract Execution Completion Date**

The stipulated date for completing the execution of all items in the schedule of quantities (Supply, Service and or both as applicable) shall be deemed as the Contract Execution Completion Date.

### **3.6 Contract Execution Period/Time**

The Period from Contract Commencement Date to Contract Execution Completion Date shall be the Contract Execution Period/Time. Timely Completion of Works/Timely Delivery of Materials is the essence of the contract. The period from effective date of contract to the date stipulated for completion of delivery of all items/completion of all the works/services, as per schedule of quantities of the contract is defined as contract execution completion time. The Delivery of Materials /The Completion of Works, as applicable, should be achieved in all respects as per schedules of quantities and all the terms and conditions of the contract, in the contract execution time.

Any revision/amendment in the originally stipulated contract execution time has to be approved by authorized representative of TPCODL.

### **3.7 Contract Price /Value**

The total all inclusive price/value mentioned in the LOI/PO/RC of the contract document is the Contract Price/Value and is based on the quantity, unit rates and prices quoted and awarded and shall be subject to adjustment based on actual quantities supplied/actual measurement of work done and accepted and certified by the authorized representative of the company unless otherwise specified in schedule of quantities or in contract documents.

### **3.8 Contract Document**

The Contract Document shall mean and include but not limited to the following:

- NIT/Tender Enquiry, QR, Instruction to Bidders, Special Condition of Contract (SCC) of tender, GCC, Technical & Commercial Specifications including relevant annexure and attachments).
- Bids & Proposals Received from Associate including relevant annexure/attachments.

Doc. Title	GENERAL CONDITIONS OF CONTRACT - COMPOSITE WORKS	
Rev. No	0	Page 7 of 104

- Letter of Intent (LOI/RC/PO) with agreed deviations from the tender/bid documents.
- All the Inspection and Test reports, Detailed Engineering Drawings.
- Material Dispatch Clearance Certificate (MDCC).
- Minutes of Meeting (MoM)

### 3.9 Contract Language

All documents, instructions, catalogues, brochures, pamphlets, design data, norms and calculations, drawings, operation, maintenance and safety manuals, reports, labels, on deliveries and any other data shall be in English Language.

The Contract documents and all correspondence between the TPCODL, Third Parties associated with the contract, and the Associate shall be in English language.

However, all signboards required indicating "Danger" and/or security at site and otherwise statutory required shall be in English, Hindi, and local languages.

### 3.10 Reverse Auction

TPCODL reserves the right to conduct the reverse auction (instead of public opening of price bids) for the products / services being asked for in the tender. The terms and conditions for such reverse auction events shall be as per the Acceptance Form attached in Annexure J. The bidders along with the tender document shall mandatorily submit a duly signed copy of the Acceptance Form as mentioned in the Annexure J as a token of acceptance for the same.

### 4.0 SCOPE OF WORK

All the activities that are to be undertaken by the Associate to realize the contractual deliverables in completeness form Scope of Work. Following clauses list, but not limited to, major requirements of the scope of work.

The associate shall satisfy himself and undertake fully the technical/commercial requirements of items to be supplied as listed in the Schedule of Quantities together with the tests to be performed /test reports to be furnished before dispatch, arrangement of stage and final inspections during manufacturing as per terms and conditions of contract, technical parameters & delivery terms and conditions including transit insurance to be met in order to fully meet TPCODL's requirements.

Completeness: Any supplies and services which might have not been specifically mentioned in the Contract but are necessary for the scope mentioned in Special Terms & Conditions and/or completeness of the works at the highest possible level, including any royalties, licence fees & compensation to be paid, whether incurred by the associates or by a third party for the work covered in the scope, regardless of when incurred, shall be supplied/provided by the associate without any extra cost and within the time schedule for efficient , smooth and satisfactory operation and maintenance of the works at the highest possible level under Indian conditions (but according to international standards for facility of this type), unless expressly excluded from the scope of supplies and services in this Contract.

TPCODL have the right, during the performance of the Contract, to change the scope and/or technical character of the Project and/or of the supplies and services stipulated in the

Doc. Title	GENERAL CONDITIONS OF CONTRACT - COMPOSITE WORKS	
Rev. No	0	Page 8 of 104

Contract by submitting a request in writing to the Associate. The Associate shall, within fifteen days of receipt of such request from the TPCODL, provide Purchaser with a reasonably detailed estimate of the cost of the change outlined in the request.

In the event, TPCODL requests a change, the Contract price and time shall be adjusted upwards or downwards, as the case may be and shall be mutually agreed to. The associate shall not be entitled to any extension of time unless such changes adversely affect the time schedule.

The Associate shall not proceed with the changes as requested till adjustment of contract price and time schedule where so applicable in terms of or otherwise directed by the TPCODL.

#### 4.1 Technical Evaluation

TPCODL reserves the right to assign scores to different parameters including but not limited to the following while evaluating the bids. TPCODL reserves the right to change the parameters and score without prior information to the associates:

S. No.	Evaluation Parameter	Max. Score
<b>A</b>	<b>Bidders already Registered with TPCODL</b>	<b>100</b>
<b>A.1.</b>	<b>Quality of the Products &amp; Services</b>	
	a. <u>For Supply Part:</u> No Material Rejections in last 2 years Deduction of 3 marks for each PO/ RO (for same product category) with major rejections in last 2 years. (Major rejection shall be considered when material is taken back by the vendor for rectification and the quantity of rejected material is more than 10%).	12
	b. <u>For Service Part:</u> No violation of statutory compliances in last 1 year. Deduction of 2 marks for each instance of violation in last 1 year.	12
	c. <u>Safety</u> Deduction of 2 marks for each instance of safety violation in last 1 year. Deduction of 4 marks for each reported Non-Fatal Accident in last 1 year. In case of any reported fatal accident: <b>ZERO MARKS</b>	16
<b>A.2.</b>	<b>Timely Execution of Contracts</b> Total Achieved Score = {30 – 3 x (Avg. %age LD deductions in last 2 years)}	30
<b>A.3.</b>	<b>Legal Issues with TPCODL</b> Zero instances of Arbitration procedures / Court Cases / PBG forfeitures in last 2 years: 30 marks else 'Zero' marks	30
<b>B</b>	<b>Bidders new to TPCODL</b>	<b>100</b>
<b>B.1.</b>	<b>Visits</b> <u>For Supply Part:</u> Factory Visit and Evaluation. <u>For Service Part:</u> Client Site Visit where the bidder is providing similar services.	30
	The visits as above shall be arranged by the bidder. However all costs towards conveyance, lodging, boarding etc. shall be borne by TPCODL. The score assigned by TPCODL based on the above visits shall be final and binding on the bidder. <b>Safety:</b>	20

Doc. Title	GENERAL CONDITIONS OF CONTRACT - COMPOSITE WORKS	
Rev. No	0	Page 9 of 104

S. No.	Evaluation Parameter	Max. Score
	Score achieved against the BA safety Management System questionnaire.	
<b>B.2.</b>	<p><b>Client Referrals</b> At least 3 nos. Customer References for similar products/ services in last 3 years. All customer references shall be either of the following:</p> <ul style="list-style-type: none"> <li>▪ Govt. Organizations/ PSUs/ Power Distribution Utilities.</li> <li>▪ Private Organizations with an annual turnover of <math>\geq</math> 500 cr.</li> </ul> <p>PO copies or Completion Certificates are admissible. Each reference: 10 marks</p>	30
<b>B.3.</b>	<p><b>Blacklisting Information</b> Not blacklisted by any reputed organization / utility in last 2 years: 20 marks else 'Zero' marks.</p>	20

- Bidder shall be considered as technically qualified if they are able to achieve a technical score of  $>70$  marks on the above parameters. 'A' or 'B'.
- The bidder must have the PF and ESI registration. In case it is not there (provided the bidder is not exempted from the PF and ESI), bidder shall not be evaluated on the above parameters and will be considered as disqualified.

#### 4.2 Indemnity

Associates shall undertake to fully indemnify TPCODL (also referred to as the Company in the GCC) against all kinds of liabilities or damages, of whatsoever nature, including compensation arising from any accident to the person or property of those in Associate's employment or to any other person or properties including those of TPCODL, arising due to reasons attributable to any, act, omission or negligence of the Associate the Associates, for the entire period of contract including period of guarantee.

Within 7 days of award of work, the Associates shall submit Indemnity Bond in the format as per Annexure-E to Order Issuing Authority.

Contract having value more than Rs 2 Cr per Annum, Associates shall submit Indemnity Bond on Rs 100/- Non Judicial Stamp Paper in the format as per Annexure- E to Order Issuing Authority.

#### 4.3 Display of Notice Boards at Work Sites

The Associate shall put up display notice board at each project site where the works are in progress indicating the information given below:

- Name of the Project.
- Estimated Cost of Project.
- Date of Commencement.
- Expected date of completion.
- Name of Associate and his telephone number.
- Name of Engineer-in-Charge and his telephone number.

#### 4.4 Disposal of Waste at Site

Significant quantities of waste are generated during the execution of project and an integrated approach for effective handling, storage, transportation and disposal of the same shall be adopted. This would ensure the minimization of environmental and social impact in order to combat the climate change.

Doc. Title	GENERAL CONDITIONS OF CONTRACT - COMPOSITE WORKS	
Rev. No	0	Page 10 of 104

The associates shall follow the below criteria for disposal of waste at site during the execution of project.

- Associate shall ensure that the detailed project plan include the waste management, segregation of all designated waste material (Recyclable/ Non-Recyclable), collecting, storing, disposing and transferring the same to pre-arranged facility/destination in timely and safe manner as per environmental legislations during the execution of project. The project plan shall also include the innovative construction practice to eliminate or minimize waste, protect surface/ground water, control dust and other emissions to air and control noise during the execution of project. The copy of same shall be given to EIC before the commencement of project.
- The purchase policy of BA shall encourage the procurement of material with recycled and minimum packaging of goods during delivery. Associate shall provide the appropriate means for site to site transportation of materials to avoid damage and litter generation.
- Associate shall educate and inform to its project team about the requirement and responsibilities for waste minimization and disposal in general and provide training of practices that support this. Waste management should be treated like a safety program.
- In the event that area of contaminated or biological hazard is identified, Associate shall ensure that plant, equipment, personnel and any activity associated with the work is carried out in consultation with EIC of TPCODL.
- Associate shall ensure that the residents living near the site are kept informed about proposed working schedule and shall informed timings and duration of any abnormal noise full activity that is likely to happen.
- Associate shall ensure the regular maintenance and monitoring of vehicles and equipment for efficient fuel use so that emissions and noise are within acceptable limits to avoid air pollution.

#### **4.5 Deployment of Work Force**

Associate shall deploy adequate labour, as considered necessary by TPCODL for execution of the contract including Sundays and Holidays whenever required to do so with no extra cost to TPCODL. However, prior permission shall be taken from the site Engineer to carry out the work beyond normal working hours or on Sundays and Holidays. Female employees shall not be deployed beyond normal working hours/days and no child labour shall ever be deployed. Associate shall depute full time qualified and experienced engineers to supervise the work at site. All such staff shall be maintained from commencement to completion of all works to the entire satisfaction of the Engineer-in-Charge. Associate's employees deployed for the works under this contract will not be considered in Company's employment at any time. Associate shall continue to be responsible for all such employees, their safety, all types of statutory compliances related thereto and in any other manner whatsoever. The company will stand indemnified by the Associate in respect of all the above. At the same time Company upon noticing any breach or default on any statutory compliances, may at their sole discretion, decide to act in a manner as deemed fit at the risks and costs of the Associate.



Doc. Title	<b>GENERAL CONDITIONS OF CONTRACT - COMPOSITE WORKS</b>	
Rev. No	0	Page 11 of 104

TPCODL shall have the right to instruct the Associate to change the Sub- Associates or skilled /unskilled workers in case the conduct, the workmanship or speed of the work is not satisfactory.

Associates shall submit duly signed undertaking regarding engagement of competent staff / employee commensurate to the nature of job to Engineer–in–charge in the format attached as Annexure – H.

#### **4.6 Damages to Properties**

The Associates shall take necessary steps to ensure that the equipment and installations of the Company, Third parties, including other utility services like water supply pipelines; open drains telephone cables etc. are not damaged during execution of the works. The Associates shall be responsible for all such damages and shall have to repair/ replace and/or compensate for the entire claims in respect of such damages at its own cost.

#### **4.7 Issuance of Material**

The material issued to the Associate shall be in the custody of the Associates who shall be fully responsible for the same. After completion of the works, the Associates will reconcile the material. Any cost of material which is short or damaged/lost will be deducted from Associate bill/ deposits.

#### **4.8 Company's Right To Use Works**

If Taking Over Certificate is delayed for any reason, for which TPCODL's decision shall be final and binding upon the Associate, the Company shall be entitled to use the works or portion thereof without affecting Associate's responsibility and liability to complete the balance works as per company's directives from time to time, though Associate shall be afforded reasonable opportunity by the company to enable Associates to complete all balance works required for issuance of 'Taking Over Certificate' by the company.

#### **4.9 Rights of TPCODL to vary the scope work**

TPCODL shall have the right, during the performance of the Contract, to change the scope and/or technical character of the Project and/or of the supplies and services stipulated in the Contract by communicating the intent to do so in writing to the Associate. On receipt of such communication the Associate shall, within the time frame specified in the contract shall provide TPCODL with a reasonably detailed estimate of the cost of the change in scope outlined in the TPCODL communication. The change in the Contract price and time shall be revised upwards or downwards, as the case may be, and shall be mutually agreed to. The Associate shall not be entitled to any extension of time unless such changes adversely affect the time schedule.

The Associate shall not proceed with the changes in the scope of work till such time revision of Contract price and time schedule are approved and communicated to the associate by TPCODL.

Any change in the Scope of Work and/or Terms & Conditions of the order shall be intimated by TPCODL through an amendment to the contract. The amendment shall be treated valid only if signed by the authorized signatory of the original contract.

### **5.0 PRICES/ RATES/ TAXES**

#### **5.1 For Supply part of Contract**

Doc. Title	<b>GENERAL CONDITIONS OF CONTRACT - COMPOSITE WORKS</b>	
Rev. No	0	Page 12 of 104

Unless specified elsewhere in the contract document, the prices/rates are inclusive of cost of finished product for which MDCC will be issued by TPCODL, packaging and forwarding charges, freight and transit insurance charges covering loading at Associate's works, transportation to TPCODL store/site & unloading & delivery at TPCODL stores/TPCODL site, cost of documentation including all the relevant test certificates and other supportive documents to be furnished.

The Prices/Rates are inclusive of all taxes, levies, cesses and duties, particularly Goods and Services Tax as applicable. All government levy / taxes shall be paid only when the invoice is submitted according to the relevant act.

The prices/rates shall remain firm till actual completion of entire supply of goods/material/equipment as per contract is achieved and shall remain valid till the completion of the contract.

The prices shall remain unchanged irrespective of TPCODL making changes in quantum in all or any of the schedules of items of contract.

## **5.2 For Service part of Contract**

The Prices and Rates are inclusive of cost of materials supplied as per contract terms and for which MDCC is issued by TPCODL and to the extent required for completion of works, cost of service executed as per schedule of quantities, cost of testing as per contract terms, cost of documentations including all relevant test certificates and other supportive documents to be furnished as per contract terms. The rates shall remain firm till actual completion of contract.

The Prices/Rates are inclusive of all taxes, levies, cesses and duties, particularly Goods and Services Tax as applicable. All government levy / taxes shall be paid only when the invoice is submitted according to the relevant act.

The prices shall remain unchanged irrespective of TPCODL making changes in quantum in all or any of the schedules of items of contract.

## **5.3 Changes in Statutory Tax Structure**

If rate of any or all of the statutory taxes and duties applicable to the contract changes, such changes shall be incorporated by default if the changes occur within the contract execution time and shall be applicable if the contract is executed by the Associate within the Contract Execution Time.

For execution of contracts beyond contract execution time, where the delay is not attributable to TPCODL no upward revision in tax /duties shall be considered irrespective of changes in the statutory tax structure either within the contract execution time or beyond. However, in such cases, benefits due to any downward revisions in statutory tax rates shall be passed on to TPCODL.

## **6.0 TERMS OF PAYMENT**

- A. 5% of the Release Order/ Purchase Order price shall be paid as initial interest free advance on fulfillment of the following by the Associate:
  - a) Acceptance of PO/ LOI.
  - b) Submission of advance payment BG of 15% of the Release Order/ Purchase Order price which shall remain valid till the advance is fully adjusted.

Doc. Title	GENERAL CONDITIONS OF CONTRACT - COMPOSITE WORKS	
Rev. No	0	Page 13 of 104

- c) Submission of Contract Performance Bank Guarantee of 5/10% of the RC/ PO price valid till 30 days after taking over of the works.
- B. 10% of the Release Order/ Purchase Order price shall be paid as interest free advance against approval of drawings under Category-1 of major drawings, Quality Plans, Pert Chart, Field Quality Plan, posting of Project Manager and commencement of the first mile stone of the work mutually agreed including C-3 Form, and submission of a true copy of 'Erection All Risk Insurance Policy' taken for the awarded jobs. The drawing list shall be mutually agreed at the time of award of work.
- C. 50% on account payment of the total of item wise cost of material Release Order/ Purchase Order shall be paid against receipt of material at site in good condition and certification by TPCODL along with bills complete in all respects viz. MDCCs etc.
- D. 20% on account payment of the actual executed value shall be paid against mechanical completion of erection on prorata basis against monthly bills and 70% on account of the actual executed value shall be paid against the service line item including composite line item. In case this milestone is not completed beyond 120 days for reasons attributable to TPCODL, the payment corresponding to supply part shall be released subject to submission of BG of equivalent amount by the BA valid for a period of further 12 months. If required, it shall be extended by the BA on request of TPCODL.
- E. 15% payment of the actual executed Release Order/ Purchase Order shall be paid after completion of acceptance test and Taking Over of the complete systems specified in the enquiry, including clearance of Electrical Inspection, compliance of final punch point and after reconciliation & adjustment of payments, if any, towards Quantities of materials issued from purchaser's stock and consumed by the contractor for expeditious completion of the job. In case this milestone is not completed beyond 120 days beyond schedule for reasons attributable to TPCODL, the payment corresponding to supply part shall be released subject to submission of BG of equivalent amount by the BA valid for a period of further 12 months. If required, it shall be extended by the BA on request of TPCODL.

The Contractor shall submit all Operation & Maintenance manuals and "As Built Drawings" etc. and shall also submit Equipment Warranty Bank Guarantee (EWBG) equivalent to 5/10% of actual executed contract price before the release of this last payment and return of CPBG. The validity of EWBG shall be for a period of 15 months from the date of taking over of the works or specified guarantee period in drawing/tender/technical specification documents etc. whichever is later. The associate shall also submit 'No Demand Certificate' at the time of receipt of full and final payment.

#### 6.1 Pre-Requisites for Payment

- Associate should have completed execution of that part of contract, for which payment is sought, to the satisfaction of TPCODL's Engineer-in-Charge responsible for the contract and obtained certification for execution of the work.
- Associate has undertaken joint measurement of the work executed along with TPCODL's Engineer-in-charge

Doc. Title	GENERAL CONDITIONS OF CONTRACT - COMPOSITE WORKS	
Rev. No	0	Page 14 of 104

- Associate's bills/invoices submitted have been certified by Engineer-In-Charge.

## 6.2 Bills & Invoices

Unless specified otherwise in the special conditions of contract, Associate shall raise not more than one invoice/contract per month for the services rendered in the prescribed Tax Format and the invoice shall be submitted within 15 days of the following month at Bill Inward Receipt Desk (BIRD) located at Civil Lines III Office, TPCODL.

All Bills shall be supported by joint measurement of work done, quality test report and a copy of wage sheet, if applicable (showing proof of having disbursed wages as per applicable law) and a copy of statement substantiating that statutory payments having been affected.

Bills/ invoices shall mention Associate's 'Sales, Service, WCT Tax Registration Number, PAN number as applicable.

Final bill submission after completion of project or execution of job must be within 30 days from the actual date of completion/execution of work awarded.

## 6.3 Payment & Statutory Deductions

Payment shall be released within 30 days from the submission of the bills. The associate shall submit "No Demand Certificate" in the format as per Annexure-D at the time of receipt of full and final payment. In case any non-compliance to contract conditions comes to TPCODL's notice, TPCODL will be entitled to deduct 30% of estimated wages plus 20% of wages as TPCODL's overheads. Associates would be obliged to provide the copy of monthly wage sheet in any case, failing which no payment shall be made. TPCODL at their sole discretion may deposit the PF etc. with statutory authorities. TPCODL will deduct the amounts of TDS as per statutory requirement under the income tax act and the DVAT Act and certificates (wherever applicable) will be issued to associate accordingly.

In case of non-submission of PAN No TDS @ 20% shall be deducted from all payable amounts for which no TDS certificate shall be issued. TDS once deducted as above shall not be revised in any condition.

### 6.3.1 Statutory Deductions

TPCODL will deduct the amounts of TDS, TCS as per statutory requirement under the income tax act, the Goods and Services tax act, BOCW Act, or any other applicable tax act and certificates (wherever applicable) will be issued to associate accordingly. For consumption of TPCODL's Water and Electricity by Associate for execution of Contract, Associate shall pay 0.5% & 1.0% respectively of contract value and it shall be deducted from the running bills. The Engineer-in-Charge as stated in the Order shall be responsible for certification of the work executed and the bills. Bills (including original) shall be submitted in triplicate at Bill Inward Receipt Desk (BIRD) located at Civil lines-III, Near Vidhan Sabha, TPCODL.

## 6.4 Guidelines for Raising Running/Final Bills

Contract Value Up to 5 Lakhs	One Final Bill
Contract Value More than 5 lakhs	Monthly Running Bill & One Final Bill

All Bills shall be processed only when all bank Guarantees are in place and before payments of Final Bill Associate have to furnish NDC.

Doc. Title	<b>GENERAL CONDITIONS OF CONTRACT - COMPOSITE WORKS</b>	
Rev. No	0	Page 15 of 104

## **6.5 Quantity Variation**

Payment will be made on the basis of actual quantity of supplies/actual measurement of works accepted by TPCODL and not on the basis of contract quantity.

## **6.6 Full and Final Payment**

Full & Final Payment in all contracts shall be made subject to the associate submitting "No Demand Certificate" in the format as per Annexure-D.

## **7.0 MODE OF PAYMENT**

Payment shall be made through RTGS mode for which Business Associated shall submit the details of Bank Account and other details as per annexure K. Further, for any payments made, TPCODL is not responsible for any consequences/disputes Associate have among the owners channel partners, sub-Associates and all such dispute/concerns shall be settled solely by the Associate.

The quantities of items indicated are estimated and preliminary. However, payments shall be made on the basis of actual quantity of work carried out and measured jointly by the Company and the Associate. Associates shall be responsible to organize joint measurements of works with TPCODL Engineer-in-Charge before raising any bill of work done. In the event Associate fails to do so, TPCODL at their sole discretion, may take measurements of work done and proceed as deemed fit and in such an event Associate's right to lodge any subsequent claim shall stand forfeited.

## **8.0 SECURITY CUM PERFORMANCE DEPOSIT**

Associates shall submit within 15 days from the effective date of issue of PO/RC, Security cum Performance Guarantee (SPBG) in the format as per Annexure B of this document from banks acceptable to TPCODL for:

- (a) 5% of the PO value if purchase order value is more than Rs 5 Crores.
  - (b) 10% of the PO value if purchase order value is less than Rs 5 Crores.
- This shall remain valid till the end of the Guarantee Period of contract, plus one month.
- (c) 5% of the RC value in case of Rate Contract. This shall remain valid till the Guarantee period plus one month.
    - For PO/RC values less than Rs. 5 lacs, Associate may request for deduction of amount equivalent to SPBG value from their first invoice. Such amount shall be withheld by TPCODL while processing the invoice and shall be released after completion of Guarantee Period plus one month.
    - For PO/RC values less than Rs. 3 lacs, the clause (8.0) for Security cum Performance Bank Guarantee (SPBG) shall not be applicable..
    - In case of RC (Rate Contract) after the expiry of RC validity, Associate shall have to submit SPBG. However, the Associate has the option to re-submit the SPBG as per actual RO (Release Order) value issued against the RC, valid for Guarantee Period plus one month. The Guarantee Period shall be considered as per the last RO issued against the said RC. The original SPBG as submitted against the RC shall be released on submission of the new SPBG to TPCODL. Alternatively, Associate may extend the

Doc. Title	GENERAL CONDITIONS OF CONTRACT - COMPOSITE WORKS	
Rev. No	0	Page 16 of 104

validity of original SPBG only till the requisite period, i.e. Guarantee Period plus one month.

## 9.0 STATUTORY COMPLIANCE

### 9.1 Compliance to Various Acts

Associate should ensure adherence to all applicable laws, rules and regulation applicable under this contract from time to time. In case of violation any risk, costs etc shall be in associates account and keep TPCODL indemnified always till completion of contracts.

### 9.2 SA 8000

Further being TPCODL is SA 8000 complied and expects its Associates to follow guidelines of SA8000: 2014 on the following aspects

1. Child Labour
2. Forced or Compulsory Labour
3. Health & Safety
4. Freedom of Association & Right to Collective Bargaining
5. Discrimination
6. Disciplinary Practices
7. Working Hours
8. Remuneration
9. Management System

### 9.3 Affirmative Action

TPCODL appreciate and welcome the engagement/employment of persons from SC/ST community or any other deprived section of society by their business associates.

#### Relaxation in Contract Clauses under Affirmative Action for SC/ ST Business Associates\*\*

TPCODL believes that inclusive growth is the key to sustainable development, and to promote the same Policy on Affirmative Action for Scheduled Caste & Scheduled Tribe Communities has been adopted across the company.

Under the same pre-text, and to promote entrepreneurship among SC/ST community TPCODL has taken initiative by proposing relaxations in contract clauses as per below:

S. No.	Initiative	for SC/ ST BA's	Guideline Document
1	Tender Fees	100% waiver for SC/ST community	All Open Tenders
2	Earnest Money Deposit	50 % relaxation of estimated EMD value	All limited and Open Tenders
3	Performance Bank Guarantee	25% relaxation in PBG for order value above 50 lacs else 50% relaxation	All limited and Open tenders
4	Turnover	25% relaxation in company turnover under qualifying requirement criteria	All Open Tenders

Doc. Title	GENERAL CONDITIONS OF CONTRACT - COMPOSITE WORKS	
Rev. No	0	Page 17 of 104

**\*\*Classification of BA s under SC/ST shall be governed under following guidelines:**

- Proprietorship/ Single Ownership Firm: Proprietor of the firm should be from SC/ST community. Governing document shall be duly audited balance Sheet for the last FY bearing the name of proprietor.
- Partnership Firm: Only such firms shall qualify which have SC/ST partners holding equal to or more than 50% of the total ownership pattern of the firm. Governing document shall be Partnership Deed and audited balance sheet/ ITR for last FY.
- Private limited company: Only such firms shall qualify which have SC/ST directors holding equal to or more than 50% of the total ownership pattern of the firm. Governing document shall be Memorandum of Understanding (MoU) and/or Article of Association (AoA).

*## Certification from SC/ST commission shall be required for deciding upon SC/ST status of a person.*

**9.4 Compliance to Labour Laws**

Bidder needs to ensure compliance to applicable labour laws including timely disbursement of wages. In case wages are not disbursed as per the stipulated timelines, then TPCODL shall pay the wages to BA employees on behalf of BA. Apart from deducting the amount of wages paid, TPCODL shall deduct an additional service charge equivalent to 25% of the wages paid from the payment due to BA.

**9.5 Compliance to Construction and Demolition Waste Management Rules & Environment (Protection) Amendment Rules**

BA is liable to follow the Construction and Demolition Waste Management Rules- 2016, Environment (Protection) Amendment Rules- 2018 and Guidelines on dust mitigation measures in handling construction material and C&D wastes issued by CPCB.

Following are some main points of above Rules/Guidelines for Construction work, cable laying jobs etc.

1. Barricading to be provided at site to cover complete area.
2. Construction material and waste should be inside the closed area made by using barricading.
3. Water sprinkling/fine spray from nozzles to be done to suppress the dust.
4. The board of Dust mitigation measures shall be displayed at site for public viewing with required details.
5. Loose sand or soil and construction material that causes dust shall be covered.
6. Transport material that are easily wind borne need to be covered by a sheet made of either jute, tarpaulin, plastic or any other effective material.
7. All areas for storing C&D waste/construction material to be demarcated and preferably barricaded particularly those materials that have potential to be dust borne.
8. Grinding and cutting of building materials in open area shall be prohibited.
9. Construction material and waste should be stored only within earmarked area and road side storage of construction material and waste shall be prohibited.
10. No uncovered vehicles carrying construction material and waste shall be permitted.
11. Construction and demolition waste processing and disposal site shall be identified and required dust mitigation measures to be notified at the site.

Doc. Title	GENERAL CONDITIONS OF CONTRACT - COMPOSITE WORKS	
Rev. No	0	Page 18 of 104

## **10.0 QUALITY**

### **10.1 Knowledge of Requirements**

The Associate shall be deemed to have carefully examined and to have knowledge of the equipment, the general and other conditions, specifications, schedules, drawings, etc. forming part of the Contract and also to have satisfied himself as to the nature and character of the work to be executed and the type of the equipment and duties required including wherever necessary of the site conditions and relevant matters and details. Any information thus procured or otherwise obtained from TPCODL/Consultants shall not in any way relieve the Associate from his responsibility and executing the works in accordance with the terms of contract.

### **10.2 Material/Equipment/Works Quality**

The items / works under the scope of the Associate shall be of the best quality and workmanship according to the latest engineering practice and shall be manufactured from materials of best quality considering strength and durability for their best performance and, in any case, in accordance with the specifications set forth in this Contract. All material shall be new. Substitution of specified material or variation from the process of fabrication/construction/manufacture may be permitted but only with the prior written approval of the TPCODL.

### **10.3 Adherence to Rules & Regulations**

The Associate shall procure and/or fabricate/erect all materials and equipment in accordance with all requirements of Central and State enactment, rules and regulations governing such work in India and at site. This shall not be construed as relieving the Associate from complying with any requirement of TPCODL as enumerated in the Contract which may be more rigid than and not contrary to the above mentioned rules, nor providing such construction as may be required by the above mentioned rules and regulations. In case of variance of the Technical Specification from the laws, ordinance, rules and regulations governing the work, the Associate shall immediately notify the same to the TPCODL. It is the sole responsibility of the Associate, however, to determine that such variance exists. Wherever required by rules and regulations, the Associate shall also obtain the statutory authorities' approval for the plant, machinery and equipment to be supplied by the Associate.

### **10.4 Specifications and Standards**

The Associate shall follow all codes and standards referred in the Contract Document. Codes and standards of other may be followed by the Associate with the prior written approval of TPCODL, provided materials, supplies and equipment according to the standard are equal to or better than the corresponding standards specified in the Contract.

Brand names mentioned in the Contract documents are for the purpose of establishing the type and quality of products to be used. The Associate shall not change the brand name and qualities of the bought out items without the prior written approval of the TPCODL. All such products and equipment shall be used or installed in strict accordance with original manufacturer's recommendations, unless otherwise directed by the TPCODL. In any



Doc. Title	GENERAL CONDITIONS OF CONTRACT - COMPOSITE WORKS	
Rev. No	0	Page 19 of 104

circumstances the codes, specimen and standards prescribed by any government agency should not be violated.

## **11.0 SAFETY**

All Associates shall strictly abide by the guidelines provided in TPCODL's Contractor Safety Management System (CSMS) as applicable at all stages during the contract period. Associate shall execute the contracts ensuring the following in and as order of priority:

- Safety of Human Beings.
- Safety of equipment/Assets.
- Timely Completion of Contract.

Safety related requirements as mentioned in our Contractor Safety Management System is attached as annexure L and is an integral part of this GCC.

## **12.0 INSPECTION/PARTICIPATION**

### **12.1 Right to Carry Out Inspection**

TPCODL reserves the right to send its representatives for inspection or participation at various stages of contract execution listed below, applicable as per contract construction.

- During basic design and detail engineering of material/ Equipment carried out by Associate /Outsourced Agencies.
- During manufacturing stages of the product at Associate's/Associate's Outsourced Agency's Plant/Facility.
- During Pre-dispatch Inspection and Testing of finished/manufactured product at Associate's/Associate's outsourced Agency's Plant/Facility.
- During Installation & Commissioning Activities/Stages.
- Prior to Clearing of the completed installation for commissioning.
- Any other stage as find appropriate by TPCODL during contract execution time.

All inspections and participations shall be carried out within maximum of two weeks of TPCODL giving written intimation to the Associate or receiving appropriate advance written inspection call from the Associate, unless otherwise specified elsewhere in the contract document.

### **12.2 Facilitating Inspection**

The Associate shall provide all opportunities and information to TPCODL's engineers to get acquainted with the technical know-how and the methods and practices adopted by the Associate in basic and detail engineering. The Associate shall provide documents, drawings, calculations etc. as may be required by TPCODL's Engineers.

The Associate shall provide free of charge office accommodation, office facilities, secretarial services, communication facilities, general and drawing office stationary, etc. as may be reasonably required by the TPCODL's engineers. Similarly, facilities shall also be provided by Associate's outsource agencies/partners/authorized dealers (collectively termed as sub-associates) if such basic and detail engineering activities are carried out in the design offices of sub-Associates.

Doc. Title	<b>GENERAL CONDITIONS OF CONTRACT - COMPOSITE WORKS</b>	
Rev. No	0	Page 20 of 104

The Associate shall be responsible for the safety of employees of TPCODL/Third Party Agency when they are at the Associate's /Associate's outsource agency's plant or facility for carrying out/witnessing inspection/testing. All statutory safety precautions as applicable shall be followed by the Associate during Inspection Testing. If TPCODL inspectors are not satisfied with the safety arrangements at the plant, TPCODL have the right to call off inspection till such time corrective action is taken by the Associate.

Before raising the call for pre-dispatch final inspection and testing, the Associate shall conduct all the tests—type tests, routine tests etc-as specified in the contract document and submit copies of the test certificates to TPCODL along with the inspection call, for scrutiny of TPCODL.

The Associate and TPCODL shall jointly document all the observations, comments and action points after completion of inspection and it shall be binding on the Associate to provide compliance on all the points requiring compliance and furnish the compliance report to the designated authority of TPCODL for receiving clearance for dispatch of materials.

### **12.3 Third Party Nomination**

TPCODL also may nominate a third party for the purpose of carrying out the inspection and such an agency shall be entitled to all the rights and privileges of TPCODL as far as conducting the inspection.

### **12.4 Waiver of Inspections**

TPCODL on its own discretion shall chose to waive off any inspection and ask the Associate to submit all the test reports as applicable as per contract specifications, related to inspection and testing of the goods ordered for scrutiny and clearance for dispatch.

### **12.5 Incorrect Inspection Call**

In case it is observed that the material offered for inspection is not ready at the time of TPCODL inspection visit rendering it as futile, all costs towards such inspection shall be recovered from the BA. Taxes as applicable on such recoveries shall be borne by the BA.

## **13.0 MDCC & DELIVERY OF MATERIALS**

### **13.1 Material Dispatch Clearance Certificate**

Associate shall deliver material/goods/equipment against Supply Contracts or Supply Part of Composite/Service Contracts only after receiving Material Dispatch Clearance Certificate (hereafter termed as MDCC) issued by designated authority of TPCODL. Material delivered at TPCODL stores or at project site without a valid MDCC issued by the designated official of TPCODL shall be rejected. MDCC shall be issued to associate furnishing compliance report on the action points documented during pre-dispatch inspection and testing at Associate's/ Sub-Associate's plant/ facility. In case Pre-dispatch inspection is waived at the discretion of TPCODL, then, MDCC shall be issued on receiving all the test reports-routine& type-from the Associate and finding them in order.

The associate shall include and provide for securely protecting and packing the materials so as to avoid loss or damage during handling and transport by air, sea, rail and road or any other means.

All such packing shall allow to the extent possible for easy removal and checking at Site. The associate shall take special precautions to prevent rusting of steel and iron parts during

Doc. Title	<b>GENERAL CONDITIONS OF CONTRACT - COMPOSITE WORKS</b>	
Rev. No	0	Page 21 of 104

transit by sea. Gas seals or other materials shall be utilised by the associate for protection against moisture during transit of all Plant and Equipment.

Each Equipment or parts of Equipment shall be tagged with reference to the assembly drawings and corresponding part numbers. Each bale or package shall contain a packing note quoting specifically the name of the associate, item description, quantity, item / package identification.

All packing cases, containers, packing and other similar materials shall be new and supplied free by the associate and it shall not be required to be returned to the associate.

Notwithstanding anything stated in this clause, the associate shall be entirely responsible for loss, damage or depreciation or deterioration to the materials and supplies due to faulty and/or insecure packing or otherwise during transportation to the Site until otherwise provided herein.

In case of the consignments dispatched by road, the associate shall ensure that it or its sub-contractors:

- i) Identify and obtain the correct type of trucks/trailers, keeping in view the nature of consignments to be dispatched.
- ii) Take such actions as may be necessary to avoid all possible chances of damages during transit and to ensure that all packages are firmly secured.

Timelines for inspection and MDCC is as below:

S. No.	Inspection	MDCC issuance time including inspection time (max.)
1	Outside Bhubaneswar	12 days
2	Within Bhubaneswar	5 days
3	Waiver*	3 working days

\* Associate is expected to raise the inspection call assuming that Inspection shall be carried out by TPCODL. The decision for waiver of inspection shall be on sole discretion of TPCODL.

### 13.2 Right to Rejection on Receipt

Goods/Material/Equipment delivered in condition physically damaged & incomplete as a product ordered, or not packed and transported as per the terms and conditions of the contract is liable to be rejected. Such item shall be lifted back by Associates within 15 days from receipt of rejection note from TPCODL and have to supply back the material within next 30 days or within the timeframe mutually decided by Associate and TPCODL.

If delivery of the material is beyond the agreed time, Liquidated damage clause, mentioned in this GCC separately shall be applicable; but the period for levy of LD shall be considered as per the original delivery schedule and not from the agreed timelines for material rectification.

### 13.3 Consignee

Unless otherwise specified in the Contract Document, Materials/Goods/Equipment shall be consigned to "Stores-In-Charge", TPCODL Bhubaneswar.

### 13.4 Submission of mandatory documents on Delivery

Doc. Title	GENERAL CONDITIONS OF CONTRACT - COMPOSITE WORKS	
Rev. No	0	Page 22 of 104

Following documents shall be mandatorily submitted by BA along with supply of material to TPCODL stores/site:

S. No.	Documents	Requisite
1	Invoice copy in original	With all consignments
2	LR copy	Wherever required
3	Packing list	With all consignments
4	MDCC	With all consignments
5	Purchase order / Release order	Signed copy
6	Test certificates	With all consignments
7	Inspection/JVR report	In case pre-dispatch inspection is conducted
8	Device data in CD as per template for metering items	Wherever applicable

### 13.5 Dispatch and Delivery Instructions

S. No.	Instructions
1	Purchase order/ Release order no. shall be mentioned on invoice and on material
2	TPCODL material code and material description shall be mentioned in invoice and on material.
3	"Property of TPCODL" shall be embossed on material.
4	The material shall be properly sealed and packed in standard packing as per purchase order terms & conditions.
5	The weight and quantity of material shall be mentioned wherever applicable
6	The material supplied shall be co-related with the packing list.
7	The name plate detail on equipment shall include Material code, Material description, specification detail of material [as applicable], Serial No. Year of manufacturing, PO/RO no. and date, "PROPERTY OF TPCODL, Bhubaneswar", Guarantee period and Associate's name.
8	In case of manual unloading, supplier / transporter shall deploy sufficient Labour for unloading the material at TPCODL central store. For heavy item(s), crane will be provided by TPCODL [unloading cost will be recovered from the associate].
9	The driver should have valid License and one helper in truck. All the documents of truck like registration papers, PUC etc should be available in Truck.
10	BA representative should accompany the material and get it unloaded / stacked in his presence wherever possible.

### 14.0 GUARANTEE

#### 14.1 Guarantee of Performance

Associates shall stand guarantee that the equipment and material supplied/service or work rendered under the contract is free from design, manufacturing, material, construction, erection & installation and workmanship & quality defects and is capable of its due, rated and intended quality performance, as an integrated product delivered under the contract. for a specific period termed as Guarantee Period(as elaborated elsewhere in this clause) The

Doc. Title	GENERAL CONDITIONS OF CONTRACT - COMPOSITE WORKS	
Rev. No	0	Page 23 of 104

Associate should also guarantee that the equipment/material is new and unused except for the usage required for the tests and checks required as part of quality assurance.

#### **14.2 Guarantee Period**

The Guarantee Period will be equipment/service/work specific and shall be as specified in the Standard Specifications of TPCODL for the equipment/material/service/work and where standard specifications are not part of contract documents or guarantee period is not specified in the standard specifications,, the guarantee period shall be as per the Special Terms and Conditions of the Contract. In case of no mention of the guarantee period in standard specifications or SCC Guarantee Period will be 15 Months from the Date of Commissioning or 24 months from the date of delivery of final lot of supplies made, whichever is earlier.

#### **14.3 Failure in Guarantee Period (GP)**

If the equipment and material supplied/service or work rendered under the contract fails to perform its due, rated & intended quality performance, during the Guarantee period, the associate is liable to undertake repair/rectify/replace the equipment and material supplied/service or work rendered under the contract within time frame specified in the SCC or elsewhere in the contract documents at associate's cost to make the equipment and material supplied/service or work rendered under the contract of performing its due, rated and intended quality performance. If Associate fails to repair/rectify/replace the equipment or material supplied/service or work rendered under the contract, failed in Guarantee Period, TPCODL will be at liberty to get the same done at Associate's risks and costs and recover all such expenses plus the TPCODL's own charges (@ 20% of expenses incurred), from the Associate or from the "Security cum Performance Deposit" as the case may be.

If during the Warranty/ Guarantee period some parts of the supplies are replaced owing to the defects/ damages under the Warranty, the Warranty period for such replaced parts shall be until the expiry of twelve months from the date of such replacement or renewal or until the end of original Guarantee period, whichever is later.

Any repairs during the Guarantee Period shall be carried out by the Associate within 30 days of reporting the issue to Associate by TPCODL. However, if replacement of the Equipment is required, Associate shall notify the same to TPCODL within 7 days of reporting the issue by TPCODL. Thereafter, the total time for supply of new equipment/ material shall be equal to the original delivery period of that equipment/ material as specified in the Contract. In case the Associate is not able to rectify/ replace the faulty equipment/ material within the stipulated timelines as mentioned above, penalty shall be levied as per the Liquidated Damages clause mentioned in this document. The penalty amount shall be recovered from the payment due to the vendor or by encashment of the SPBG as the case may be.

#### **14.4 Cost of repairs on failure in GP**

The cost of repairs/rectification /replacement, apart from the actual cost of repairs/rectification/replacement is also inclusive of all associate costs of required transportation, site inspection /mobilization/dismantling and re-installation costs as applicable, to be borne by the Associate. The Associate has to ensure that the interruption in the usage of intended purpose of the equipment is minimized to the maximum extent In lieu of the time taken for repairs/rectification/replacement.

Doc. Title	GENERAL CONDITIONS OF CONTRACT - COMPOSITE WORKS	
Rev. No	0	Page 24 of 104

#### **14.5 Guarantee period for Goods Outsourced**

If the Associate outsources partly equipment/materials/services from third party as mutually agreed upon at the pre award stage of contract, TPCODL shall have the benefit of any additional guarantee period if provided by the third party for the part supplied/executed by them.

#### **14.6 Latent Defect**

Hidden defects in manufacturing or design of the product supplied and which could not be identified by the tests conducted but later manifested during operation of the equipment are termed as latent defects. Associates shall further be responsible for 'free replacement' for another period of THREE years from the end of the guarantee period for any 'Latent Defects' if noticed and reported by the Company.

#### **14.7 Support beyond the Guarantee Period**

The Associate shall ensure availability of spares and necessary support for a period of at least 10 years post completion of guarantee period of equipment supplied against the contract.

#### **15.0 LIQUIDATED DAMAGES**

Liquidated damages @1% of the total executed contract value per week or part thereof, for the period of delay in integrated completion, subject to maximum 10% of the value of the contract shall become leviable without prejudice to other rights of the TPCODL. This amount shall be recoverable from any amount due or becoming due to the Business Associates under this or any other contract. In specific cases, TPCODL reserves the right to apply LD only on the unexecuted portion of the supply and works for standalone use, provided full quantity is executed within a maximum 30% additional time. Deduction of LD shall be on landed cost i.e contract value inclusive of taxes and in pursuant statutory compliance GST would be applicable at the stipulated rate and the same shall be borne by Business Associate. In case of LD deduction, a GST invoice shall be issued by TPCODL as a proof of deduction/ recovery.

#### **15.1 LD Waiver Request**

Any request of LD waiver shall be submitted within thirty (30) days of deducting LD. Request submitted beyond the timeline shall not be entertained.

#### **15.2 Material Recovery**

In case of any recoveries for materials or services (for material free issued by TPCODL and not reconciled by BA or for services claimed and paid in excess at the time of running bills), the total cost which shall be recovered from the BA, shall be the gross amount of material or services (i.e. including taxes) plus applicable taxes as prevailing at the time of such recoveries.

#### **16.0 ASSIGNMENT OR SUBCONTRACTING**

Associates shall not assign/subcontract/outsource the schedule of activities of contract TPCODL enters with the associate, in part or full, without TPCODL's prior written approval.

Doc. Title	<b>GENERAL CONDITIONS OF CONTRACT - COMPOSITE WORKS</b>	
Rev. No	0	Page 25 of 104

However outsourcing of materials/equipment/services by Associate to make the integrated product for which TPCODL's has placed the contract with the associate from suppliers, makes and agencies which have been mutually agreed upon during contract pre-award stage is permitted subject to following conditions.

In such cases where outsourcing is done by the Associate

- Shall ensure that outsourced suppliers comply with the technical and financial qualification requirements specified by TPCODL in the contract document
- Shall furnish all particulars about the proposed outsourcing agencies and the details of the goods/services/work outsourced to the Associate while seeking approval of TPCODL for inclusion for outsourcing. The Associate shall give approval or shall refuse approval in writing within thirty (30) days of receipt of such request. However the Associate shall not be entitled for any additional contract execution time whatsoever in lieu of the process for approval for outsourcing agencies, and shall be held responsible for any delay in the project execution time.
- Shall remain jointly and severally liable for any action, deficiency, and/or negligence on the part of his outsourcing agencies. The approval extended by the Associate to outsourcing agencies recommended by the Associate shall not discharge the later from his Contract obligations.

Shall submit to the Associate unpriced copies of purchase orders with technical specifications included in the orders, placed on outsourcing agencies as soon as the respective orders have been placed by the Associate.

#### **17.0 UNLAWFUL ACTIVITIES**

The Associate shall have to ensure that none of its employees are engaged in any unlawful activities (whether covered under the scope of the present GCC or not) subversive of the TPCODL's interest failing which appropriate action (legal or otherwise) may be taken against the Associate by the TPCODL, in accordance with the terms of the present GCC.

#### **18.0 CONFIDENTIALITY**

Associate and its employees or representatives thereof shall strictly maintain the confidentiality of various information they come across while executing the contract as detailed below.

##### **18.1 Documents**

All maps, plans, drawings, specifications, schemes and other documents or information related to the Contract/Project and the subject matter contained therein and all other information given to the Associate by the TPCODL in connection with the performance of the contract shall be held confidential by the Associate and shall remain the property of the TPCODL and shall not be used or disclosed to third parties by the Associate for any purpose other than for which they have been supplied or prepared. The Associate may disclose to third parties, upon execution of confidentiality agreements, such part of the drawings, specifications or information if such disclosure is necessary for the performance of the Work provided such third parties agree in writing to keep such information confidential to the same extent and degree as provided herein, for the benefit of the TPCODL.

##### **18.2 Geographical Data**

Doc. Title	<b>GENERAL CONDITIONS OF CONTRACT - COMPOSITE WORKS</b>	
Rev. No	0	Page 26 of 104

Maps, layouts and photographs of the unit/plant including its surrounding regions showing vital installation for national security of country or those of TPCODL shall not be published or disclosed to the third parties or taken out of the country without prior written approval of the TPCODL and upon execution of confidentiality agreements satisfactory to the TPCODL with such third parties prior to disclosure.

### **18.3 Associate's Processes**

Title to secret processes if any developed by the Associate on an exclusive basis and employed in the design of the equipment shall remain with the Associate. TPCODL shall hold in confidence such processes and shall not disclose such processes to the third parties without prior approval of the Associate and execution by such third parties of secrecy agreements satisfactory to the Associate prior to disclosure. Upon completion of contract, such processes shall become the property of the TPCODL. Title to technical specifications, drawings, flow sheets, norms, calculations, diagrams, interpretations of test results, schematics, layouts and such other information, which the Associate has supplied to the TPCODL under the Contract shall be passed on to the TPCODL. The TPCODL shall have the right to use these for construction, erection, start-up, Trial Run, operation, maintenance, modifications and/or expansion of the works including for the manufacture of spare parts.

### **18.4 Exclusions**

The provision of Clauses 16.1 to 16.3 shall not apply to information:

- Which at the time of disclosure are in the public domain which later on become part of public domain through no fault of the party concerned, or
- Which were in the possession of the party concerned prior to disclosure to him by the other party, or
- Which were received by the party concerned after the time of disclosure without restriction on disclosure or use, from a third party who did not acquire such information directly or indirectly from the other party or has no obligation of confidentiality for such information.

### **18.5 Violation**

In case of violation of this clause, the Associate is liable to pay compensation and damages as may be determined by the competent authority of TPCODL.

## **19.0 INTELLECTUAL PROPERTY RIGHTS**

If, in the course of performance of its functions and duties as envisaged by the scope of the present GCC, the Associate acquires or develops, any unique knowledge or information which would be covered, or, is likely to be covered within the definition of a trademark, copyright, patent, business secret, geographical indication or any other form of intellectual property right, it shall be obliged, under the terms of this present GCC, to share such knowledge or information with the TPCODL. All rights, with respect to, or arising from such intellectual property, as afore mentioned, shall solely vest in TPCODL.

Moreover, the Associate undertakes not to breach any intellectual property right vesting in a third party/parties, whether by breach of statutory provision, passing off, or otherwise. In the event of any such breach, the Associate shall be wholly liable to compensate, indemnify or make good any loss suffered by such third party/parties, or any compensation/damages



Doc. Title	GENERAL CONDITIONS OF CONTRACT - COMPOSITE WORKS	
Rev. No	0	Page 27 of 104

arising from any legal proceeding/s, or otherwise. No liability of TPCODL shall arise in this respect, and any costs, damages, expenses, compensation payable by TPCODL in this regard to a third party/parties, arising from a legal proceeding/s or otherwise, shall be recoverable from the Associate.

## 20.0 INDEMNITY

The Associate shall at all times indemnify, keep indemnified and hold harmless the TPCODL and its officers, directors, employees, affiliates, agents, successors and assigns against all actions, claims, demands, costs, charges and expenses arising from or incurred by reason of any infringement of patent, trade mark, registered design, copy rights and/or industrial property rights by manufacture, sale or use of the equipment supplied by the Associate whether or not the TPCODL is held liable for by any court judgement. In this connection, the TPCODL shall pass on all claims made against him to the Associate for settlement.

The Associate assumes responsibility for and shall indemnify and save harmless the TPCODL from all liability, claims, costs, expenses, taxes and assessments including penalties, punitive damages, attorney's fees and court costs which are or may be required to be paid by the TPCODL and its officers, directors, employees, affiliates, agents, successors and assigns arising from any breach of the Associate's obligations under the Contract or for which the Associate has assumed responsibilities under the Contract including those imposed under any local or national law or laws, or in respect to all salaries, wages or other compensation for all persons employed by the Associate or his Sub-Associates or suppliers in connection with the performance of any work covered by the Contract. The Associate shall execute, deliver and shall cause his Sub-Associate and suppliers to execute and deliver, such other further instruments and to comply with all the requirements of such laws and regulation as may be necessary there under to conform and effectuate the Contract and to protect the TPCODL.

The TPCODL shall not be held responsible for any accident or damages incurred or claims arising, due to the Associate's error there from prior to completion of work. The Associate shall be liable for such accidents and after completion of work for such accidents as the case may be due to negligence on his part to carry out Work in accordance with Indian laws and regulations and the specifications set forth herein.

## 21.0 LIABILITY & LIMITATIONS

### 21.1 Liability

Except for any specific liability which may be identified in the Contract and which may be payable hereunder, Associate shall not be liable for any special, incidental, indirect, or consequential Damages or any loss of business Contracts, revenues or other financial loss (or equivalents thereof no matter how claimed, computed or characterized) arising out of or in connection with the Performance of the Work or supply of Goods ***unless caused by Associate's negligence, willful misconduct or breach of contract.***

TPCODL shall have no liability or any special, incidental, indirect or consequential Damages for any loss of Business Contracts, revenues or other financial loss arising out of this Contract.

### 21.2 Limitation of Liability

Doc. Title	GENERAL CONDITIONS OF CONTRACT - COMPOSITE WORKS	
Rev. No	0	Page 28 of 104

The total liability of Associate against any contract shall be limited to the Total All Inclusive Contract Value.

## **22.0 FORCE MAJEURE**

Force Majeure applies if the performance by either Party ("the Affected Party") of its obligations under Contract is materially and adversely affected.

"Force Majeure" shall mean any event or circumstance or combination of events or circumstances referred below and their consequences that wholly or partly prevents or unavoidably delays any Party in the performance of its obligations under this Agreement, but only and to the extent that such events and circumstances are not within the reasonable control, directly or indirectly, of the Affected Party and could not have been avoided even if the Affected Party had taken reasonable care:

- Act of war (whether declared or undeclared), invasion, armed conflict or act of foreign enemy, embargo, blockade, revolution, riot, bombs, religious strife or civil commotion, etc.
- Politically motivated sabotage, or terrorism, etc.
- Action or Act of Government or Governmental agency for which remedy is beyond the control of the affected parties.
- Any act of God.

Note: Causes like power breakdown/ shortages/fire/strikes, accidents etc do not fall under Force Majeure.

Time being the essence of the Contract, if either party is prevented from the performance of its obligations in whole or in part due to an event of Force Majeure, then provided Notice of happening of any event by the Affected Party is given to the other party within seven (7) days from the date of occurrence of such event, which DIRECTLY has impact on works and submitted details and quantum of resulting effect, but at the same time had made all possible efforts to mitigate and overcome effects thereof, the Affected Party's performance under this Contract shall be suspended until such event ceases and the Scheduled Completion shall be delayed accordingly.

If Force Majeure event(s) continue for a period of more than three months, the parties shall hold consultation to discuss the further course of action.

Neither party shall be considered to be in default or in breach of its obligation under the Contract to the extent that performance of such obligation by either party is prevented by any circumstances of Force Majeure which arise after effective date of Contract.

Neither party can claim any compensation from the other party on account of Force Majeure.

## **23.0 SUSPENSION OF CONTRACT**

### **23.1 Suspension for Convenience**

TPCODL may, at any time and at its sole option, suspend execution of all or any portions of the schedule of items of contract to be supplied/work to executed by Associate under the contract by providing to the Associate atleast two business days written notice for contracts having contract completion period less than sixty days and atleast seven business days' notice for all other contracts.

Doc. Title	<b>GENERAL CONDITIONS OF CONTRACT - COMPOSITE WORKS</b>	
Rev. No	0	Page 29 of 104

Upon receipt of any such notice, the Associate shall respond as follows as applicable as per contract construction.

- Immediately discontinue further supply of material/goods specified in the suspension notice for supply contracts
- Immediately discontinue further service/work and supply of materials of those services/materials/work specified in the suspension notice for service /composite contract
- Promptly make every reasonable effort to obtain suspension, upon terms satisfactory to TPCODL, of all orders, outsourcing arrangements, and rental Contracts to the extent that they relate to performance of the portion of Work suspended by the notice.
- Protect and maintain the portion of the service/Work already completed, including the portion of the Work suspended hereunder, unless otherwise specifically stated in the notice.
- Continue delivering/carrying out the supply/service/work items as per contract conditions, which do not fall under purview of the suspension notice.

On receipt of resumption notice from TPCODL, the Associate shall resume execution of contract as specified in the resumption notice, within the time frame specified in the resumption notice,

### **23.2 Suspension for Breach of Contract conditions.**

TPCODL shall suspend execution of whole/or part thereof the contract till such time Associate complies with the conditions stipulated under section clause 27 for breach/default of contract conditions.

### **23.3 Compensation in lieu of Suspension**

If the suspension of the contract in whole or in part is for convenience of TPCODL and not due to any breach of contract conditions by the associate, TPCODL at its discretion shall consider compensating all reasonable additional costs incurred by Associate in lieu of suspension of whole or part of contract, on representation of the Associate providing justified estimates of such additional costs and such estimates are found acceptable and approved by competent authority of TPCODL.

If the suspension of contract in whole or part thereof is due to breach of contract conditions (refer clause 24.3) by the Associate, Associate shall not be entitled for any compensation for any cost incurred in lieu of suspension of whole or part of contract and also shall be liable for compensating all the losses arising to TPCODL in lieu of suspension of contract. Resumption notice shall be subject to the Associate taking corrective action for the breach of contract conditions within the time frame and as per the terms specified in the suspension notice.

## **24 TERMINATION OF CONTRACTS**

### **24.1 Termination for Default/Breach of Contract**

The contract / PO shall be subject to termination by TPCODL in case of breach of the contract by the Associate which shall include but not be limited to the following:

Doc. Title	GENERAL CONDITIONS OF CONTRACT - COMPOSITE WORKS	
Rev. No	0	Page 30 of 104

- a. Withdrawal or intimation by the Associate of its intent to withdraw or surrender the execution / completion of the contracted work /PO or failure in ensuring adherence to any delivery schedules, in deviation of the contract/ PO.
- b. Refusal or neglect on the part of the Associate to supply material/equipment of quantity or quality as specified by TPCODL and within the timeframe as specified in the contract document or refusal or neglect to execute the services/work in terms of the agreed standards of quantity or quality and/or within the timeframe specified in the contract/PO.
- c. Failure in any respect to perform any portion of the Work contracted with promptness, diligence, or in accordance with the terms of the contract.
- d. Failure to furnish guarantees as specified and /or failure to comply with the terms thereof.
- e. Failure to furnish such relevant documents or information within the time specified which may be necessary for due execution / completion of the works and documentation.
- f. Liquidation, bankruptcy either voluntary or involuntary OR entering into any composition or compromise with its creditors, or Insolvency.
- g. In case any reasonable information has been received by TPCODL that Associate has adopted/ or attempted to adopt any unethical conduct, action in award of the contract /PO or at any time thereafter.
- h. Failure to comply with applicable statutory provisions as contained in the contract or failure to comply with the applicable laws.
- i. Failure to comply with safety regulations/clauses stipulated in the contract or as may be generally instructed by TPCODL.

If the default or breach as specified under clause 24 (except sub clause g thereof) be committed by the associate for the first time, TPCODL shall issue, along with notice of default or breach, a warning notice instructing the associate to take remedial/corrective action within the time frame stipulated in the warning notice and not to repeat the same in future. The timeframe for corrective action by the associate shall be specific to the nature of breach of contract and the same shall not be objected to by the Associate. If the Associate fails to comply with the instructions in the warning notice or in taking corrective action to the satisfaction of TPCODL then TPCODL may terminate the entire or part of contract at its discretion by issuing termination notice without incurring any liability on this ground.

In case the contract is terminated for any breach of the nature specified in clause 24 g stated above, TPCODL shall have the right to terminate all the contracts TPCODL is having with the Associate by issuing termination notice which shall be without prejudice to the other rights of TPCODL available to it under law.

Without prejudice to its right to terminate for breach of contract, TPCODL may, without assigning any reason, terminate the Contract in whole or in part at any time at its discretion while the contract is in force by serving a written notice of two weeks to the Associate.

In the event of TPCODL having proceeded with termination of the contract the associate shall comply and proceed further in the following manner:

- i) Associate shall discontinue the supply, on the expiry of the said period of two weeks.

Doc. Title	GENERAL CONDITIONS OF CONTRACT - COMPOSITE WORKS	
Rev. No	0	Page 31 of 104

ii) Associate shall ensure that no further steps are being taken towards discharge of the obligations, terms and conditions as contained in the contract/PO. This shall include initiation of actions not limited to discontinuation of other allied and associated arrangements which the associate might have entered into with third parties for due discharge of its obligations under the contract with TPCODL.

iii) The Associate shall perform thereafter such tasks as may be necessary to preserve and protect the terminated portion of the material/service/work in progress and the materials and equipment at TPCODL sites or in transit thereto. However the associate shall continue to fulfill its contractual obligations with regard to the part of contract not terminated.

iv) It shall be open for TPCODL to conduct a joint assessment with the associate of the material ,supplies, equipment ,works or in general as to the subject matter of the contract in regard to which the associate claims having completed its obligations before or during such termination.

v) It shall be open to TPCODL to seek invocation of the performance bank guarantee or any other guarantee or other security deposit by whatever name called submitted by the associate, which shall not be objected to or protested against by the associate.

In case of termination of the contract the parties agree to be governed inter alia by the following:

a) In case TPCODL exercises its right of termination as stated above the associate shall not dispute or object to the same.

b) The Associate shall be entitled to receive and claim only such payments OR sums of money from TPCODL as may be found payable to it in regard to works executed by it under the terms of the contract and no other claim of any nature whatsoever shall be made by the Associate.

c) All such provisions which the parties have agreed to survive and prevail even after termination of the contract shall remain effective despite the termination.

In the event of such termination, TPCODL may finish the Work by whatever method it may deem expedient, including the hiring of services and /or purchase of material equipment from such third parties as TPCODL may deem fit or may itself provide any labor or materials and perform any part of the Work. The associate undertakes to bear the incremental costs if any paid by TPCODL in such a case attributable to failure on the part of the associate. The Associate in such a case shall not be entitled to receive any further payments and any sums found payable to it may be adjusted by TPCODL against the amount recoverable from him on this ground. The same shall be without prejudice to other rights available to TPCODL under law against the associate.

Upon the termination of any of the contract due to occurrence of any circumstances provided in clauses stated above and constituting repeated breach or misconduct , TPCODL shall be entitled to bar the associates its agents , affiliates from undertaking any negotiation / tendering, bidding, participation activities concerning TPCODL for a period of two years from date of such termination. The same shall be without prejudice to other rights available to TPCODL.

## **24.2 Termination for convenience of Associate**

Doc. Title	<b>GENERAL CONDITIONS OF CONTRACT - COMPOSITE WORKS</b>	
Rev. No	0	Page 32 of 104

Associate at its convenience may request for termination of contract, clearly assigning the reason for such request. TPCODL has full right to accept, reject or partially accept such request. This convenience will be available to associate only after one year from the contract effective date. For this purpose, associate will provide a notice period of 90 days to TPCODL, Associate will have to pay TPCODL a 'termination convenience fee' equivalent to 5% of unexecuted contract value.

### **24.3 Termination for Convenience of TPCODL**

TPCODL at its sole discretion may terminate the contract by giving 30 days prior notice in writing or through email to the Associate. TPCODL shall pay the Associate for all the supplies/ services rendered till the actual date of contract termination against submission of invoice by the Associate to that effect.

### **25.0 DISPUTE RESOLUTION & ARBITRATION**

In case of any dispute or difference the parties shall endeavor to resolve the same through conciliatory and amicable measures within 15 Days failing which the matter may be referred by either party for resolution by the sole arbitrator to be appointed mutually by both the parties. The arbitral proceedings shall be conducted in accordance with Arbitration and Conciliation Act 1996 and the place of arbitration shall be Bhubaneswar. The language to be used at proceedings shall be English and the award of the arbitrator shall be final and binding on the parties. The parties shall bear their respective costs of arbitration. The associate shall continue to discharge its obligations towards due performance of the works as per the terms of the contract during the arbitration proceedings unless otherwise directed in writing by TPCODL or suspended by the arbitrator. Further, TPCODL shall continue making such payments as may be found due and payable to the associate for such works.

#### **25.1 Governing law and jurisdiction**

The parties shall be subject to the jurisdiction of the courts of law in Bhubaneswar and any matter arising here from shall be subject to applicable law in force in India.

### **26.0 ATTRIBUTES OF GCC**

#### **26.1 Cancellation**

The Company reserves the right to cancel, add, delete at its sole discretion, all or any terms of this GCC or any contract, order or terms agreed between the parties in pursuance without assigning any reasons and without any compensation to the Associates.

#### **26.2 Severability**

If any portion of this GCC is held to be void, invalid, or otherwise unenforceable, in whole or part, the remaining portions of this GCC shall remain in effect.

#### **26.3 Order of Priority**

In case of any discrepancies between the stipulations in General Conditions of the Contract (GCC) and Special Conditions of Contract (SCC), the GCC shall stand superseded by the SCC to the extent stipulated hereinabove while balance portion of respective clauses of GCC shall continue to be applicable.

### **27.0 INSURANCE**

Doc. Title	<b>GENERAL CONDITIONS OF CONTRACT - COMPOSITE WORKS</b>	
Rev. No	0	Page 33 of 104

The Associate shall arrange accident insurance policy for his foreign experts/specialists/personnel deputed to Site and Associate's/his sub-Associates' manufacturing works as well as for his Indian engineers and supervisory staff. The Associate shall also take out for his Indian workmen, where applicable, a separate policy as required under Workmen's Compensation Act.

Associates shall be responsible to suitably insure their entire work-force (to the extent of at least meeting requirements under Workmen Compensation Act) Tools, Plant, Third party liability at the project site, All Risk comprehensive insurance for the entire works (insurance for free issue items will be in TPCODL scope) for total contract (PO/RO) value or any other such risks during execution of works, till the works are handed over to the company, in consultation with TPCODL and shall submit copies of such insurances to the Engineer-in-Charge for review / acceptance before commencing the work. Engineer-in-charge must ensure compliance to insurance requirement by Associate before commencement of works. TPCODL shall stand fully indemnified in this respect.

### **28.0 ERRORS AND OMISSIONS**

The Associate shall be responsible for all discrepancies, errors and omissions in the drawings, documents or other information submitted by him, irrespective of whether these have been approved, reviewed or otherwise accepted by the TPCODL or not. However any error in design/drawing arising out of any incorrect data/written information from TPCODL will not be considered as error and omissions on part of the Associate.

### **29.0 TRANSFER OF TITLES**

The title of ownership and property to all equipment, installations, erections, constructions materials, drawings & documents shall pass to the TPCODL after Commissioning and complete handing over-taking over.

However, such passing of title of ownership and property to the TPCODL shall not in any way absolve, dilute or diminish the responsibility and obligations of the Associate under this Contract including loss or damages and all risks, which shall vest with the Associate.

The Associate shall take all corrective measures arising out of discrepancies, errors and omissions in drawings and other information within the time schedule and without extra cost to the TPCODL.

The Associate shall also be responsible for any delay and/or extra cost if any, in carrying out engineering, and site works by other agencies arising out of discrepancies, errors and omissions stated in as well as of any late revision/s of drawings and information submitted by the Associate.

### **30.0 SUGGESTIONS & FEEDBACK**

We welcome all our Business Associates to write to us about their experience with TPCODL; be it our Company, our services or our people. Each and every concern, issue, query and suggestion from you will help us to become a better company to work with and shall help us develop a strong bonding of trust and a long term relationship with you.

You may send your feedback by filling up our Business Associate Feedback Form enclosed herewith as Annexure-I. You can also log on to our website [www.tpcentralodisha.com](http://www.tpcentralodisha.com) to provide your feedback according to the guidelines mentioned below:

Doc. Title	<b>GENERAL CONDITIONS OF CONTRACT - COMPOSITE WORKS</b>	
Rev. No	0	Page 34 of 104

### 31.0 CONTACT POINTS

In case Business Associate needs information with respect to payments or has any grievances, same may be lodged by log on to our website [www.tpcentralodisha.com](http://www.tpcentralodisha.com)

### 32.0 LIST OF ANNEXURES

S. No.	Subject	Annexure
1.	Performa for Bid Security Bank Guarantee	A
2.	Performa for Advance Payment Bank Guarantee	B
3.	Performa for Performance Bank Guarantee (CP cum EP)	C
4.	Performa for No Demand Certificate by Associate	D
5.	Performa for Indemnification on Statutory Compliance	E
6.	Performa For Application For Issuance of Consolidated TDS Certificate	F
7.	HR Service Level Agreement	G
8.	Under taking for competence of workmen	H
9.	Business Associate Feedback Form	I
10.	Acceptance Form For Participation In Reverse Auction Event	J
11.	NEFT or RTGS payment request form	K
12.	Contractor Safety Management System	L
13.	Vendor Appraisal Form	M
14.	Manufacturers Authorization Form	N



Doc. Title	<b>GENERAL CONDITIONS OF CONTRACT - COMPOSITE WORKS</b>	
Rev. No	0	Page 35 of 104

**ANNEXURE-A**

**PROFORMA FOR BID SECURITY BANK GUARANTEE**

**TP Central Odisha Distribution Limited**

**Bhubaneswar**

WHEREAS, (Name of the Bidder) \_\_\_\_\_ (hereinafter called "the BIDDER") has submitted his bid dated \_\_\_\_\_ for the (Name of Contract) \_\_\_\_\_ (hereinafter called "the BID").

KNOW ALL men by these presents we (Name of the Bank) \_\_\_\_\_ of (Name of the Country) \_\_\_\_\_ having our registered office at \_\_\_\_\_ (hereinafter called "the BANK") are bound unto TP Central Odisha Distribution Limited (TPCODL) in the sum of \_\_\_\_\_ for which payment well and truly to be made to the TPCODL the Bank binds himself, his successors and assigns by these presents.

SEALED with the Common Seal of the said Bank this \_\_\_\_\_ day of \_\_\_\_\_ 20\_\_\_\_\_.

The CONDITIONS of this obligation are:

- i) If the Bidder withdraws his Bid during the period of bid validity specified in the Proforma of Bid
- or
- ii) If the Bidder having been notified of the acceptance of his Bid by the TPCODL during the period of bid validity fails or refuses to furnish the Contract Performance Bank Guarantee, in accordance with the Instructions to Bidders.

We undertake to pay the TPCODL upto the above amount upon receipt of its first written demand, provided that in its demand the TPCODL will note that amount claimed by it is due to it owing to the occurrence of one or both conditions, specifying the occurred condition or conditions.

This Guarantee will remain in force upto and including the date (No of days as mentioned in tender enquiry) days after the closing date of submission of bids as stated in the Invitation to Bid or as extended by you at any time prior to this date, notice of which extension to the Bank being hereby waived, and any demand in respect thereof should reach the Bank not later than the above date.

**DATE.....** **SIGNATURE** **OF** **THE**  
**BANK.....**

**WITNESS.....** **SEAL.....**

(Signature, Name & Address)

(At least 2 witnesses)

Doc. Title	GENERAL CONDITIONS OF CONTRACT - COMPOSITE WORKS	
Rev. No	0	Page 36 of 104

**ANNEXURE-B**

**PROFORMA FOR ADVANCE PAYMENT BANK GUARANTEE**

**(On Rs.100/- Stamp Paper)**

**Note:**

- (a) Format shall be followed in toto
- (b) Claim period of six months must be kept up
- (c) The guarantee to be accompanied by the covering letter from the bank confirming the signature to the guarantee

-----  
-----

**TP Central Odisha Distribution Limited**

**Bhubaneswar**

**Advance Payment B.G.No.....**

**Contract No.....dated.....**

1. You have entered into a Contract No \_\_\_\_\_ with M/s. \_\_\_\_\_ (hereinafter referred to as "the Vendor") for the supply and delivery of \_\_\_\_\_ (hereinafter referred to as "the said Equipment") for the price and on the terms and conditions contained in the said contract.
2. In accordance with the terms of the said contract, you have agreed to make an advance payment of Rs. \_\_\_\_\_ (Rupees \_\_\_\_\_ only) being \_\_\_\_\_% (\_\_\_\_\_percent) of the total value of the contract on "the Vendor" furnishing you with an irrevocable, unconditional and acceptable bank guarantee to be valid till the date of receipt of "the said equipment" covered by your above mentioned contract. For this purpose you have agreed to accept our guarantee.
3. In consideration thereof, we, \_\_\_\_\_ hereby irrevocably and unconditionally guarantee to pay to you on demand but in any case before the end of five working days from the date of the claim and without demur and without reference to "the Vendor" such amount or amounts not exceeding the sum of Rs. \_\_\_\_\_ (Rupees \_\_\_\_\_ only) being \_\_\_\_\_% (\_\_\_\_\_percent) of the total value of the contract on receipt of your intimating that "the Vendor" has not fulfilled his contractual obligations. You shall be the sole judge for such non-fulfillment and "the Vendor" shall have no right to question such judgment.
4. You shall have the right to file / make your claim on us under the guarantee for a further period of one months from the date of expiry.
5. This guarantee shall not be revoked without express consent and shall not be affected by your granting time or any other indulgence to "the Vendor", which shall include but

Doc. Title	GENERAL CONDITIONS OF CONTRACT - COMPOSITE WORKS	
Rev. No	0	Page 37 of 104

not be limited to, postponement from time to time of the exercise the same in you or any right which you may have against "the Vendor" and to exercise the same in any covenant contained or implied in the said contract or any other course or remedy or security available to you, and our Bank shall not be released from its obligations under this guarantee by your exercising any of your rights with reference to matters aforesaid or any of them or by reasons of any other act or forbearance or other acts of omission or commission on your part or any other indulgence shown by you or by any other matter or thing whatsoever which under the law would, but for this provision have the effect of relieving our bank from its obligation under this guarantee.

6. We also agree that you shall be entitled at your option to enforce this guarantee against our bank as a principal debtor, in the first instance, notwithstanding any other security or guarantee that you may have in relation to "the Vendor's" liabilities in respect of the premises
7. This guarantee shall not be affected by any change in the constitution of our Bank or "the Vendor" or for any other reason whatsoever.
8. Any claim / extension under the guarantee can be lodge-able at outstation banks or at Bhubaneswar branch and claim will also be payable at Bhubaneswar Branch **(to be confirmed by Bhubaneswar Branch by a letter to that effect)**
9. Notwithstanding anything herein contained, our liability under this guarantee is limited to Rs. \_\_\_\_\_ (Rupees \_\_\_\_\_ only) and the guarantee will remain in force upto and including \_\_\_\_\_ (Date) and shall be extended from time to time for such period or period as may be desired by "the Vendor".
10. Unless a demand or claim under this guarantee is received by us in writing within one month from \_\_\_\_\_ (expiry date) i.e. on or before \_\_\_\_\_ (claim period end date), we shall be discharged from all liabilities under this guarantee thereafter.

Dated at \_\_\_\_\_ this \_\_\_\_\_ day of \_\_\_\_\_ 200 \_\_\_\_\_

**Witness**

- |          |  |
|----------|--|
| 1. _____ | Bank's rubber stamp<br>Banks full address        |
| 2. _____ | Designation of Signatory<br>Bank official number |

Doc. Title	GENERAL CONDITIONS OF CONTRACT - COMPOSITE WORKS	
Rev. No	0	Page 38 of 104

**ANNEXURE- C**

**PROFORMA FOR PERFORMANCE BANK GUARANTEE (CP cum EP)**

**(On Rs.100/- Stamp Paper)**

**Note:**

- (a) Format shall be followed in toto
- (b) Claim period of one month must be kept up
- (c) The guarantee to be accompanied by the covering letter from the bank confirming the signature to the guarantee

-----  
-----

**TP Central Odisha Distribution Limited**

**Bhubaneswar**

**CP cum EP BG No.....**

**Order/Contract No.....dated.....**

1. You have entered into a Contract No \_\_\_\_\_ with M/s. \_\_\_\_\_ (hereinafter referred to as "the Vendor") for the supply cum erection / civil work of \_\_\_\_\_ (hereinafter referred to as "the said Equipment") for the price and on the terms and conditions contained in the said contract.
2. In accordance with the terms of the said contract, "the Vendor" agreed to furnish you with an irrevocable, unconditional and acceptable bank guarantee for 10% of the value of contract and to be valid till the end of Guarantee period plus one month towards "Contract cum Equipment performance". For this purpose you have agreed to accept the guarantee.
3. In consideration thereof, we, \_\_\_\_\_ hereby irrevocably and unconditionally guarantee to pay to you on demand but in any case before the end of five working days from the date of the claim and without demur and without reference to "the Vendor" such amount or amounts not exceeding the sum of Rs. \_\_\_\_\_ (Rupees \_\_\_\_\_ only) being \_\_\_\_\_ % (\_\_\_\_\_ percent) of the total value of the contract on receipt of your intimating that "the Vendor" has not fulfilled his contractual obligations. You shall be the sole judge for such non-fulfillment and "the Vendor" shall have no right to question such judgment.
4. You shall have the right to file / make your claim on us under the guarantee for a **further period of one month** from the date of expiry.
5. This guarantee shall not be revoked without express consent and shall not be affected by your granting time or any other indulgence to "the Vendor", which shall include but not be limited to, postponement from time to time of the exercise the same in you or any right which you may have against "the Vendor" and to exercise the same in any covenant contained or implied in the said contract or any other course or remedy or security

Doc. Title	GENERAL CONDITIONS OF CONTRACT - COMPOSITE WORKS	
Rev. No	0	Page 39 of 104

available to you, and our Bank shall not be released from its obligations under this guarantee by your exercising any of your rights with reference to matters aforesaid or any of them or by reasons of any other act or forbearance or other acts of omission or commission on your part or any other indulgence shown by you or by any other matter or thing whatsoever which under the law would, but for this provision have the effect of relieving our bank from its obligation under this guarantee.

6. We also agree that you shall be entitled at your option to enforce this guarantee against our bank as a principal debtor, in the first instance, notwithstanding any other security or guarantee that you may have in relation to "the Vendor's" liabilities in respect of the premises
7. This guarantee shall not be affected by any change in the constitution of our Bank or "the Vendor" or for any other reason whatsoever.
8. Any claim / extension under the guarantee can be lodge-able at outstation banks or at Bhubaneswar branch and claim will also be payable at Bhubaneswar Branch (to be confirmed by Bhubaneswar Branch by a letter to that effect in case BG is from the branch outside Bhubaneswar)
9. Notwithstanding anything herein contained, our liability under this guarantee is limited to Rs. \_\_\_\_\_ (Rupees \_\_\_\_\_) only and the guarantee will remain in force upto and including \_\_\_\_\_ (Date) and shall be extended from time to time for such period or period as may be desired by "the Vendor".
10. Unless a demand or claim under this guarantee is received by us in writing within one months from \_\_\_\_\_ (expiry date) i.e. on or before \_\_\_\_\_ (claim period end date), we shall be discharged from all liabilities under this guarantee thereafter.

Dated at \_\_\_\_\_ this \_\_\_\_\_ day of \_\_\_\_\_ 200\_\_

**Witness**

- |          |  |
|----------|--|
| 1. _____ | Bank's rubber stamp<br>Banks full address        |
| 2. _____ | Designation of Signatory<br>Bank official number |

Doc. Title	GENERAL CONDITIONS OF CONTRACT - COMPOSITE WORKS	
Rev. No	0	Page 40 of 104

**ANNEXURE-D**

**PROFORMA FOR “NO DEMAND CERTIFICATE” BY ASSOCIATE**

(On Company’s Letter head or with Company Seal)

(To be submitted by the Associate to TPCODL Accounts Department at the time of receipt of full and final payment)

**(Certificate No. CCP/002)**

Name of the Project

Order/ Contract No.

Dated

Name of the Associate

Scheme No. / Job No.

We, M/s. \_\_\_\_\_ (Associate) do hereby acknowledge and confirm that we have received the full and final payment due and payable to us from TPCODL, in respect of our aforesaid Order No \_\_\_\_\_ dated \_\_\_\_\_ including amendments, if any, issued by TPCODL to our entire satisfaction and we further confirm that we have no claim whatsoever pending with TPCODL under the said contract / W.O.

Notwithstanding any protest recorded by us in any correspondence, documents, measurement books and / or final bills etc., we waive all our rights to lodge any claim or protest in future under this contract.

We are issuing this “NO DEMAND CERTIFICATE” in favour of TPCODL, with full knowledge and with our free consent without any undue influence, misrepresentation, coercion etc.

**Dated**

**Signature**

**Place**

**Name**

**Designation**

**(Company Seal)**

Doc. Title	GENERAL CONDITIONS OF CONTRACT - COMPOSITE WORKS	
Rev. No	0	Page 41 of 104

**ANNEXURE – E**

**PROFORMA FOR “INDEMNIFICATION ON STATUTORY COMPLIANCES”**

(To be submitted by the successful Bidder within seven days of award of work)

**(Certificate No. CCP/001)**

Name of the Project

Letter of Award / Contract No.

Dated

Name of the Associate

Scheme No. / Job No.

By this confirmation we, \_\_\_\_\_  
(Associate) are formally bound to M/s. TPCODL towards any sum which may be imposed, levied or hereinafter recovered by the Provident Fund Organization under the provisions of the Employees of the Provident Fund and Miscellaneous Provisions Act 1952 in respect of employees employed by us.

We well and truly bind ourselves and our heirs executors administrators and representatives jointly severally and respectively for the above payment only to be paid to M/s. TPCODL.

AND WHEREAS we, \_\_\_\_\_ (Associate) is making compliance of the Employees Provident Fund and Miscellaneous Provisions Act 1952, have entered into the above written bond for the indemnity to M/s. TPCODL against all losses from the acts or default of the said Associate in respect of compliance of the Provident Fund Act.

Similarly we hereby confirm that we have complied with all statutory and local laws and nothing is outstanding with regard to Local Sales Tax, Labour Laws, Local Municipal dues, Electricity dues etc. We have entered into the above written bond for the indemnity to M/s. TPCODL against all losses from the acts or default of the said Associate in respect of compliance of the Local Sales Tax Laws, Local Laws, Labour Laws, Local Municipal Dues, Electricity dues etc.

NOW THE CONDITION, of the above written bond is as such that if the Associate during the period of this contract commits any default or fails to make payment of Contributions in respect of his employees to the Employees Provident Fund Organization, he shall indemnify the Principal Employer M/s. TPCODL from all and every loss and damage caused to them from any act, omissions or negligence of the said Associate in respect of compliances under the Employees Provident Fund and Miscellaneous Provisions Act, 1952.

IN WITNESS to the above written bond we have here to set our hands, with our free consent.

**Dated**

**Signature**

**Place**

**Name**

**Designation (Company Seal)**

Doc. Title	GENERAL CONDITIONS OF CONTRACT - COMPOSITE WORKS	
Rev. No	0	Page 42 of 104

**ANNEXURE-F**

**PROFORMA FOR APPLICATION FOR ISSUANCE OF CONSOLIDATED TDS  
CERTIFICATE**

To be printed on the letterhead

To,

TP Central Odisha Distribution Limited,

Bhubaneswar

**Sub: Application for issuance of Consolidated TDS Certificate for the FY \_\_\_\_\_**

Dear Sir,

I / we hereby request / authorize you to issue me / us a consolidate TDS Certificate for the financial year \_\_\_\_\_ against tax deducted at source by you from my / our payments / bills during the said year from time to time under Chapter XVII – B of the Income Tax Act, 1961.

For and on behalf of

Signature

Name

Address

Contact No. (Land Line)

(Mobile)

PAN #

Assessing authority

**ATTACH THE COPY OF PAN CARD**



Doc. Title	GENERAL CONDITIONS OF CONTRACT - COMPOSITE WORKS	
Rev. No	0	Page 43 of 104

## ANNEXURE - G

### SERVICE LEVEL AGREEMENT

(To be adhered to by Business Associates (BAs) in TPCODL on Human Resource Issues)

**1.0 The following shall be adhered to by the Business Associates during his / its association with TPCODL:**

**Shall Abide by TPCODL Core Values:**

- a) **Integrity** – We must conduct our business fairly, with honesty and transparency. Everything we do must stand the test of public scrutiny.
- b) **Understanding** – We must be caring, show respect, compassion and humanity to our colleagues and customers and always work for the benefit of the communities we serve.
- c) **Excellence** – We must constantly strive to achieve the highest possible standards in our day to day work and in the quality of services we provide.
- d) **Unity** – We must work cohesively with our colleagues across the group and with our customers and partners to build strong relationships based on tolerance, understanding and mutual co-operation.
- e) **Responsibility** – We must continue to be responsible and sensitive to the communities and environments in which we work and always ensuring that what comes from the people; goes back to the people many times over.
- f) **Agility**- We must work in a speedy and responsive manner and be proactive and innovative in our approach.

**2.0 The Business Associate / his manager / supervisor who is responsible for managing the project site / performance contract etc. in TPCODL would also ensure adherence of these values by his employees / persons deployed by him in connection with his works undertaken in TPCODL.**

**3.0 TPCODL is a signatory to the United Nation Global Compact as an integral part of its Governance principles / business. The Business Associates are required to:**

- a) Support and respect the protection of human rights and make sure that they are not complicit in human right abuses.
- b) Respect freedom of association and effective recognition of the right to collective bargaining.
- c) Not to resort to any form of forced and compulsory labour.
- d) Shall ensure abolition of child labour in his area of work.
- e) There is no discrimination in respect of employment and occupation in respect of his employees.
- f) Support precautionary approach to environmental challenges.
- g) Promote greater environmental responsibility by himself and his employees in his areas of work.
- h) Deploy and defuse environmental friendly technologies while carrying out the works.
- i) Work against corruptions in all its form including extortion and bribery by himself and his employees.

**4.0 The Business Associates are required to adhere to all applicable Labour Laws with special reference to the following:**

Doc. Title	GENERAL CONDITIONS OF CONTRACT - COMPOSITE WORKS	
Rev. No	0	Page 44 of 104

- a) No person below the age of 18 years and no child labour will be engaged directly or indirectly for executing the work connected with the business of TPCODL.
- b) Minimum wages along with other statutory dues like PF, ESI, etc. as applicable to the workers shall be made within the prescribed period of 7<sup>th</sup> / 10<sup>th</sup> day of the following month.
- c) Deduction / deposit / record keeping and all other requirements under Employees PF Act 1952, Employees State Insurance Act 1948 and other applicable acts (if any) shall be adhered to.
- d) Only statutorily authorized deductions (if any) shall be made in accordance with the relevant statutes.
- e) All the provisions of Contract Labour (R&A) Act 1970 shall be complied with in respect of the workers engaged for TPCODL work. The work will be commenced only after completing necessary formalities for obtaining Labour License (if applicable).
- f) Necessary registers / records, filing of returns etc. shall be maintained for verification by Statutory / TPCODL authorities.
- g) Payment of wages shall be made only in presence of and with certification of authorized representative of TPCODL or shall be made in the form of cheque / bank transfer to the employee.
- h) During the period of contract, the Business Associate will arrange for deployment of his supervisor / manager for total supervision and control of the work and their manpower. All the activities related to their manpower e.g. attendance, leave, wage disbursement etc. will be done under the supervision & control of Business Associates, While adhering to the prescribed standard / norms of production / productivity & quality. During execution of the work, Business Associate shall engage only such qualified / skilled manpower as may be envisaged / required for ensuring level of production / service into the contract / work order.
- i) Clearances as follows shall be obtained from IR & Welfare Group:
  - i. Clearance for commencement (before start of the work).
  - ii. No Objection Certificate (after completion / before final settlement).
  - iii. Copies of PF / ESI Challans shall be deposited with IR & Welfare Group every month
- j) The Business Associate shall indemnify TPCODL from any liabilities under applicable Labour Statutes.
- k) The Business Associate shall ensure safety and health of his employees and shall also maintain hygienic working environment / condition in his area of work.
- l) The Business Associate and his employee shall abide by Laws of Land and shall not violate any applicable provisions.
- m) The Business Associate appreciates with and acquiesces to the right of TPCODL as principal employer to fulfil any of his legal obligations, if he fails to do so under applicable labour laws and deduct the same from his running bills / final payments / encashing security deposit / Bank Guarantee as the case may be. If there is any further shortfall TPCODL has the right to recover the same from the Business Associate.
- n) The Business Associate ensures that person employed by him adhere to the moral and legal conduct and shall not violate any standard conduct envisaged in the premise of

Doc. Title	GENERAL CONDITIONS OF CONTRACT - COMPOSITE WORKS	
Rev. No	0	Page 45 of 104

TPCODL by all such as, Transparency, Safety, Discipline, Integrity etc. The Business Associate or his employees should refrain from corrupt practices, giving or taking bribe in connection with any TPCODL business.

**5.0 The 'Statutory Compliance Enforcement System' in TPCODL is detailed below for adherence by all concerned. Corporate IR & Welfare Group will be the process owner for implementation of the system with the help of concerned Engineer I/c or Officer I/c.**

- a) Statutory Compliance being a professed value in TPCODL Code of Conduct, the concerned Engineer / Officer in charges are requested to adhere to the provisions and advise respective Business Associates in their domain to comply in letter and spirit.
- b) Immediately after issuance of letter of intent, the authorized representative of the Business Associate will report to Corporate IR & Welfare group for completion of statutory requirements.
- c) Normally, the work will be started only after 'Clearance for Commencement of Work (CCW)' is issued by IR & W group to the Business associate. However in exceptional exigencies in engineer I/c / Officer I/c may direct the Business Associate to start the work and inform IR & W group about the same. Statutory requirements in this case may be completed parallely.
- d) First monthly bill will be released only after producing CCW to the finance department. Similarly closure of work and final settlement will be affected after issuance of no objection certificate from IR & W group.

**6.0 Requirements for 'Clearance for Commencement of Work' (CCW):**

- a) Submission of filled up Form 'A' for database (Annexure-1).
- b) Copy of PF Code allocation letter.
- c) Copy of ESI Code allocation letter.
- d) Submission of duly filled up Form IV CL(R&A) act (In case more than or equals to 20 workers during the period of contract).
- e) Submission of duly filled up Form VI A (Notice of Commencement).
- f) Copy of insurance cover note under WC Act 1923 (if applicable).
- g) Copy of Contract Agreement.
- h) Copy of indemnity bond (if applicable).
- i) Affidavit with regard to payment of wages through cheque / bank transfer only.

**7.0 Requirements during execution of work:**

- a) Copy of receipt of application for license / license (if applicable).
- b) Copy of PF Challan (latest by 26<sup>th</sup> day of every Month).
- c) Copy of ESI Challan (latest by 26<sup>th</sup> day of every Month).
- d) Copy of Wage disbursement sheet / Bank statement.
- e) Filing / Maintenance of all statutory registers / reports / returns for inspection by Statutory/ TPCODL authorities.
- f) Certification of wage disbursement by authorized representative of TPCODL.
- g) Copy of 'Labour Welfare Fund' deposit certificate / Challan.
- h) Insuring safe working practices at the work place.

**8.0 Requirements for 'No Objection Certificate' (NOC) for closure of work:**

- a) Submission of duly filled up Form VI A (Notice of Completion).

Doc. Title	GENERAL CONDITIONS OF CONTRACT - COMPOSITE WORKS	
Rev. No	0	Page 46 of 104

- b) Copy of Half yearly / Annual return for ESI / PF / CL(R&A).
- c) Consolidated copy of wage sheet of last month indicating full & final settlement of all dues like retrenchment benefit, bonus, leave encashment etc. Copy of individual declaration by employees in Form X regarding termination of employment.
- d) Confirmation certificate regarding filling up of form for transfer / withdrawal of PF by the concerned workers.

**In case any of the above are deviated / not complied with the Letter of Award/Order shall be liable to be withdrawn / cancelled.**

**Enclosure:**

- 1) Form A
- 2) Form X
- 3) Form XI
- 4) Form VI A
- 5) Form XXIV

GENERAL CONDITIONS OF CONTRACT

Doc. Title	GENERAL CONDITIONS OF CONTRACT - COMPOSITE WORKS	
Rev. No	0	Page 47 of 104

**FORM (A)**

**[To be submitted by the Business Associate to the Principal Employer within a week from LoA issuance]**

**A. Details of the Agency**

1. Name of Agency :
2. Nature of work :
3. Local Address with Ph.No. :  
(With Father's name) :
4. Permanent Address (Full) :
5. PF code no. & Place :
6. ESI Code no. & Place :
7. Name and address of :  
Sub-contractor (if any)

**B. Details of Work**

8. Name of work (as specified in LOI/LOA) :
9. LOI/LOA Nos. & Dates :
10. Period of contract (Specify Dates) :  
[Including Extension period, if any] :
11. Work Area [Department / Location] :
12. Name / Cell no. of Officer I/c :
13. Maximum No. of workers and staff to be engaged on any day during the year.
  - Supervisory Staff :
  - Workers :
14. Do you have any other contract in TPCODL : Yes/No  
If yes, furnish details:

Doc. Title	GENERAL CONDITIONS OF CONTRACT - COMPOSITE WORKS	
Rev. No	0	Page 48 of 104

15. Details of Workmen's compensation Policy, if applicable

Name of Insurance Company .....  
.....Policy No ..... Number of persons  
covered ..... Period of coverage: From ..... To .....

If no, I hereby undertake the liability arising out of Workmen's Compensation Act and Rules made there under.

**C. Details of workers to be engaged**

**No. of Workers**

S. No.	Unskilled*	Semi-skilled*	Skilled*	Clerical / Supervisory

**\* Number to be indicated**

I/We shall fulfill all obligations arising from and under all relevant law in force from time to time. I/We undertake to keep the TPCODL indemnified against any loss or liability arising out of failure of my / our abiding the relevant laws.

The name of my / our representatives is ..... to enter the TPCODL Premises on my behalf.

**Date:**

**(Signature of the Business Associate  
or his Authorized Representative)**

**This Business Associate is / will be engaged in TPCODL.**

**(Signature and seal of**

**Officer I/c of the Work)**

Doc. Title	GENERAL CONDITIONS OF CONTRACT - COMPOSITE WORKS	
Rev. No	0	Page 49 of 104

**Form X**

**Undertaking**

I \_\_\_\_\_ hereby undertake that all the dues in respect of my employment with M/s \_\_\_\_\_ for the period of \_\_\_\_\_ to \_\_\_\_\_ have been settled and final payments including retrenchment benefit have been made to me in full.

( \_\_\_\_\_ )  
\_\_\_\_\_

Date:

GENERAL CONDITIONS OF CONTRACT

Doc. Title	GENERAL CONDITIONS OF CONTRACT - COMPOSITE WORKS	
Rev. No	0	Page 50 of 104

**Form XI**

**Undertaking**

With reference to the contract job awarded by M/s TP Central Odisha Distribution Limited to M/s \_\_\_\_\_ vide work order No. \_\_\_\_\_ dated \_\_\_\_\_

I \_\_\_\_\_ on behalf of

M/s \_\_\_\_\_ hereby undertake:

1. that the dues in respect of the workmen/ employee(s) engaged by us for the said contract, payable as per the provisions of relevant statute pertaining to
  - i. wages/ salary
  - ii. PF & ESI, Bhubaneswar Labour Fund
  - iii. All other statutory obligationhas been paid /settled in full and no amount/ compliance is due/ pending.
  
2. That in case any dispute / claim is raised by the concerned workers i.r.o. any dues / payments, M/s \_\_\_\_\_ will settle the same on it's own and such liability will be borne by M/s \_\_\_\_\_
  
3. That M/s \_\_\_\_\_ hereby indemnify M/s TPCODL from any future liability i.r.o. any statutory obligation in respect of said contract.

Date:

\_\_\_\_\_  
( )

Authorized Signatory

For M/s \_\_\_\_\_



Doc. Title	GENERAL CONDITIONS OF CONTRACT - COMPOSITE WORKS	
Rev. No	0	Page 51 of 104

**FORM- VI A**

**Notice for Commencement /Completion of contract work**

I/We, Sh. / M/s \_\_\_\_\_ (Name and Address of the Contractor) hereby intimate that the contract work \_\_\_\_\_ (name of work) in establishment of the \_\_\_\_\_ (name and address of the Principal Employer) for which License No. \_\_\_\_\_ dated \_\_\_\_\_ has been issued to me/us by the Licensing Officer \_\_\_\_\_ (name of the Headquarters), has been commenced / completed with effect from \_\_\_\_\_ date / on date.

**Signature of Contractor**

**With Office Seal**

**The Inspector**

\_\_\_\_\_  
 \_\_\_\_\_

**FORM XXIV**

[See Rule 82(1)]

***Return to be sent by the Contractor to the licensing Officer (in duplicate)***

Half -Yearly Ending \_\_\_\_\_

1. Name and address of the Contractor
2. Name and address of the Establishment
3. Name and address of the Principal Employer
4. Duration of Contract: From \_\_\_\_\_ to \_\_\_\_\_
5. No. of days during the half year on which
  - (a) the establishment of the principal employer had worked
  - (b) the contractor's establishment had worked
6. Maximum No. of contract labour employed on any day during the half –year:

Men	Women	Children	Total

7.
  - (i) Daily hours of work and spread over
  - (ii)
    - (a) whether weekly holiday observed and on what day
    - (b) if so, whether it was paid for
  - (iii) No. of man – hours of overtime worked

8. No. of man days worked by

Men	Women	Children	Total

9. Amount of wages paid

Men	Women	Children	Total

10. Amount of deductions from wages, if any

Men	Women	Children	Total

Whether the following have been provided –

- (i) Canteen : \_\_\_\_\_
- (ii) Rest rooms : \_\_\_\_\_

Doc. Title	GENERAL CONDITIONS OF CONTRACT - COMPOSITE WORKS	
Rev. No	0	Page 53 of 104

(iii) Drinking water : \_\_\_\_\_

(iv) Crèches : \_\_\_\_\_

(v) First Aid : \_\_\_\_\_

**Signature of contractor**

Place \_\_\_\_\_

Date \_\_\_\_\_

GENERAL CONDITIONS OF CONTRACT

Doc. Title	GENERAL CONDITIONS OF CONTRACT - COMPOSITE WORKS	
Rev. No	0	Page 54 of 104

**ANNEXURE – H**

**UNDERTAKING FOR COMPETENCE OF WORKMEN**

Name of Associate :

Tender No. :

Item :

With reference to the tender mentioned above, I/We \_\_\_\_\_,  
 hereby undertake that the workmen/ employee(s) engaged by M/s  
 \_\_\_\_\_ for the job against said tender shall be competent in all  
 respect, commensurate to the nature of job.

Date:

\_\_\_\_\_  
 ( )

Authorized Signatory

For M/s

Seal

GENERAL CONDITIONS OF CONTRACT

Doc. Title	GENERAL CONDITIONS OF CONTRACT - COMPOSITE WORKS	
Rev. No	0	Page 55 of 104

**ANNEXURE-I**

**BUSINESS ASSOCIATE FEEDBACK FORM**

With an objective to improve our internal processes and systems, and serve you better, we solicit your valuable feedback & suggestions. It is estimated that it will take about 10 minutes to complete this survey. We assure you that your feedback shall be kept confidential. Please send the duly filled feedback form in the "TPCODL addressed - attached envelop"

**You are associated with us as**

- OEMs       Service Contractor       Material Suppliers       Material & Manpower Supplier

**You are associated with us for**

- Less than 1 year       More than 1 year but less than 3 years       More than 3 years

**Your office is located at**

- Bhubaneswar       Within 200 kms from Bhubaneswar       More than 200 kms from Bhubaneswar

**Your nearly turnover with TPCODL**

- Less than 25 Lacs       25 Lacs to 1 Crore       More than 1 Cr.

**Additional information**

<b>Your Name</b>	
<b>Your Designation</b>	
<b>Your Organization</b>	
<b>Contact Nos.</b>	
<b>Email</b>	

*We once again thank you for your participation in this survey. Please spare 10 minutes to give your feedback on following pages (Section A to E)*

Doc. Title	GENERAL CONDITIONS OF CONTRACT - COMPOSITE WORKS	
Rev. No	0	Page 56 of 104

### SECTION - A

(Please ✓ mark in the relevant box and give your remarks / suggestions / information for our improvement.).

S. No.	Parameters	1	2	3	4	5	Remarks/ Suggestion
		Do Not Agree	Slightly in Agreement	In Fair Agreement	Mostly in Agreement	Fully Agree	
1	You receive all relevant queries / tenders from us in timely manner.						
2	We provide you enough lead time to respond to our queries / tenders.						
3	We provide you adequate support (drawings, documents, clarifications, briefing etc.) to enable you meet our requirements.						
4	All following elements of our contract / purchase order are rational :						
4.1	Scope of Work						
4.2	Delivery / Execution Schedule						
4.3	Payment Terms						
4.4	Liquidated Damages						
4.5	Performance Guarantee						
5	Our purchase orders / contracts are simple, specific & easy to understand						
6	TPCODL demonstrate willingness to be flexible in administration of Contract / Purchase Order						
7	We provide timely responses / clarifications to your queries						
8	TPCODL representative you interact / coordinate with is adequately empowered to support you in meeting contractual obligations						
9	TPCODL provide you all necessary infrastructure support for timely and quality completion of work (including AMC)						
10	TPCODL Engineer-in-Charge timely certifies the jobs executed/ material supplied						

S. No.	Parameters	1	2	3	4	5	Remarks/ Suggestion
		Do Not Agree	Slightly in Agreement	In Fair Agreement	Mostly in Agreement	Fully Agree	
11	TPCODL Engineer-in-Charge efficiently supervises the job execution for timely completion of job						
12	BIRD (Bill Inward Receipt Desk) initiative has improved payment disbursement process						
13	Our approach for Inspection and Quality Assurance effective to expedite project completion?						
14	TPCODL never defaults on contractual terms						
15	In TPCODL Contracts closure is done within set time limit						
16	Our material receiving procedures are well defined and efficiently deployed to reduce mutual inconvenience						
17	Bank Guarantees are released in time bound manner						
18	Our processes related to payment / account settlement are effective.						
19	You get payments on time						
20	TPCODL Employees follow Ethical behaviour						

Doc. Title	GENERAL CONDITIONS OF CONTRACT - COMPOSITE WORKS	
Rev. No	0	Page 58 of 104

**SECTION - B**

(Please rate the following parameters on a scale of 1 to 5, where 1 - Minimum; 5 - Maximum)

SN	Parameters	1	2	3	4	5	Remarks/ Suggestion
1	How do you rate courtesy/ empathy/ attitude level and warmth of TPCODL employees you interact with from following team?						
1.1	Project Engineering						
1.2	District / Zones						
1.3	Projects/HOG (TS &P)						
1.4	Inspection & Quality Assurance						
1.5	Stores						
1.6	Metering & Billing						
1.7	Accounts / Finance						
1.8	Administration						
1.9	IT & Automation						
2	How would you rate TPCODL in comparison to your other clients in terms of <b>fairness of treatment and transparency</b> with its Business Associates?						
3	How would you rate TPCODL in comparison to your other clients in terms of <b>processes and systems to manage partnership</b> with its Business Associates						
4	How would you rate TPCODL in comparison to your other clients in terms of <b>building long term &amp; mutually relationship</b> with its Business Associates						



**SECTION-C**

Please ✓ mark in the relevant box and give your remarks / suggestions / information for our improvement.

SNo	Parameters	Certainly NO	Probably NO	Probably YES	Certainly YES	Remarks/ Suggestion
1	Based on your experience with TPCODL, would you like to continue your relationship with TPCODL?					
2	If someone asks you about TPCODL, would you talk "positively" about TPCODL?					
3	Would you refer TPCODL name to others in your community, fraternity and society as a professional & dynamic organization?					

**SECTION - D**

**If we ask you to rate us on a scale of 1 to 10, how will you rate TPCODL, that truly represents your overall satisfaction with us (please tick appropriate box) -**

1	2	3	4	5	6	7	8	9	10
---	---	---	---	---	---	---	---	---	----

Doc. Title	GENERAL CONDITIONS OF CONTRACT - COMPOSITE WORKS	
Rev. No	0	Page 60 of 104

### SECTION – E

Please ✓ mark in the relevant box and give your remarks / suggestions / information for our improvement.

Please spare your thoughts for TPCODL's improvement in particular areas of weaknesses, particularly relating to some great practices, attitudes that you have seen elsewhere in Indian and International Organizations, which you recommend TPCODL to adopt. Please give your valuable salient recommendations.

Please spare your thoughts for TPCODL's improvement in particular areas of major concerns for you. We also welcome your suggestions to adopt any best practices, attitudes that you have observed / experienced elsewhere in Indian/ International organization.

Recommendation	<i>Please tick (✓) your top 5 expectations out of the following 10 points listed below -</i>	
(Please list down improvement you expect from TPCODL)	<i>Timely payment</i>	
1	<i>Flexibility in Contracts/PO</i>	
	<i>Clarity in PO,s &amp; Contracts</i>	
2	<i>Timely response to quarries</i>	
	<i>Timely certification of works executed</i>	
3	<i>Clarity in Specs,drawings,other docs etc</i>	
	<i>Adequate information provided on website for tender notification, parties qualified etc.</i>	
4	<i>Timely receipt of material at site for execution</i>	
	<i>Performance Guarantee/EMD released in time</i>	
5	<i>Inspection &amp; quality assurance support for timely job completion</i>	

We thank you for your time and courtesy!!

Doc. Title	GENERAL CONDITIONS OF CONTRACT - COMPOSITE WORKS	
Rev. No	0	Page 61 of 104

## ANNEXURE-J

### ACCEPTANCE FORM FOR PARTICIPATION IN REVERSE AUCTION EVENT

***(To be signed and stamped by the bidder prior to participation in the auction event)***

In a bid to make our entire procurement process more fair and transparent, TPCODL intends to use the reverse auctions through SAP-SRM tool as an integral part of the entire tendering process. All the bidders who are found as technically qualified based on the tender requirements shall be eligible to participate in the reverse auction event.

**The following terms and conditions are deemed as accepted by the bidder on participation in the bid event:**

1. TPCODL shall provide the user id and password to the authorized representative of the bidder. *(Authorization Letter in lieu of the same shall be submitted along with the signed and stamped Acceptance Form).*
2. TPCODL will make every effort to make the bid process transparent. However, the award decision by TPCODL would be final and binding on the supplier.
3. The bidder agrees to non-disclosure of trade information regarding the purchase, identity of TPCODL, bid process, bid technology, bid documentation and bid details.
4. The bidder is advised to understand the auto bid process to safeguard themselves against any possibility of non-participation in the auction event.
5. In case of bidding through Internet medium, bidders are further advised to ensure availability of the entire infrastructure as required at their end to participate in the auction event. Inability to bid due to telephone line glitch, internet response issues, software or hardware hangs, power failure or any other reason shall not be the responsibility of TPCODL.
6. In case of intranet medium, TPCODL shall provide the infrastructure to bidders. Further, TPCODL has sole discretion to extend or restart the auction event in case of any glitches in infrastructure observed which has restricted the bidders to submit the bids to ensure fair & transparent competitive bidding. In case an auction event is restarted, the best bid as already available in the system shall become the start price for the new auction.
7. In case the bidder fails to participate in the auction event due any reason whatsoever, it shall be presumed that the bidder has no further discounts to offer and the initial bid as submitted by the bidder as a part of the tender shall be considered as the bidder's final no regret offer. Any offline price bids received from a bidder in lieu of non-participation in the auction event shall be outrightly rejected by TPCODL.
8. The bidder shall be prepared with competitive price quotes on the day of the bidding event.
9. The prices as quoted by the bidder during the auction event shall be inclusive of all the applicable taxes, duties and levies and shall be FOR at TPCODL site.
10. The prices submitted by a bidder during the auction event shall be binding on the bidder.
11. No requests for time extension of the auction event shall be considered by TPCODL.
12. The original price bids of the bidders shall be reduced on pro-rata basis against each line item based on the final all inclusive prices offered during conclusion of the auction event for arriving at Contract amount.

**Signature & Seal of the Bidder**

Doc. Title	<b>GENERAL CONDITIONS OF CONTRACT - COMPOSITE WORKS</b>	
Rev. No	0	Page 62 of 104

**ANNEXURE-K**

To,

DGM (Finance)

The TP Central Odisha Distribution Limited  
Bhubaneswar

**Sub: e-Payments through National Electronic Fund Transfer (NEFT) OR Real Time Gross Settlement System (RTGS)**

Dear Sir,

We request and authorize you to affect e-payment through NEFT/RTGS to our Bank Account as per the details given below:-

Vendor Code :

Title of Account in the Bank :

Account Type :

(Please mention here whether account is Savings/Current/Cash Credit)

Bank Account Number :

--	--	--	--	--	--	--	--	--	--	--	--	--	--	--	--	--	--	--	--	--

Name & Address of Bank :

Bank Contact Person's Names :

Bank Tele Numbers with STD Code :

Bank Branch MICR Code :

--	--	--	--	--	--	--	--	--	--	--	--	--	--	--	--	--	--	--	--	--

(Please enclose a Xerox a copy of a cheque. This cheque should not be a payable at par cheque)

Bank Branch IFSC Code :

--	--	--	--	--	--	--	--	--	--	--	--	--	--	--	--	--	--	--	--	--

(You can obtain this from branch where you have your account)

:

Email Address of accounts person (to

Doc. Title	GENERAL CONDITIONS OF CONTRACT - COMPOSITE WORKS	
Rev. No	0	Page 63 of 104

send payment information)

Name of the Authorized Signatory :

Contact Person's Name :

Official Correspondence Address :

We confirm that we will bear the charges, if any, levied by our bank for the credit of NEFT/RTGS amounts in our account. Any change in above furnished information shall be informed to TPCODL well in time at our own. Further, we kept TPCODL indemnified for any loss incurred due to wrong furnishing of above information.

Thanking you,

For \_\_\_\_\_

**(Authorized Signatory)**

**(Signature with Rubber Stamp)**

**Certification from Bank:**

We confirm that we are enabled for receiving NEFT/RTGS credits and we further confirm that the account number (specify Bank a/c no.) of (Please mention here name of the account holder), the signature of the authorized signatory and the MICR and IFSC Code of our branch mentioned above are correct.

This also is certified that the above information is correct as per Bank record

**(Manager's/ Officers Signature under Bank Stamp)**

Doc. Title	GENERAL CONDITIONS OF CONTRACT - COMPOSITE WORKS	
Rev. No	0	Page 64 of 104

**ANNEXURE-L**  
**CONTRACTOR SAFETY MANAGEMENT SYSTEM**

**1. OBJECTIVE**

The objective of the Contractor Safety Management System is to lay down clear guidelines for all Business Associates (including their associates, staff and agents) which would facilitate them to observe all statutory rules and regulations, comply with applicable standards of Central Electricity Authority (Measures relating to safety and electric supply) Regulations, 2010 & (safety requirements for construction, operation and maintenance of electrical plants and electric lines) Regulations, 2011, TPCODL Safety Manual and Guidelines and thus, ensure creation of safe working environment for all stakeholders of our network.

**2. SCOPE**

All contracts (minor and major) will be subject to the provisions of this document.

**Minor Contracts:** Contracts which satisfy all the criteria listed under the head “Minor Contracts”.

**Major Contracts:** Contracts which satisfy any two or more criteria listed under the head “Major Contracts”

Criteria	Minor Contracts	Major Contracts
Value of Contract	< Rs. 1500000/- (less than Rs. Fifteen Lac)	>= Rs. 1500000/- (Equal or more than Rs. Fifteen Lac)
Period	Period less than 1 year	Any period
Working on energized electrical equipment	No	Yes
Working on height (above 1.8 Mtrs from ground)	No	Yes
Work involving construction activity	No	Yes
Working with hazardous goods or chemicals	No	Yes
Work involving danger to general public	No	Yes

**Note:** Exceptions for major and minor contract are – in house software development, supply of material or equipment but no direct or indirect installation of the same material, administration contracts (courier, water supply, printing, security, transport, etc.), minor civil work like plastering at ground level or flooring, etc. The facility management (housekeeping) contract will always be treated as a minor contract.

Doc. Title	GENERAL CONDITIONS OF CONTRACT - COMPOSITE WORKS	
Rev. No	0	Page 65 of 104

### 3. INFORMATION REQUIRED AT TIME OF VENDOR REGISTRATION OR BEFORE COMMENCEMENT OF CONTRACT

- 3.1 Business Associate is required to fill the Safety Management System Questionnaire as per *annexure 1* and submit along with the vendor registration process / bid / tender document. The filled questionnaire will be scrutinized by Engineer In-charge / indenting group and recommend suitability of the BA with respect to safety requirements. The fulfilment of statutory requirements for vendor registration pertaining to labour laws etc. shall be done by BA Cell on being referred to it.
- 3.2 Business Associate is required to take suitable risk control measures mentioned against the identified Hazards and Risk document provided for all contracts as per *annexure 2*. The primary objective of this is to evaluate the understanding of the BA towards risk mitigation and employment of safe work procedures. BA is required to conduct the Hazard identification and Risk Assessment study as per the procedure and deploy more or other measures if deemed necessary.
- 3.3 Business Associate shall comply with **Statutory Requirements related to Safety and Occupational Health** and submit the "Safety Undertaking" as per *annexure 4*.

### 4. GENERAL SAFETY CONDITIONS REQUIRED TO BE FULFILLED BY BUSINESS ASSOCIATES

The requirements of the contractor safety management system applicable to the minor or major contracts related to various groups are as following –

- 4.1 Maintenance of Distribution Network – *Annexure 3.1*
- 4.2 Distribution Projects – *Annexure 3.2*
- 4.3 EHV Projects – *Annexure 3.3*
- 4.4 Maintenance of Sub transmission network – *Annexure 3.4*
- 4.5 Civil / Generation Projects – *Annexure 3.5*
- 4.6 Meter Management Group (MMG), Revenue Recovery Group (RRG), Energy Auditing Group, AMI, MRG, etc. – *Annex3.6*
- 4.7 Maintenance and Operation of Street Light. – *Annexure 3.7*

1. *Please note that hydra cranes used by any dept should be ACE Model No. FX 150 ACE SX 150, Escorts Model No. TRX 1550 or contemporary. Use of old generation hydra cranes like ACE 14XW or ACE 12 XW, etc are prohibited.*

**(Details as per Annexure attached)**

**Note:** For minor contracts, the BA shall assign the duties of Safety Representative to the Work Supervisor. Work Supervisor will deliver all duties and responsibilities of Safety Supervisor as detailed in this document.

The Business Associate (BA) having major contract will appointing Safety supervisor, engineer / manager for the TPCODL work. The BA shall make all necessary arrangements for getting their workforce safety trained and competency checked from the concerned official of TPCODL before deployment in the field. BA Cell shall recommend the suitability after competency checked by Engineer In-charge and SAFETY group (or his representative) of TPCODL. After getting the clearance from concerned official, BA cell and receiving temporary I-card issued by TPCODL, Business Associate shall commence the working.

Safety Representative of Business Associates will formally become the nodal point for safety concerns for TPCODL. **BA shall not frequently transfer or terminate the services of any of the safety representatives appointed for TPCODL work site. BA needs to ensure**

Doc. Title	GENERAL CONDITIONS OF CONTRACT - COMPOSITE WORKS	
Rev. No	0	Page 66 of 104

**that Safety representative is available at all points of time; failing which the work being carried out in the interim (period when Safety representative is not available) shall be treated as working under improper supervision and due penal provisions shall be initiated against the BA.** BA will be required to provide all applicable infrastructure and power to ensure smooth working of the safety representative to maintain a sound safety management system. **In all contracts safety representative will not be assigned any other activity at site apart from the works related to safety management. The duties are detailed in clause 5.5 of this document.** TPCODL will be auditing the facilities provided to the BA's safety team time to time.

The Safety Representative of the BA shall be required to meet and follow the instructions of the Engineer In-charge and SAFETY Group of TPCODL. He shall be responsible for providing the MIS and/or any other relevant information, as and when desired, within the stipulated time frame as per the requirements of TPCODL. Any non-conformance to safety will lead to the negative marking or issue of safety violation challan/ tokens which shall affect the monthly evaluation and performance of BA.

All contracts where BA has to depute vehicle for their staff and equipment to move from one location to other, the BA shall ensure that vehicle complies all required statutory clearances and requirement as per The Motor Vehicle Act, 1988 as well as TPCODL Road Safety Policy and are in good & safe state of working.

## **5. QUALIFICATION AND EXPERIENCE OF THE SAFETY AND SITE PERSONNEL**

Qualification and experience required for the safety and site personnel are as following:

**5.1 Safety Supervisor:** It is mandatory that educational qualification of safety supervisor be ITI (of relevant trade) / Diploma (Any branch of engineering) and he has a working experience on electrical system / relevant field of work at least 5 yrs for ITI and 3 years for Diploma holder. Having formal experience of the safety systems will be an added advantage

**5.2 Safety Engineer:** It is mandatory that educational qualification of safety engineer be at least Diploma (relevant branch) and he has working experience on electrical system of at least 3 yrs. Having the formal experience of the safety systems will be an added advantage.

**5.3 Safety Manager:** The educational qualification of safety manager should be graduate engineer with working experience on electrical system / network of at least 3 yrs. OR Diploma in Industrial Safety with working experience of 05 years including at least 02 years on electrical network.

However, clause 5.1, 5.2 and 5.3 are not applicable for minor contracts. In such cases, BA shall assign the duties of Safety Representative to the Work Supervisor. Work Supervisor will deliver required duties of Safety Representative (as per clause 5.5) in addition to other duties without diluting the importance of safety.

**5.4 Site Skilled Personnel:** For all responsibility related to site activities and operations, the BA shall employ only qualified and skilled persons and shall comply the provisions of section 19 & 29 of Central Electricity Authority (Measures relating to safety and electric supply) Regulations, 2010. Persons holding valid approvals only by any Government approved agency or a competency assessment panel or a team set up by TPCODL



Doc. Title	GENERAL CONDITIONS OF CONTRACT - COMPOSITE WORKS	
Rev. No	0	Page 67 of 104

shall be allowed to perform the High Risk / High Hazard activities (refer page 1). The skill / qualification required for the electrician and electrical supervisor are given in *annexure 5*. The contracts related to maintenance of Distribution Network, Distribution Projects, EHV Projects, maintenance of Sub-Transmission Network, MMG & EAG, maintenance and operation of street lights, shall preferably have at least 20 per cent of ITI qualified electricians in the first year of the contract. This figure shall preferably be incremented by 15 per cent every subsequent year.

*Note: For the competency assessment may please refer the work instructions. An employee shall have to necessarily undergo the competency assessment check once in every eighteen months.*

#### **5.5 Requirements from the Safety Representative(s) of the Business Associate:**

- 5.5.1 Safety training of 2 hrs/employee/month and one day of safety induction training to all new employees joining the BA will be conducted by the BA as per Safety training modules of TPCODL.
- 5.5.2 Safety Talk / tool box talk before start of shift to BA employees.
- 5.5.3 Ensuring the availability & proper usage of the standard safety equipment (PPE)
- 5.5.4 Periodic inspection of PPE to ensure their serviceability and maintaining the 10% buffer stock of standard PPEs.
- 5.5.5 Ensuring the adherence to standard operating procedures of TPCODL as mentioned in TPCODL Safety standard and O & M and concerned function's manual.
- 5.5.6 Safety inspections / audits as per the process of TPCODL
- 5.5.7 Working in close coordination SAFETY Group of TPCODL.
- 5.5.8 Reporting of unsafe acts, unsafe conditions, near miss, incident or accident to Engineer In-Charge and SAFETY Group of TPCODL immediately after its occurrence.
- 5.5.9 Regular HIRA at site and comply the control measures as stated in the detailed HIRA as per the *annexure 2*. Also deployment of JSA based checklist shall be ensured.
- 5.5.10 Ensuring compliance with safety and other laws as may be applicable and providing for safety assurance.

#### **5.6 Training and Syllabus:** The BA shall not deploy any person at work place / site or send newly recruited personnel directly to concerned official for competency assessment without Safety Induction Training.

5.6.1 All new BA employees have to necessarily undergo one and half days Safety training and Competency assessment at training centre of BA cell. This training will be conducted once in a week. After the completion of Safety training & Competency assessment I-card will be issued to all competent BA employees

5.6.2 BA is expected to initially train and judge the capability of the workman at his own end before further recommending the workmen for Competency assessment. If any BA workman sent for competency assessment. In case any BA workman fails in the Competency test at concerned official, it will be deemed that BA has not imparted sufficient training at his end and actual cost of training ₹ 7500/ BA employee/ failed attempt will be recovered.

5.6.3 The workers who have imparted Safety Training and issued I-Cards of TPCODL, are not deployed at TPCODL worksites/ voluntarily left the job by workers/ used somewhere else other than TPCODL by the BA, in that case Management reserves the rights to intervene and recover the actual cost of training i.e. ₹ 7500/BA employee. (*Exempted for attrition rate of BA workers less than or equal to 10% of total workforce deployed at TPCODL*)

Doc. Title	GENERAL CONDITIONS OF CONTRACT - COMPOSITE WORKS	
Rev. No	0	Page 68 of 104

5.7 It is desired that Safety representative of the BA to impart the general safety training to each employee of duration 2 hrs per month. The training will be organized at BA level and the record to be sent to engineer in-charge and SAFETY group of TPCODL every month. Please refer schedule and syllabus in *annexure 6*.

**List of Personal Protective Equipment (PPE) and Maintenance schedule:** BA shall commence the project or any work only when the required PPE are made available to the team of employees involved in the work. Each PPE of BA shall be checked / inspected by the safety representative / supervisor at zone before the work start or as prescribed in the list. Safety representative shall regularly check the healthiness of each PPE allocated to lineman. Suitable record shall be maintained at zone. Defective PPE shall be immediately replaced or within 24 hours by the BA. In no case linemen or any other official of BA may be allowed to work with defective PPE. It is preferred that BA ensures minimum stock of each PPE at zone for immediate replacement with defective one. The PPE shall be IS / BS / CE marked and exactly as per the standard or specification mentioned in the *annexure 7*. Working without PPE / non-standard PPE shall be treated as safety violation and penalty as stated in section 6.0 of this document. If TPCODL finds that BA has not provided the adequate / appropriate PPE to their staff, TPCODL reserves the rights to stop the work and call the BA to provide appropriate PPEs at the risk. If the BA fails to provide the required PPEs at the risk then the same shall be provided by TPCODL at the actual cost of the PPE. The amount shall be charged to BA and same shall be first recovered from the current bill of BA or any future payment to be made to BA. In the event of any balance amount still left for recovery, the same shall be adjusted against retention amount or by invoking bank guarantee submitted by BA.

**5.8 Safety Audit / Inspection & HIRA:** The BA shall get the required safety inspection / audit conducted by his technical team comprising of safety representative as per the *annexure 8*. The safety representative will be required to conduct the HIRA (Hazard Identification and Risk Assessment) *as per annexure 2* of the process and work undertaken at least two times in a year or every time if a new process / activity / machine is introduced or whenever an accident take place. The risk identified to be addressed suitably with –

- Engineering Control
- Management Control, and
- Personal Protective Equipment.

The safety representative of BA shall inform and educate for the identified risk and hazard control methods to employees, supervisor and engineer as well as the engineer in-charge and SAFETY group of TPCODL.

**5.9 Safety Performance and Safety MIS:** The BA shall maintain good practice of safety all through the contract duration. Safety shall always be of paramount importance during the contract period. Safety performance will be monitored on yearly basis throughout the period and no relaxation will be given for bad performance. BA with good track record and excellent performance will be rewarded suitably as per clause 6.0 of this document. The BA has to provide monthly “Performance Report – Safety” to engineer in-charge and SAFETY group TPCODL this shall be part of monthly bill along with training details. Performa of the report is enclosed as *annexure 9*.

**5.10 Pre – Employment Medical Check-up and Fitness of employees engaged for the critical works:** The BA shall submit the health fitness certificate for all those workers involved in climbing the pole or working at height for following diseases:

5.10.2 Epilepsy

Doc. Title	GENERAL CONDITIONS OF CONTRACT - COMPOSITE WORKS	
Rev. No	0	Page 69 of 104

- 5.10.3 Colour blindness
- 5.10.4 Deafness
- 5.10.5 Vertigo & height phobia

Every year BA will give an undertaking stating that all the employees are fit to work and have not developed aforesaid diseases. The Record of such medical check-ups shall be submitted to BA Cell before issue of temporary identity card. The records shall be maintained at BA Cell. All such medical check-ups shall be repeated once in a year for all workers involved in climbing the pole or working on electrical network.

## 6. REWARD AND PUNITIVE MEASURES

**6.1** To support the enforcement of good SHE & DM practices by the Business Associate and to eliminate repeated or continuing safety violations, use of appropriate reward and punitive measures shall be made. Each unsafe act or violation of the safety guidelines as described in the Safety Manual of the TPCODL will be audit criteria of this system. Broadly the measures identified are following:

- 6.1.1 Working without PPE/ Safety Gadgets
- 6.1.2 Working without proper tools and tackles, barricading, Poor condition of Crane / Hydra / Vehicle, using without certification / Licence, Incompetent driver/ Helper
- 6.1.3 Working without creation of effective safety zone
- 6.1.4 Improper Supervision at worksite, Lineman/ Supervisor working without competency
- 6.1.5 Working without adherence to PTW process or authorization/ not adherence to SOPs / W.I. of TPCODL.
- 6.1.6 Improper Working at height equal to or above 1.8 mtrs without taking proper fall protection measures/ Poor condition of Ladder

### 6.2 Measures of Reward and Punitive Measures

The Engineer In-Charge, NSO, SC, ASOs, CSI / SIs and SHE &DM group will conduct the surprise audits of the work / project and if any non-conformance is found the same will be booked and entered in the format "Safety Violation Record" *annexure 10*. The flow of the information is given below:

Safety Violation Escalation & Monitoring process	
Action	Responsibility
Safety Violation form has been filled and counter foil sent to SAFETY team for information. The main form is to be given to BA supervisor / Engineer in-charge. <i>(Automatically generated if Site audit done through Mobile App.)</i>	Engineer In-charge/ NSO / SC / SAFETY Group /CSI/ ASO/ Any authorised TPCODL official.
↓	
Entry of the violation in the master record and sending the information to concerned Manager, HoG, HoD, Head and Chief (O &S). <i>(Automatically generated if Site audit done through Mobile App.)</i>	SAFETY Group
↓	
Forwarding the information Centralized Account Payable (CAPS) for amount deduction from the current bill of the BA,	Engineer In-charge

<i>if any.</i>	
↓	
HoG (Safety – II) & HoG (Safety & Quality – Commercial) and CAPS to generate the MIS of the violations and the amount deducted.	SAFETY Group
↓	
The pool of the amount generated after the deduction to be utilized in safety welfare of BA employees.	SAFETY Group with approval of CFO/Chief (O & S) /CEO&MD

The safety violations have been rated from 1 to 5 (figure 6.3) as per the gravity of the violation. If the same violation is repeated it may escalate into a higher penalty. If a particular Business Associate employee violates safety norms three times, he shall not be allowed to work in TPCODL for a period of one year from the date of the 3<sup>rd</sup> violation.

### 6.3 Safety Violation Escalation Matrix

#### 6.3.1

Consequence of Safety Violation Observed (Not related to Incident/ Accident)		Violation				Subsequent Violations
S.No.	Safety Violation	1st	2nd	3rd	4th	
1	Working without PPE (Helmet/Gloves/Safety Harness/ Safety Shoes etc.)	A	B	C	D	Will attract the same penalty as applicable in the 4th violation.
2	Improper Working at Height	A	B	C	D	
3	Working without proper tools and tackles	A	B	C	D	
4	Poor condition of Crane/Hydra/ Vehicle/Incompetent driver/ Helper	A	B	C	D	
5	Violation of SOP/ WI	B	C	D	E	
6	Working without adherence to PTW process or authorization/ Safety Zone	C	D	E		
<b>Legend</b>		<b>Action to be taken</b>	<b>Responsibility</b>	<b>Penalty Amount (in Rs.)</b>		The number of violations are to be calculated cumulatively over the contract period and not on monthly basis.
A	Warning letter	Engineer Incharge	Nil			
B	Levy of Penalty	Engineer Incharge	2,000			
C	Memo to BA & Levy of Penalty	Head of Group	4,000			
D	Memo to BA & Levy of Penalty	Head of Department	10,000			
E	Memo to BA, Levy of Penalty and termination of Contract	Head of Department	1,00,000			

Figure 6.3 (1a)-Penalty Matrix for Safety violation (Applicable for Minor Contracts)

Consequence of Safety Violation Observed (Not related to Incident/ Accident)		Violation				Subsequent Violations
S.No.	Safety Violation	1st	2nd	3rd	4th	
1	Working without PPE (Helmet/Gloves/Safety Harness/ Safety Shoes etc.)	B	C	D	D	Will attract the same penalty as applicable in the 4th violation.
2	Improper Working at Height	B	C	D	D	
3	Working without proper tools and tackles	A	B	C	D	
4	Poor condition of Crane/Hydra/ Vehicle/Incompetent driver/ Helper	B	C	D	E	
5	Violation of SOP/ WI	C	D	E		
6	Working without adherence to PTW process or authorization/ Safety Zone	C	D	E		
<b>Legend</b>		<b>Action to be taken</b>	<b>Responsibility</b>	<b>Penalty Amount (in Rs.)</b>		The number of violations are to be calculated cumulatively over the contract period and not on monthly basis.
A	Levy of Penalty	Engineer Incharge	5,000			
B	Memo to BA & Levy of Penalty	Engineer Incharge	10,000			
C	Memo to BA & Levy of Penalty	Head of Group	25,000			
D	Memo to BA & Levy of Penalty	Head of Department	50,000			
E	Memo to BA, Levy of Penalty and termination of Contract	Head of Department	1,00,000			

Figure 6.3 (1b)-Penalty Matrix for Safety violation (Applicable for Major Contracts)

Doc. Title	GENERAL CONDITIONS OF CONTRACT - COMPOSITE WORKS	
Rev. No	0	Page 71 of 104

Once the BA reaches the “BLACK” (color – “5”) category, i.e. highest level of safety violation, “Termination” notice to BA will be issued from the office of the Head of Department (equivalent to Addl GM/ GM/ Sr. GM level) and further, *if required*, continuation / extension of contract will only be initiated by Functional Head of the department (equivalent to Sr. GM / VP level) and approved by CEO & MD. Till the extension, the contract will remain suspended.

TPCODL encourages the reportage of the safety violation during the contract work by BA. Any TPCODL employee can register a safety violation against the BA in the “Safety Violation Form” *annexure 10*. Initially the observer has to fill the form and handover the counterfoil (lower portion) of the document to the supervisor of the BA, inform the site engineer of TPCODL and send the top portion of the Safety Violation Form to SAFETY group for the further necessary action against the BA. **The cumulative nos. of Safety Violations pertaining to any particular BA shall be calculated on yearly basis.**

Safety violations resulting in incident / accident will be treated as per gravity of the injury / fatality and its impact as well as type i.e. minor or Major. Consequences of incident / accident are shown in the matrix (figure 6.3(2) for major and 6.3(3) for minor) below. In case of any accident, findings and recommendations of Accident Enquiry Committee will be final and binding and will supersede the arbitration clause of GCC.

Consequence Of an Incident / Accident (In case of <b>MAJOR</b> contract)		Incident / Accident				Action Required
Sl. No	Type of the injury	1st	2nd	3rd	4th	
1	Slight injury (First Aid Case)	<b>F</b> (Strengthening of process through continuous improvement in the work procedure)				Take risk reduction measures
2	Minor injury (No or Hospitalization less than 48 Hrs)	<b>F</b>	<b>G</b>	<b>G</b>	<b>H</b>	
3	Major injury (Bone injury or burn or Hospitalization more than 48 Hrs)	<b>G</b>	<b>G</b>	<b>H</b>	<b>I</b>	
4	Single fatality	<b>J</b>	<b>K</b>			Intolerable
5	Multiple fatalities (Two or more fatalities during one event)	<b>K</b>				
Legend	Action to be taken	Responsibility	Penalty (in Rs.)	The number of violations are to be calculated cumulatively over the contract period and not on monthly basis.		
<b>F</b>	Memo to BA and levy of penalty	Engineer Incharge	5,000/-			
<b>G</b>	Memo to BA and levy of penalty	Head of Group	20,000/-			
<b>H</b>	Memo to BA and levy of penalty	Head of Group	50,000/-			
<b>I</b>	Memo to BA and levy of penalty	Head of Department	2,00,000/-			
<b>J</b>	Memo to BA and levy of penalty	Head of Department	5,00,000/-			
<b>K</b>	Memo to BA, levy of penalty, termination of contract and black listing of BA	Functional Head	10,00,000/-			

Figure 6.3 (2) - Penalty Matrix for Incident / Accident in Major Contracts

(For example: In major contracts, if there is first incidence of major injury say bone injury (Cat. 3) where worker was hospitalized for more than 48 hrs then a penalty of amount Rs.20000/- will be deducted from the current bill produced for the payment. This penalty will be similar for first two incidents. However, it will increment to next higher category i.e. Rs. 50,000/- on subsequent incidents as per the above matrix)

Doc. Title	GENERAL CONDITIONS OF CONTRACT - COMPOSITE WORKS	
Rev. No	0	Page 72 of 104

Consequence Of an Incident / Accident (In case of <b>MINOR</b> contract)		Incident / Accident				Action Required
Sl. No	Type of the injury	1st	2nd	3rd	4th	
1	Slight injury (First Aid Case)	<b>L</b> <small>(Strengthening of process through continuous improvement in the work procedure)</small>				Take risk reduction measures
2	Minor injury (No or Hospitalization less than 48 Hrs)	<b>L</b>	<b>M</b>	<b>M</b>	<b>N</b>	
3	Major injury (Bone injury or burn or Hospitalization more than 48 Hrs)	<b>M</b>	<b>M</b>	<b>N</b>	<b>O</b>	
4	Single fatality	<b>P</b>	<b>Q</b>			Intolerable
5	Multiple fatalities (Two or more fatalities during one event)	<b>Q</b>				
Legend	Action to be taken	Responsibility	Penalty (in Rs.)	The number of violations are to be calculated cumulatively over the contract period and not on monthly basis.		
<b>L</b>	Memo to BA and levy of penalty	Engineer Incharge	5,000/-			
<b>M</b>	Memo to BA and levy of penalty	Engineer Incharge	10,000/-			
<b>N</b>	Memo to BA and levy of penalty	Head of Group	25,000/-			
<b>O</b>	Memo to BA and levy of penalty	Head of Department	1,00,000/-			
<b>P</b>	Memo to BA and levy of penalty	Head of Department	3,00,000/-			
<b>Q</b>	Memo to BA, levy of penalty, termination of contract and black listing of the BA	Functional Head	5,00,000/-			
<b>Figure 6.3 (3) - Penalty Matrix for Incident / Accident in Minor Contracts</b>						

(For example: In minor contracts, if a worker meets with a non-fatal accident say bone injury (Cat. 3) where he was hospitalized for more than 48 hrs then a penalty of amount Rs. 10,000/-, will be charged from the current bill produced for the payment. This penalty will be similar for first two incidents. However, it will increment to next higher category i.e. Rs. 25,000/- on subsequent incidents as per the above matrix.)

In case of single or multiple fatalities described under legends J&K of 6.3(2) and P&Q of 6.3(3), the concerned BA may be debarred from extension of contract or participate in new contract. In such event the approval of Chief (O & S) will be necessary for extension or award of new contract to concerned BA.

### 6.3.2 COMPENSATION FOR BA PERSONNEL

In the event of any untoward incident/ accident, the Business Associate shall ensure prompt medical assistance such as treatment, sickness benefit, etc. is provided to the victim(s) as per the Employees' Compensation Act, 1923 or Employees' State Insurance Act, 1948, as applicable. Also, the BA will be required to take adequate measures for compensating the victim(s) or his/her/their kin as follows:

#### I. For Death or Permanent / Total Disablement

The BA shall take an insurance coverage of at least Rs. 10 lakhs for each engaged employee, to cover any incidence of Death or Permanent / Total Disablement (Permanent/Total Disability shall be considered as defined under Employees' Compensation Act, 1923). In the event of any such unfortunate incident, the BA would ensure that adequate compensation is paid immediately to the family of the victim(s) from his own resources. This compensation shall be covered under the insurance policy subscribed by the BA mentioned earlier and the arrangement should be such that it would get reimbursed to the BA by the insurance agency subsequently.

Doc. Title	GENERAL CONDITIONS OF CONTRACT - COMPOSITE WORKS	
Rev. No	0	Page 73 of 104

## II. For Permanent Partial Disablement and Temporary Total Disablement

The compensation in this case will be as per provisions of the Employees' Compensation Act, 1923 or Employees' State Insurance Act, 1948, as applicable.

Accordingly, the BA shall obtain a suitable Insurance Policy on award of Contract and submit documentary evidence of the policy to the BA Cell before commencement of work. The BA shall ensure that the Insurance policy is active at all times and all employees are covered in all respects till the conclusion of contract period or till working with TPCODL. The BA shall submit a copy of the policy after periodic renewals to the BA Cell.

However, on occurrence of such unfortunate incident, if it is found that the victim(s) is/are not covered under any insurance policy, the BA shall be liable to pay the entire sum of Rs. 10 lakhs from his own resources.

Further, in case of an accident resulting in Death or Permanent / Total Disablement while on duty, the appointed BA Nodal Officer will ensure that the BA complies with all statutory provisions and benefits i.e. PF, Compensation, Gratuity etc., and that all these are made available to the employees' nominee(s) as per the stipulated timelines.

**6.3.3** TPCODL rewards the BA with good track record of safety management. It is proposed that BA complying with Contractors Safety Management, Safety Manual and Safety process will be rewarded suitably as per the procedure, rule and regulations of the TPCODL. In any case major accident is reported during an assessment period BA will not be eligible for this reward scheme. Assessment of contracts will be once in year. Generally the assessment cycle is calendar year and guidelines will be declared time to time.

### Abbreviations Used in the Document

TPCODL	TP Central Odisha Distribution Limited
BA	Business Associate
HIRA	Hazard Identification & Risk Assessment
JSA	Job Safety Analysis
EHV	Extra High Voltage
SAFETY	Safety, Occupation Health, Environment & Disaster Management
MMG	Meter Management Group
EAG	Energy Audit Group
PPE	Personal Protective Equipment
SOP	Standard Operating Procedures
CSI/SI	Circle Safety In-charge / Safety In-charge
ASO	Area Safety Officer
NSO	Nodal Safety Officer
SC	Safety Coordinator
HoG / HoD	Head of Group / Head of Department
AGM / GM / VP	Assistant General Manager / General Manager / Vice President

Doc. Title	<b>GENERAL CONDITIONS OF CONTRACT - COMPOSITE WORKS</b>	
Rev. No	0	Page 74 of 104

CFO / Chief (O & S)/ CEO & MD	Chief Finance Officer / Chief (Operating & Safety) / Chief Executive Officer & Managing Director
COS	Corporate Operation Services
CAP	Centralized Account Payable System
PTW	Permit To Work
GCC	General Conditions of Contract.

- END -

GENERAL CONDITIONS OF CONTRACT



Doc. Title	GENERAL CONDITIONS OF CONTRACT - COMPOSITE WORKS	
Rev. No	0	Page 75 of 104

**Annexure 1 (Refer Para 3.1)**

***Business Associate Safety Management System Questionnaire***

Certification					
The information provided in this questionnaire is a summary of the company's occupational health and safety management system.					
Company Name:					
Turnover and experience:		Name of top officer:			
Date:		Position			
Contract Details					
Contract Name			Contract Number:		
Business Associates Safety Management System Questionnaire		Marks	Yes	No	Score achieved
<i>Safety Policy and Management</i>					
- <b>Is there a written company Safety policy?</b>		1			
- If yes provide a copy of the policy, if No please refer Note 1.					
- <b>Does the company have an Safety Management system</b>		1			
- If yes provide details, if No please refer Note 1.					
- <b>Is there a company Safety Management System manual or plan?</b>		2			
- If yes provide a copy of the content page(s), if No please refer Note 1.					
- <b>Are Safety and occupational health responsibilities clearly identified for all levels of Management and staff?</b>		2			
- If yes provide details, if No please refer Note 1.					
<i>Safe Work Practices and Procedures</i>					
- <b>Has the company prepared safe operating procedures or specific safety instructions relevant to its operations and relevant work as per contract?</b>		1			
- If yes provide a summary listing of procedures or instructions, if No please refer Note 2.					

Certification				
- Comments				
- <b>Is there a register of injury or accident?</b> - If yes provide a copy (format)	1			
- <b>Is there a documented incident or accident investigation procedure?</b>  - If yes provide a copy of a standard incident report form, if No please refer Note 2.  - Comments	1			
<i>Safety Training</i>				
- <b>Describe how occupational health and safety training is conducted in your company</b>  If No please refer Note 1.	2			
- <b>Is a record maintained of all training and induction programs undertaken for employees in your company?</b>  - If yes provide examples of safety training records, if No please refer Note 2.	1			
- <b>Are regular safety inspections / audits are undertaken at worksites?</b>  -If yes provide details (formats), if No please refer Note 3.	1			
- <b>Is there a procedure by which employees can report hazards at workplaces?</b>  - If yes provide details if No please refer Note 1.	1			
<i>Safety Monitoring</i>				
- <b>Is there an officer / supervisor responsible for monitoring workplace / worksite safety?</b>	1			

Doc. Title	GENERAL CONDITIONS OF CONTRACT - COMPOSITE WORKS		
Rev. No	0	Page 77 of 104	

Certification				
- If yes provide details				
<i>Safety Performance Monitoring</i>				
- <b>Are employees regularly provided with information on company health and safety performance?</b>	1			
- If yes provide details				
- <b>Has the company ever been convicted of an occupational health and safety offence?</b>	NO Marks (Negative mark ONE for each case)			
- If yes provide details				
- Has there been any major accident of employee at TPCODL site in past	NO Marks (Negative mark ONE for each case)			
- Has there been any fatal accident of employee at TPCODL site in past. - (Note: Bid evaluation committee has to take cognizance of the incident and shall evaluate the bid only after formal approval of competent authority i.e. CTO. - In case of yes please refer Note 4.	NO Mark (Negative mark FIVE for each case)			
Minimum of 75% marks is required for qualification.		Total Marks achieved		
<i>Company Reference</i>				
1. Name of company 2. Name of company				

**Note**

1: If company does not have formal procedure on Safety Management System than vendor may submit proposed Safety road map along with safety action plan and brief safety policy on his letter head signed by head of the organization.

2: The vendor may submit the same in the Safety Action Plan.

3: The vendor may utilize the same format of TPCODL or on request SAFETY group will assist the vendor in developing the audit system. For other points also vendor may take the assistance of SAFETY group for development of Safety management system.

Doc. Title	GENERAL CONDITIONS OF CONTRACT - COMPOSITE WORKS	
Rev. No	0	Page 78 of 104

4: The vendor may submit the Safety Improvement Plan and Safety Action Plan for his employees based on following points.

- i. Action plan for enhancing safety awareness
- ii. Action plan for safety training of employee
- iii. Action plan for increasing safety audit in field
- iv. Action plan for provision and utilization of safety PPE.
- v. Action plan for fatality reduction.
- vi. Action plan for enhanced supervision at site
- vii. Action plan for making employee more responsible and accountable for safety.
- viii. Action plan for availability and utilization of all required tool and equipment.
- ix. Safety Improvement done in last two years, specially highlighting those which have been taken after the fatal accident along with results.
- x. Safety initiatives planed or started recently.
- xi. Any other point.

Based on above points and documentary evidences vendor will be required to submit a detailed report in support of his bid. The bid evaluation committee and competent authority will scrutinize the facts and the evidence submitted. If found satisfactory competent authority i.e. CTO may accord his approval for bid opening otherwise his tender shall be disqualified.

Doc. Title	GENERAL CONDITIONS OF CONTRACT - COMPOSITE WORKS	
Rev. No	0	Page 79 of 104

**Annexure 2 (Refer Para 3.2 and 5.8)**

***Risk Assessment Form***

Business Associate:
Scope of the work:
BA's Representative:
Telephone:
Signature:
Date:

Specific Task/Activity	Potential Hazards/Consequences	Class of Risk	Control Measures
Working at Height	Fall from height	2	<ol style="list-style-type: none"> <li>1. Mandatory usage of JSA checklist prior to start of work</li> <li>2. Use appropriate ladder</li> <li>3. Use full body safety harness having double lanyard.</li> <li>4. Use Electrical Safety Shoes if working on electrical network otherwise use safety shoes.</li> <li>5. Use Safety helmet.</li> <li>6. Use PPE as per the annexure 7 of this CSM document</li> <li>7. Refer Work instruction related to Working at Height for other details</li> <li>8. Use of metal scaffold to be ensured in height work (cup lock type)</li> <li>9. Deploy competent workforce who are medically fit</li> </ol>

Specific Task/Activity	Potential Hazards/Consequences	Class of Risk	Control Measures
Working on electrical equipment / network	Electric flash / electrocution	3	<ol style="list-style-type: none"> <li>1. Mandatory usage of JSA checklist prior to start of work</li> <li>2. Use Electrical Safety Shoes while working on electrical network.</li> <li>3. Use Electrical Safety gloves of appropriate voltage rating.</li> <li>4. Use face shield / visor attached with helmet.</li> <li>5. Use Safety helmet.</li> <li>6. Use PPE as per the annexure 7 of this CSM document</li> <li>7. Mandatory usage of Insulated tools &amp; tackles on electrical system</li> <li>8. Mandatory compliance for Lock Out &amp; Tag out system. Refer Work instruction related to Working on electrical equipment / network for other details</li> </ol>
Excavation / Civil work	Collapse of soil, Fall in excavated pit leading to Injury	2	<ol style="list-style-type: none"> <li>1. Use safety shoes.</li> <li>2. Use Safety helmet.</li> <li>3. Use PPE as per the annexure 7 of this CSM document</li> <li>4. Hard Barricading of the worksite.</li> <li>5. Refer Work instruction related to excavation / civil work for other details</li> </ol>
Material lifting & Mechanical Erection work	Fall of material/object, Topple of crane,	2	<ol style="list-style-type: none"> <li>1. Mandatory compliance of crane checklist</li> <li>2. Visual condition check of lifting tools and tackles such as wire rope sling, belt sling, chain, pulley block, D-shackles, etc. shall be ensured.</li> <li>3. The operator's physical fitness and alertness should be judged by sup. / EIC.</li> <li>4. Use PPE as per the annexure 7 of this CSM document</li> <li>5. Refer Work instruction related to Material lifting &amp; Mechanical Erection work</li> </ol>
Road Safety	Road Accidents	3	<ol style="list-style-type: none"> <li>1. Mandatory compliance of TPCODL Road Safety policy W07(COR-P-12)</li> </ol>

Doc. Title	GENERAL CONDITIONS OF CONTRACT - COMPOSITE WORKS	
Rev. No	0	Page 81 of 104

Specific Task/Activity	Potential Hazards/Consequences	Class of Risk	Control Measures
------------------------	--------------------------------	---------------	------------------

*Note: This information for the general indication purpose. The detailed risk assessment shall be conducted before start of the work by the authorized representative of the BA. The report of same shall be submitted to engineer in-charge along with annexure 4 of the CSM document.*

### Guidelines for filling the Risk Assessment Form

- *Specific Task/Activity* - The documentation of each major task associated with the contract.
- *Potential Hazards* - The identification of hazards associated with each activity or task to be carried out.
- *Class of Risk* - Each hazard should be evaluated as a level of risk, described as Risk Class 1, 2 or 3 defined above.
- *Control Measure* - The identification and documentation of actions required to eliminate or reduce the hazards that could lead to accident or injury.

Hazard / Risks shall be classified according to the following schedule:

- Class 1: Potential to cause injury treatable with first aid
- Class 2: Potential to cause death or permanent injury
- Class 3: Potential to cause more than one or more lost time injuries.

Doc. Title	GENERAL CONDITIONS OF CONTRACT - COMPOSITE WORKS	
Rev. No	0	Page 82 of 104

### **Annexure 3.1 (Refer Para 4.0)**

#### **General Safety Conditions for the Maintenance of Distribution Network Contracts:**

A BA awarded a contract (O&M) work of maintenance of distribution network will be required to fulfil the following conditions:

- BA shall provide Safety Policy and safety objectives of their company.
- BA shall comply with all statutory requirements like: applicable acts, regulations, codes of practice, OHSAS Standards, etc.
- BA shall provide the filled safety management questionnaire as per Annexure 1
- BA shall conduct a job risk assessment and provide information as per Annexure 2
- BA shall abide by Safety manuals, guidelines of TPCODL.
- BA shall provide its organisation structure & responsibilities in terms of Safety Management to TPCODL.
- BA shall document the work practices and procedures in terms of Safety Management.
- BA shall ensure safety training and induction program for the employees
- BA shall conduct safety audits & inspections as per TPCODL procedures provided by SAFETY group.
- BA shall provide and ensure the proper usage of the safety equipment (PPE) as per the TPCODL approved list in *annexure 7*.
- BA shall ensure periodic inspection of PPE to ensure its serviceability as per the specification given by TPCODL.
- BA shall ensure the adherence to standard operating procedures or guidelines laid down by TPCODL.
- BA shall ensure reporting of any unsafe act, unsafe conditions, near miss, incident or accident to engineer in-charge and SAFETY team of TPCODL.
- BA shall provide safety performance and Safety MIS (*annexure 9*) to engineer in-charge and SAFETY group periodically. Based on any non-confirmation to the safety procedures and guidelines, BA is liable to be negatively marked for his performance and suitable penalty will be imposed.
- BA shall ensure to depute a Safety Supervisor for managing a complete safety management system in a district. In case the BA has been awarded work in more than one district, then the following safety structure will be adopted.





Doc. Title	GENERAL CONDITIONS OF CONTRACT - COMPOSITE WORKS	
Rev. No	0	Page 83 of 104

**Annexure 3.2 (Refer Para 4.0)**

**General Safety Conditions for the Distribution Projects Major Contracts:**

A BA awarded a major contract work of TS&P in area of a circle will be required to fulfil the following conditions:

- BA shall provide Safety Policy and safety objectives of their company.
- BA shall comply with all statutory requirements like: applicable acts, regulations, codes of practice, OHSAS Standards, etc.
- BA shall provide the filled safety management questionnaire as per Annexure 1.
- BA shall conduct a job risk assessment and provide information as per Annexure 2
- BA shall abide by Safety manuals, guidelines of TPCODL.
- BA shall provide its organisation structure & responsibilities in terms of Safety Management to TPCODL.
- BA shall document the work practices and procedures in terms of Safety Management.
- BA shall ensure safety training and induction program for the employees
- BA shall conduct safety audits & inspections as per TPCODL procedures provided by SAFETY group.
- BA shall provide and ensure the proper usage of the safety equipment (PPE) as per the TPCODL approved list in annexure 7.
- BA shall ensure periodic inspection of PPE to ensure its serviceability as per the specification given by TPCODL.
- BA shall ensure the adherence to standard operating procedures or guidelines laid down by TPCODL.
- BA shall ensure reporting of any unsafe act, unsafe conditions, near miss, incident or accident to engineer in-charge and SAFETY team of TPCODL.
- BA shall provide safety performance and Safety MIS (*annexure 9*) to engineer in-charge and SAFETY group periodically. Based on any non-confirmation to the safety procedures and guidelines, BA is liable to be negatively marked for his performance and suitable penalty will be imposed.
- BA shall ensure to depute a Safety Supervisor for managing a complete safety management system in the area. In case the BA has been awarded work in more than one circle, then the following safety structure will be adopted.

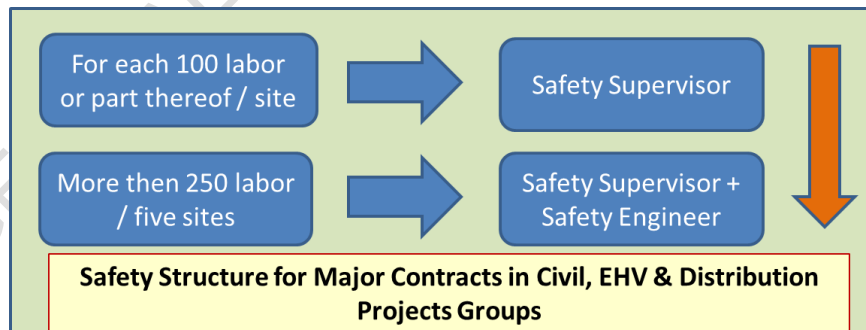

Doc. Title	GENERAL CONDITIONS OF CONTRACT - COMPOSITE WORKS	
Rev. No	0	Page 84 of 104

### Annexure 3.3 (Refer Para 4.0)

#### **General Safety Conditions for the major EHV Projects Contracts:**

A BA awarded a major contract work of EHV projects will be required to fulfil the following conditions:

- BA shall provide Safety Policy and safety objectives of their company.
- BA shall comply with all statutory requirements like: applicable acts, regulations, codes of practice, OHSAS Standards, etc.
- BA shall provide the filled safety management questionnaire as per Annexure 1
- BA shall conduct a job risk assessment and provide information as per Annexure 2
- BA shall abide by Safety manuals, guidelines of TPCODL.
- BA shall provide its organisation structure & responsibilities in terms of Safety Management to TPCODL.
- BA shall document the work practices and procedures in terms of Safety Management.
- BA shall ensure safety training and induction program for the employees
- BA shall conduct safety audits & inspections as per TPCODL procedures provided by SAFETY group.
- BA shall provide and ensure the proper usage of the safety equipment (PPE) as per the TPCODL approved list in annexure 7.
- BA shall ensure periodic inspection of PPE to ensure its serviceability as per the specification given by TPCODL.
- BA shall ensure the adherence to standard operating procedures or guidelines laid down by TPCODL.
- BA shall ensure reporting of any unsafe act, unsafe conditions, near miss, incident or accident to engineer in-charge and SAFETY team of TPCODL.
- BA shall provide safety performance and Safety MIS (*annexure 9*) to engineer in-charge and SAFETY group periodically. Based on any non-confirmation to the safety procedures and guidelines, BA is liable to be negatively marked for his performance and suitable penalty will be imposed.
- BA shall ensure to depute a Safety Supervisor for managing a complete safety management system in the area. In case the BA has been awarded work in more than one circle, then the following safety structure will be adopted.
- BA shall refer Construction Safety Manual in TPCODL Safety Manual for details.

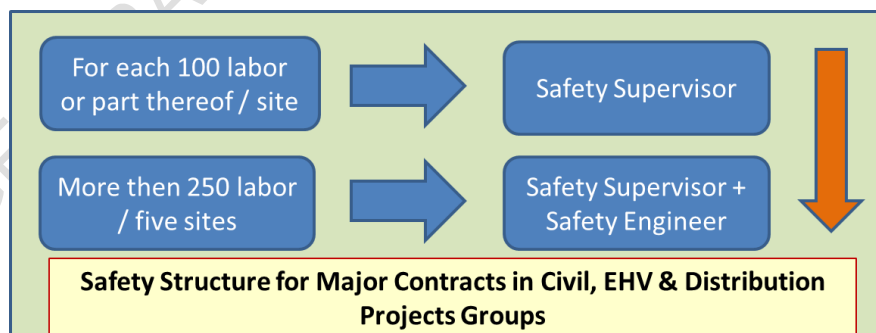

Doc. Title	GENERAL CONDITIONS OF CONTRACT - COMPOSITE WORKS	
Rev. No	0	Page 85 of 104

### Annexure 3.4 (Refer Para 4.0)

#### **General Safety Conditions for the Maintenance of Sub – Transmission Network Contracts:**

A BA awarded a major contract work of maintenance of sub – transmission network in area of a power system will be required to fulfil the following conditions:

- BA shall provide Safety Policy and safety objectives of their company.
- BA shall comply with all statutory requirements like: applicable acts, regulations, codes of practice, OHSAS Standards, etc.
- BA shall provide the filled safety management questionnaire as per Annexure 1
- BA shall conduct a job risk assessment and provide information as per Annexure 2
- BA shall abide by Safety manuals, guidelines of TPCODL.
- BA shall provide its organisation structure & responsibilities in terms of Safety Management to TPCODL.
- BA shall document the work practices and procedures in terms of Safety Management.
- BA shall ensure safety training and induction program for the employees
- BA shall conduct safety audits & inspections as per TPCODL procedures provided by SAFETY group.
- BA shall provide and ensure the proper usage of the safety equipment (PPE) as per the TPCODL approved list in annexure 7.
- BA shall ensure periodic inspection of PPE to ensure its serviceability as per the specification given by TPCODL.
- BA shall ensure the adherence to standard operating procedures or guidelines laid down by TPCODL.
- BA shall ensure reporting of any unsafe act, unsafe conditions, near miss, incident or accident to engineer in-charge and SAFETY team of TPCODL.
- BA shall provide safety performance and Safety MIS (*annexure 9*) to engineer in-charge and SAFETY group periodically. Based on any non-confirmation to the safety procedures and guidelines, BA is liable to be negatively marked for his performance and suitable penalty will be imposed.
- BA shall ensure to depute a Safety Coordinator for managing a complete safety management system in the area. In case the BA has been awarded work in more than one area power system, then the following safety structure will be adopted.



Doc. Title	GENERAL CONDITIONS OF CONTRACT - COMPOSITE WORKS	
Rev. No	0	Page 86 of 104

### Annexure 3.5 (Refer Para 4.0)

#### **General Safety Conditions for the major contract work in Civil / Generation Projects:**

A BA awarded a major contract work of / in civil or Generation project will be required to fulfil the following safety conditions:

- BA shall provide Safety Policy and safety objectives of their company.
- BA shall comply with all statutory requirements like: applicable acts, regulations, codes of practice, OHSAS Standards, etc.
- BA shall provide the filled safety management questionnaire as per Annexure 1
- BA shall conduct a job risk assessment and provide information as per Annexure 2
- BA shall abide by Safety manuals, guidelines of TPCODL.
- BA shall provide its organisation structure & responsibilities in terms of Safety Management to TPCODL.
- BA shall document the work practices and procedures in terms of Safety Management.
- BA shall ensure safety training and induction program for the employees
- BA shall conduct safety audits & inspections as per TPCODL procedures provided by SAFETY group.
- BA shall provide and ensure the proper usage of the safety equipment (PPE) as per the TPCODL approved list in annexure 7.
- BA shall ensure periodic inspection of PPE to ensure its serviceability as per the specification given by TPCODL.
- BA shall ensure the adherence to standard operating procedures or guidelines laid down by TPCODL.
- BA shall ensure reporting of any unsafe act, unsafe conditions, near miss, incident or accident to engineer in-charge and SAFETY team of TPCODL.
- BA shall provide safety performance and Safety MIS (*annexure 9*) to engineer in-charge and SAFETY group periodically. Based on any non-confirmation to the safety procedures and guidelines, BA is liable to be negatively marked for his performance and suitable penalty will be imposed.
- BA shall ensure to depute a Safety Supervisor (for workforce upto 100 at site) / a safety engineer (for workforce upto 250 at site) / safety manager (for more than two safety engineers) for managing a complete safety management system at the project site. In case the BA has been awarded more than one major contracts, then the following safety structure will be adopted.
- BA shall refer Construction Safety Manual in TPCODL Safety Manual for details.



Doc. Title	GENERAL CONDITIONS OF CONTRACT - COMPOSITE WORKS	
Rev. No	0	Page 87 of 104

**Annexure 3.6 (Refer Para 4.0)**

**General Safety Conditions for the major contract work in Commercial Department like - MMG, RRG, EAG, etc.:**

A BA awarded a major contract work in meter management group & energy auditing group will be required to fulfil the following safety conditions:

- BA shall provide Safety Policy and safety objectives of their company.
- BA shall comply with all statutory requirements like: applicable acts, regulations, codes of practice, OHSAS Standards, etc.
- BA shall provide the filled safety management questionnaire as per Annexure 1
- BA shall conduct a job risk assessment and provide information as per Annexure 2
- BA shall abide by Safety manuals, guidelines of TPCODL.
- BA shall provide its organisation structure & responsibilities in terms of Safety Management to TPCODL.
- BA shall document the work practices and procedures in terms of Safety Management.
- BA shall ensure safety training and induction program for the employees
- BA shall conduct safety audits & inspections as per TPCODL procedures provided by SAFETY group.
- BA shall provide and ensure the proper usage of the safety equipment (PPE) as per the TPCODL approved list in annexure 7.
- BA shall ensure periodic inspection of PPE to ensure its serviceability as per the specification given by TPCODL.
- BA shall ensure the adherence to standard operating procedures or guidelines laid down by TPCODL.
- BA shall ensure reporting of any unsafe act, unsafe conditions, near miss, incident or accident to engineer in-charge and SAFETY team of TPCODL.
- BA shall provide safety performance and Safety MIS (*annexure 9*) to engineer in-charge and SAFETY group periodically. Based on any non-confirmation to the safety procedures and guidelines, BA is liable to be negatively marked for his performance and suitable penalty will be imposed.
- BA shall ensure to depute a Safety Supervisor for managing a complete safety management system for the work as per the following safety structure.
- The BA for the RRG work shall depute one Safety supervisor.

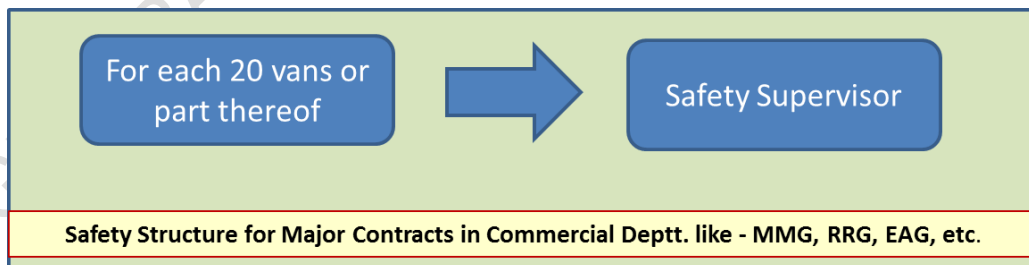

Doc. Title	GENERAL CONDITIONS OF CONTRACT - COMPOSITE WORKS	
Rev. No	0	Page 88 of 104

### **Annexure 3.7 (Refer Para 4.0)**

#### **General Safety Conditions for the major contract work in O&M of street light group:**

A BA awarded a major contract work in operation and maintenance of street light group will be required to fulfil the following safety conditions:

- BA shall provide Safety Policy and safety objectives of their company.
- BA shall comply with all statutory requirements like: applicable acts, regulations, codes of practice, OHSAS Standards, etc.
- BA shall provide the filled safety management questionnaire as per Annexure 1
- BA shall conduct a job risk assessment and provide information as per Annexure 2
- BA shall abide by Safety manuals, guidelines of TPCODL.
- BA shall provide its organisation structure & responsibilities in terms of Safety Management to TPCODL.
- BA shall document the work practices and procedures in terms of Safety Management.
- BA shall ensure safety training and induction program for the employees
- BA shall conduct safety audits & inspections as per TPCODL procedures provided by SAFETY group.
- BA shall provide and ensure the proper usage of the safety equipment PPE as per the TPCODL approved list in annexure 7.
- BA shall ensure periodic inspection of PPE to ensure its serviceability as per the specification given by TPCODL.
- BA shall ensure the adherence to standard operating procedures or guidelines laid down by TPCODL.
- BA shall ensure reporting of any unsafe act, unsafe conditions, near miss, incident or accident to engineer in-charge and SAFETY team of TPCODL.
- BA shall provide safety performance and Safety MIS (*annexure 9*) to engineer in-charge and SAFETY group periodically. Based on any non-confirmation to the safety procedures and guidelines, BA is liable to be negatively marked for his performance and suitable penalty will be imposed.
- Each BA shall ensure to depute a Safety Supervisor for managing a complete safety management system for the work awarded as per the below structure.



Doc. Title	GENERAL CONDITIONS OF CONTRACT - COMPOSITE WORKS	
Rev. No	0	Page 89 of 104

**Annexure 4 (Refer Para 3.3)**

**Safety Undertaking by way of Affidavit**

I \_\_\_\_\_ s/o \_\_\_\_\_ R/o \_\_\_\_\_ (AUTHORIZED REPRESENTATIVE/PARTNER/DIRECTOR/PROPRIETOR ) of M/S \_\_\_\_\_ (name of company/firm) having its office at (Complete address of Company), authorized vide power of attorney dated -----/Board resolution dated----/letter of authority dated----, hereinafter referred to as **Contractor [or Business Associate (BA)]** which expression shall, unless it be repugnant to or inconsistent with the meaning or context thereof, be deemed to include its heirs, executors, administrators, and assigns do hereby affirm and undertake as under :

1. The present undertaking shall remain in force from the date of execution of contract awarded by TPCODL and shall be valid till the date of termination of the said contract by either parties. The undertaking is binding on me (contractor) as well as my sub-contractor and its employees, representatives etc.
2. That I(the contractor) will be responsible and liable to comply and abide by all the safety rules, instructions and regulations as may be specified and laid down by The TP Central Odisha Distribution Limited (TPCODL) so as enable TPCODL to achieve its goal of Zero On site incidences.
3. That the Contractor shall be fully responsible for ensuring occupational health and safety of its employees, representatives, agents as well as of its subcontractor's employees, at all times during the discharge of their respective obligations under the contract including any methods adopted for performance of their tasks / work.
4. That Contractor shall ensure ,at its own expense to arrange for and procure, implement all requisite accident prevention tools, first aid boxes, personal protective equipment, fire extinguisher, safety training, Material Safety Data Sheet, pre-employment medical test, etc. for operations & activities including as & when so specified by TPCODL specifically. , failing which TPCODL shall be entitled, but not obliged, to provide the same and recover the actual cost thereof from the Contractor's payments.
5. That the Contractor shall engage adequate and competent Safety – Supervisor / Engineer / Manager / Skilled persons at site as per the Para 5 (Qualification and experience of safety personnel) and Annexure 3 of Contract Safety Management.
6. That the Contractor shall engage the competent Site – Supervisor with each group of workers for safe and correct workmanship, proper co-ordination of material and site work as per contract.

Doc. Title	GENERAL CONDITIONS OF CONTRACT - COMPOSITE WORKS	
Rev. No	0	Page 90 of 104

7. That the Contractor shall immediately replace supervisor in case it is found to be not up to the level of skill and experience required as in skill and experience required in *annexure 5* of this document, but any such replacement shall be only with the prior concurrence of TPCODL .
8. That the Contractor and its subcontractors shall abide by all the safety guidelines as per Safety Manual, Contract Safety Management and other guidelines issued from time to time by TPCODL during the contract period.
9. That in case the Contractor and/or any of its Subcontractor fail to ensure the compliance as required in terms of this undertaking the Contractor shall keep and hold TPCODL / its directors / officers / employees indemnified against any / all losses / damage / expense / liability / fines / compensation / claims / action / prosecutions or the like which might be suffered by TPCODL or to which TPCODL might get exposed to as a result of any breach /wilful negligence /deliberate default on the part of the Contractor /Subcontractor in complying with the same. Contractor shall also furnish any press release, clarification etc. if sought by TPCODL for any near miss or safety violations, accidents, which are attributable to fault of Contractor.

DEPONENT

VERIFICATION

Verified at Bhubaneswar on this      Day of      20     that the contents of the above affidavit are true and correct and nothing material has been concealed therefrom

DEPONENT



Doc. Title	GENERAL CONDITIONS OF CONTRACT - COMPOSITE WORKS	
Rev. No	0	Page 91 of 104

**Annexure 5 (Refer Para 5.4)**

**SKILL / QUALIFICATION REQUIRED FOR ELECTRICIAN AND ELECTRICAL SUPERVISOR**

**Skill / Qualifications Required for Electrician (*Certificate of Competency Class-II*):**

1. Formal education in ITI – Wireman/ Electrician trade.

OR

2. Working experience of minimum three years of practical wiring.

OR

3. Have completed three years apprenticeship course through Apprenticeship Advisor, Govt. of Odisha / other state Govt. in the trade of Lineman / Wireman / Electrician.
4. A candidate must have attained the age of Eighteen years.

**Skill / Qualifications Required for Electrical Supervisor (*Certificate of Competency Class-I*):**

1. Have at least five years' experience of practical wiring after passing the certificate of competency class-II i.e. electrician.

OR

2. Recognized Degree or Diploma or equivalent qualification in Electrical Engineering from any Technical institute / College or University recognized by the Board.

AND

Must have completed the training/job in rectifying the common defects in electrical line and power installation for a period of one and three years after passing Degree or Diploma respectively

OR

3. Possessing the valid certificate of certificate of competency class – 1 (Electrical Supervisor)

Doc. Title	GENERAL CONDITIONS OF CONTRACT - COMPOSITE WORKS	
Rev. No	0	Page 92 of 104

## **Annexure 6 (Refer Para 5.6)**

### **Training Module for BAs Worker & Supervisor**

#### **Training for BA Supervisor**

**Duration – 02 Hrs / Month**

**Methodology:** Lecture and Practical Demonstration of Safety Zone Creation

#### **Session: 1**

**Topic:** Electrical Safety Aspects

#### **Sub Topics:**

1. Learning specifics of HT & LT Network of zone
2. Major type of HT / LT / service lines / street light maintenance works
3. Understanding the need of Safety
4. Understanding the safe process of maintenance :
  - Planning of the maintenance job
  - Availability of men, material & machine, PPEs, Safety gear and approved PTW
  - Briefing of the job by the supervisor of the TPCODL
  - Identification of Risks associated with the maintenance work and planning for controlling measures by TPCODL supervisor
  - Creation of safety zone by TPCODL supervisor and satisfying that the network is dead – Use of Neon Tester, Shorting Chain and Safety Tagging
  - Start of the work – Right person for the right job
  - Alert supervision
  - Completion of the job – Check points
  - Energization of network
  - Actions to be taken in case of some accident

#### **Session: 2**

**Topic:** Use of Electrical Testing Equipment

**Methodology:** Lecture and Practical Demonstration

#### **Sub Topics:**

1. Meggar, Hi Pot, Clamp On Meter, Neon Tester, Discharge Rod, Line tester etc.

#### **Session: 3**

**Topic:** Awareness of Electrical Safety Aspects

- A. Understanding the need of this Training and Safety
- B. Learning specifics of HT & LT Network
- C. Major type of work to be carried out in zones
- D. Switching Operations (Do's & Don'ts) including Street Light Switching
- E. Working on Height (*practical demo also*)
- F. Understanding the Safe Process of Maintenance / Working:
  - Planning of the job
  - Availability of men, material & machine, PPEs, Safety gear and approved PTW
  - Briefing of the job by the supervisor
  - Permit to Work
  - Safety Tagging and Lock Out Tag out

Doc. Title	GENERAL CONDITIONS OF CONTRACT - COMPOSITE WORKS	
Rev. No	0	Page 93 of 104

- Identification of Risks associated with the work to be carried out and planning for controlling measures by proper supervision
- Concept of "**Safety Zone**"
- Identification and use of Neon Tester, Shorting Chain, Clamp On Meter, Hi Pot, Meggar etc.
- Completion of the job – Check points
- Accident Theory & Incident Reporting
- Actions to be taken in case of some accident

#### **Session: 4**

**Topic: Identification, Demonstration and Usages of Tools, PPEs and other Safety Gears and demonstration of working on HT pole**

#### **Session: 5**

**Topic: Practical demonstration of Safety Zone creation**

### **FREQUENCY**

#### **Regular Safety Training Program**

- It will be conducted for all field & supervisor staff of BA in such a manner that all BA Personnel attend at least two hours safety training during every month.

#### **One Day Induction Safety Training Programs:**

- This training will be for the new BA's personnel, who have been cleared by the Cross Functional Panel to undergo Safety training and who are likely to be deployed at various work sites of TPCODL by the BA, as a part of AMC / Work Contract.

#### **Duration / Periodicity:**

- Duration and periodicity has been defined above. However, this is subject to change at the discretion of TPCODL.

Doc. Title	GENERAL CONDITIONS OF CONTRACT - COMPOSITE WORKS	
Rev. No	0	Page 94 of 104

**Annexure 7 (Refer Para 5.7)**



**LIST OF PERSONAL PROTECTIVE EQUIPMENT AND TESTING FREQUENCY**

Sl. No.	Name of PPE	IS / EN Standard	Testing Frequency	Remarks	Ref Brand & Model
01	Leather Safety Shoes (Color – Black) with PU toe cap.	IS:15298 (Part-2)	Monthly and visual check every day for any crack or damage in the leather or sole.		BATA (Model No.- Endura L/C)  Liberty (Model No. – 7198-01 HT Barton Black – Warrior)
02	HDPE Safety helmet with chin strap and ratchet type for adjustment.	IS:2925-1984	Monthly and visual check every day for any crack in shell.		Karam (PN Safetech )  Joseph Leslie  Accent Industries  Honeywell
03	Full body harness (Safety belt)	EN 361	Monthly and visual check every day of the bends and the harness.		Karam (PN Safetech )  Joseph Leslie  Accent Industries
04	Electrical Safety Gloves	EN: 60903 CE marked	Weekly and visual check for any crack and blow test before every work.	Manufactured not beyond 12 months.	Make Sparian / Sumitech / CATU supplied with inner cotton glove with over glove of split leather.
05	Full face visor with safety helmet	EN: 166 CE marked (Visor)	Monthly and visual check every day for any crack in shell.	Clear acrylic visor attached with safety helmet.	Karam (PN Safetech )  Joseph Leslie  Accent Industries  Honeywell
06	Fire Proof jacket for chest protection		Monthly and visual check every day.		
07	Safety Chain for shorting cum earthing.	As per TPCODL standard	Weekly and visual check before every work.	Made of brass, Total length – 5.5 meters and made of 12 SWG.	

*Note:*

1. Any other Personal Protection Equipment required beyond above list will be according to BIS or EN Standards.
2. All Personal Protection Equipment will be checked by the engineer in-charge or SAFETY group of TPCODL.
3. Safety Representative of the BA has to maintain the record of the availability, condition and checking of the PPEs.
4. All tools required as per the contract must be according to respective IS / EN standards.
5. TPCODL may revise or add the above list of PPE and their specifications as and when feel necessary. The information about new specifications /models will be circulated by the Engineer In-charge (EIC), which shall adhere by the business associated in the shortest possible time. The EIC shall issue a memo / instruction to BA with timeline for implementation. Any delay will be treated as non- compliance / safety violations. Refer picture of each PPE given in next page.

**Pictures of PPE for reference purpose.**

Sl. No.	Name of PPE	IS / EN Standard	Picture
01	Leather Safety Shoes (Color – Black) with PU toe cap.	IS:15298(Part-2) and with test report of electrical resistance.	
02	HDPE Safety helmet with chin strap and ratchet type for adjustment.	IS:2925-1984	
03	Full body harness (Safety belt)  The straps at shoulder and thigh shall have full pad for comfort. The back shall be so designed that harness straps do not tangle with each other.	EN 361:2002 EN 358 : 2000 IS: 3521:1991/2002	

04	Electrical Safety Gloves – Composite type Soft electrical gloves as per size of individual.	EN: 60903 CE marked	
05	Full face visor with safety helmet	EN: 166 CE marked (Visor)	
06	Fire Proof jacket for chest protection		
07	Safety Chain for shorting cum earthing.	As per TPCODL standard	
08	Reflective jacket to each workmen	As per TPCODL standard	

Note : Picture shown are for indicative purpose only. Actual product may differ.

**Annexure 8 (Refer Para 5.8) LIST OF AUDITS TO BE CONDUCTED**

Audits	Responsibility	Freq.	Ref. Doc.
Permit to Work & Field Audit	BA Safety Representative	Weekly	F04 (COR P - 12)
Tool Bag & PPE's Audit		Weekly	F06 (COR P - 12)
First Aid Box Maintenance Record		Fortnightly	F08 (COR P - 12)
Fire Extinguisher Record <i>(Applicable for the BA involved in major construction works and have storage of flammable material at worksite)</i>		Monthly	F09 (COR P - 12)
Safety Talk Register		Weekly	F18 (COR P - 12)
Site Safety Audit		Daily	F29A (COR P - 12)

Note:

1. (BA Safety Representative has to use the formats as per Safety process COR – P – 12 of TPCODL)

Doc. Title	GENERAL CONDITIONS OF CONTRACT - COMPOSITE WORKS	
Rev. No	0	Page 98 of 104

**Annexure 9 (Refer Para 5.9)**

**PERFORMANCE REPORT – SAFETY**

**FOR THE MONTH OF.....**

Name of BA : .....

Name of the Project and Purchase order No: .....

Date of commencement of work: .....

Man Hour Worked in this month (No. of employees X 8 Hrs + Overtime): .....

Cumulative Man Hour worked: .....

Total Number of Minor Injury (this month): ..... Minor Injury (Total).....

Major Injury (this month): ..... Major Injury (Total): .....

Detail of the Incident / Sub Standard Acts and Condition

Activity	This Month	Cumulative (Total)	Day Lost (this month)	Days Lost (Cumulative)
No. of the Incident				
No. of lost time injuries				
No. of dangerous occurrences				
No. of near miss reported				
Substandard Act/Conditions observed			Attach details of observation of this month	
Safety Violation Notice received (from TPCODL) (both in numbers and in Rs.)	No.	No.	No. of violation letter received and compliance report for the TPCODL.	
	Rs.	Rs.		

*Note: Cumulative means total from date of commencement of work according to the contract.*

Detail of the Accident / Near Miss Incidents:

Date and Time	Type of the incident	Name of Employee	Brief Description	Corrective and Preventive actions recommended

Details of the Safety Violations:



Doc. Title	<b>GENERAL CONDITIONS OF CONTRACT - COMPOSITE WORKS</b>	
Rev. No	0	Page 99 of 104

Date and Location	Brief Description	Name of employee involved	Action Taken

Detail of the Safety Talk / Tool Box Talk / Safety Training

Date and Location	Topic (s)	Total Number of employees (Worker / Supervisor)	Number of participants (Worker / Supervisor)

Detail of the Safety Meeting

Date and Location	Number of participants	Topics discussed	Major Observations / Innovation

Detail of the Safety Inspection /Audit: (as per TPCODL site audit checklist F29A(COR-P-12))

Date	Area / Location	Major Observations	Recommendations	Action Taken

Any other Safety, Occupational Health, Environment & Disaster Management Promotional Activity (During this month):

Date	Location	Activity	Level of Participation	Number of participation

Signature of the BA Safety Representative  
HoG

Signature of ZM /

Name, E. No. and Date

Name, E. No. Date.

*Note: The original form to be deposited with Engineer in-charge and a copy to SAFETY group on or before 5<sup>th</sup> of every month along with bill. List of training of the current month and status of PPE to be also mentioned individual wise.*

*BA may include additional lines if required. The TPCODL may revise the format as and when deemed required.*

Doc. Title	GENERAL CONDITIONS OF CONTRACT - COMPOSITE WORKS	
Rev. No	0	Page 100 of 104

**ANNEXURE-M**  
**VENDOR APPRAISAL FORM**

<b>TO BE SUBMITTED BY VENDOR (To be filled as applicable)</b>			
<b>VENDOR:</b>			
<b>1.0</b>	<b>DETAILS OF THE FIRM</b>		
	1.1	NAME (IN CAPITAL LETTERS)	:
	1.2	TYPE OF CONCERN (PROPRIETARY) Partnership, Pvt. Ltd., Public Ltd. etc.	:
	1.3	YEAR OF ESTABLISHMENT	:
	1.4	LOCATION OF OFFICE POSTAL ADDRESS TELEGRAPHIC ADDRESSES, TELEX NO. FAX NO.	:
	1.5	LOCATION OF MANUFACTURING UNITS	:
		i) UNITS 1	:
		ii) OTHER UNITS	:
<b>2.0</b>	<b>PRODUCTS MANUFACTURED</b>		
<b>3.0</b>	<b>TURNOVER DURING THE LAST 3 YEARS (TO BE VERIFIED WITH THE LATEST PROFIT &amp; LOSS STATEMENT).</b>		
<b>4.0</b>	<b>VALUE OF FIXED ASSETS</b>		
<b>5.0</b>	<b>NAME &amp; ADDRESS OF THE BANKERS</b>		
<b>6.0</b>	<b>BANK GUARANTEE LIMIT</b>		
<b>7.0</b>	<b>CREDIT LIMIT</b>		
<b>8.0</b>	<b>TECHNICAL</b>		
	8.1	NO.OF DESIGN ENGINEERS (INDICATE NO.OF YEARS EXPERIENCE IN RELATED FIELDS)	:
	8.2	NO.OF DRAUGHTSMEN	:
	8.3	COLLABORATION DETAILS (IF ANY)	:
		8.3.1 DATE OF COLLABORATION	:
		8.3.2 NAME OF COLLABORATOR	:

Doc. Title	GENERAL CONDITIONS OF CONTRACT - COMPOSITE WORKS	
Rev. No	0	Page 101 of 104

		8.3.3 RBI APPROVAL DETAILS	:
		8.3.4 EXPERIENCE LIST OF COLLABORATOR	:
		8.3.5 DURATION OF AGREEMENT	:
	8.4	AVAILABILITY OF STANDARDS / DESIGN PROCEDURES / COLLABORATOR'S / DOCUMENTS (CHECK WHETHER THESE ARE LATEST/CURRENT)	:
	8.5	TECHNICAL SUPPORT, BACK-UP GUARANTEE, SUPERVISION, QUALITY CONTROL BY COLLABORATOR (WHEREVER ESSENTIAL). (THIS CLAUSE IS RELEVANT WHEN VENDOR'S EXPERIENCE IS INADEQUATE)	:
	8.6	QUALITY OF DRAWINGS	:
<b>9.0</b>	<b>MANUFACTURE</b>		
	9.1	SHOP SPACE, LAYOUT LIGHTING, VENTILATION, ETC.	:
	9.2	POWER (KVA)	:
		MAINS INSTALLED	:
		UTILISED	:
		STANDBY POWER SOURCE	:
	9.3	MANUFACTURING FACILITIES (ATTACH LIST OF EQUIPMENT AS APPLICABLE)	:
		9.3.1 MATERIAL HANDLING	:
		9.3.2 MACHINING	:
		9.3.3 FABRICATION	:
		9.3.4 HEAT TREATMENT	:
		9.3.5 BALANCING FACILITY	:
		9.3.6 SURFACE TREATMENT PRIOR TO PAINTING/ COATING, POLISHING, PICKLING, PASSIVATION, PAINTING, ETC.	:
	9.4	SUPERVISORY STAFF	:
	9.5	ADEQUACY OF SKILLED LABOURS (MACHINISTS, WELDERS, ETC.)	:
	9.6	NO. OF SHIFTS	:
	9.7	TYPE OF MATERIAL HANDLED (SUCH AS CS, SS, ETC.)	:

Doc. Title	<b>GENERAL CONDITIONS OF CONTRACT - COMPOSITE WORKS</b>	
Rev. No	0	Page 102 of 104

	9.8	WORKMANSHIP	:
	9.9	MATERIAL IN STOCK AND VALUE	:
	9.10	TRANSPORT FACILITIES	:
	9.11	CARE IN HANDLING	:
<b>10.0</b>	<b>INSPECTION / QC / QA / TESTING</b>		
	10.1	NUMBER OF PERSONNEL (INDICATE NO.OF YEARS OF EXPERIENCE)	:
	10.2	INDEPENDENCE FROM PRODUCTION	:
	10.3	AVAILABILITY OF PROCEDURAL WRITE UP/QUALITY PLAN	:
	10.4	INCOMING MATERIAL CONTROL AND DOCUMENTATION	:
	10.5	RELIABILITY/REPUTATION OF SUPPLY SOURCES	:
	10.6	STAGE INSPECTION AND DOCUMENTATION	:
	10.7	SUB-ASSEMBLY & DOCUMENTATION	:
	10.8	FINAL INSPECTION AND DOCUMENTATION	:
	10.9	PREPARATION OF FINAL DOCUMENTATION PACKAGE	:
	10.10	TYPE TEST FACILITIES	:
	10.11	ACCEPTANCE TEST FACILITIES	:
	10.12	CALIBRATION OF INSTRUMENTS AND GAUGES (WITH TRACEABILITY TO NATIONAL STANDARDS) (ATTACH LIST)	:
	10.13	STATUTORY APPROVALS LIKE BIS, IBR, ETC.(AS APPLICABLE)	:
	10.14	SUB-VENDOR APPROVAL SYSTEM AND QUALITY CONTROL	:
	10.15	DETAILS OF TESTS CARRIED OUT AT INDEPENDENT RECOGNISED LABORATORIES	:
		i) FURNISH LIST OF TESTS CARRIED OUT AND THE NAME OF THE LABORATORY WHERE THE TESTS WERE CONDUCTED	:
		ii) CHECK AVAILABILITY OF CERTIFICATES AND REVIEW THESE WHEREVER POSSIBLE	:
<b>11.0</b>	<b>EXPERIENCE (INCLUDING CONSTRUCTION / ERECTION / COMMISSIONING) TO BE FURNISHED IN THE FORMAT INDICATED IN APPENDIX)</b>		
<b>12.0</b>	<b>SALES, SERVICE AND SITE ORANISATIONAL DETAILS</b>		

Doc. Title	GENERAL CONDITIONS OF CONTRACT - COMPOSITE WORKS	
Rev. No	0	Page 103 of 104

13.0	<b>CERTIFICATE FROM CUSTOMERS (ATTACH COPIES OF DOCUMENTS)</b>	:
14.0	<b>POWER SITUATION</b>	:
15.0	<b>LABOUR SITUATION</b>	:
16.0 *	<b>APPLICABILITY OF SC/ST RELAXATION (Y/N) IF YES, SUPPORTING DOCUMENTS TO BE ATTACHED</b>	
17.0	<b>ORGANIZATIONAL DETAILS</b> 1. PF NO 2. ESI NO 3. INSURANCE FOR WORK MAN COMPENSATION ACT NO 4. ELECTRICAL CONTRACT LIC NO 5. ITCC / PAN NO 6. SALES TAX NO 7. WC TAX REG. NO	:
18.0	<b>DOCUMENTS TO BE ENCLOSED:</b> 1. FACTORY LICENSE 2. ANNUAL REPORT FOR LAST THREE YEARS 3. TYPE TEST REPORT FOR THE ITEM 4. PAST EXPERIENCE REPORTS 5. ISO CERTIFICATE –QMS, EMS, OHAS, SA 6. REGISTRATION OF SALES TAX 7. COPY OF TIN NO. 8. COPY OF SERVICE TAX NO. 9. REGISTRATION OF CENTRAL EXCISE 10. COPY OF INCOME TAX CLEARANCE. 11. COPY OF PF REGISTRATION 12. COPY OF ESI REGISTRATION 13. COPY OF INSURANCE FOR WORK MAN COMPENSATION ACT NO 14. COPY OF ELECTRICAL CONTRACT LIC NO 15. COPY OF PAN NO 16. COPY OF WC TAX REGISTRATION 17. DOCUMENTS IN SUPPORT OF SC/ST RELAXATION AT S.NO.16.0 18. GST Registration No	

\* **Classification of BA s under SC/ST shall be governed under following guidelines:**

- **Proprietorship/ Single Ownership Firm:** Proprietor of the firm should be from SC/ST community. Governing document shall be Proprietorship Deed.
- **Partnership Firm:** Only such firms shall qualify which have SC/ST partners holding equal to or more than 50% of the total ownership pattern of the firm. Governing document shall be Partnership Deed.
- **Private Limited Company:** Only such firms shall qualify which have SC/ST directors holding equal to or more than 50% of the total ownership pattern of the firm. Governing document shall be Memorandum of Understanding (MoU) and/or Article of Association (AoA).

**NOTE: Certification from SC/ST Commission shall be required for deciding upon SC/ST status of a person.**

Doc. Title	GENERAL CONDITIONS OF CONTRACT - COMPOSITE WORKS	
Rev. No	0	Page 104 of 104

**ANNEXURE-N**  
**MANUFACTURER AUTHORIZATION FORM**

*(To be submitted on OEM's Letter Head)*

Date: .....

Tender Enquiry No.: .....

To,

Chief (Procurement & Stores)

TP Central Odisha Distribution Limited,  
Bhubaneswar

Sir,

WHEREAS M/s. *[name of OEM]*, who are official manufacturers of ..... having factories at *[address of OEM]* do hereby authorize M/s *[name of bidder]* to submit a Bid in relation to the Invitation for Bids indicated above, the purpose of which is to provide the following Goods, manufactured by us

.....

and to subsequently negotiate and sign the Contract.

We hereby extend our full guarantee and warranty in accordance with the Special Conditions of Contract or as mentioned elsewhere in the Tender Document, with respect to the Goods offered by the above firm in reply to this Invitation for Bids.

We hereby confirm that in case, the channel partner fails to provide the necessary services as per the Tender Document referred above, M/s *[name of OEM]* shall provide standard warranty on the materials supplied against the contract. The warranty period and inclusion / exclusion of parts in the warranty shall remain same as defined in the contract issued to their channel partner against this tender enquiry.

Yours Sincerely,

For .....

Authorized Signatory

<b>TPCODL</b>	<b>TP CENTRAL ODISHA DISTRIBUTION LIMITED</b>	
	<b>WORK INSTRUCTION /OPERATING GUIDELINES</b>	
Doc. Title	<b>GENERAL CONDITIONS OF CONTRACT- COMPOSITE ORDERS</b>	
Rev. No	0	Page 1 of 104

<b>CONTENTS</b>	
<b>CLAUSE NO.</b>	<b>DESCRIPTION</b>
<b>1.0</b>	<b>ORGANIZATIONAL VALUES</b>
<b>2.0</b>	<b>ETHICS</b>
<b>3.0</b>	<b>CONTRACT PARAMETERS</b>
3.1	Issue/ Award of Contract
3.2	Contract Commencement Date
3.3	Contract Completion Date
3.4	Contract Period/Time
3.5	Contract Execution Completion Date
3.6	Contract Execution Period/Time
3.7	Contract Price /Value
3.8	Contract Document
3.9	Contract Language
3.10	Reverse Auction
<b>4.0</b>	<b>SCOPE OF WORK</b>
4.1	Technical Evaluation
4.2	Indemnity
4.3	Display of notice boards at work site
4.4	Disposal of waste at site
4.5	Deployment of workforce
4.6	Damage of Properties
4.7	Issuance of material
4.8	Company's right to use works
4.9	Rights of TPCODL to vary the scope work
<b>5.0</b>	<b>PRICES/RATES/TAXES</b>
5.1	For Supply part of Contract
5.2	For Service part of Contract
5.3	Changes in statutory Tax Structure

Doc. Title	<b>GENERAL CONDITIONS OF CONTRACT - COMPOSITE WORKS</b>	
Rev. No	0	Page 2 of 104

<b>CONTENTS</b>	
<b>CLAUSE NO.</b>	<b>DESCRIPTION</b>
<b>6.0</b>	<b>TERMS OF PAYMENT</b>
6.1	Pre-Requisites for Payment
6.2	Bills & Invoices
6.3	Payment & Statutory Deductions
6.4	Guidelines for Raising Running/Final Bills
6.5	Quantity Variation
6.6	Full and Final Payment
<b>7.0</b>	<b>MODE OF PAYMENT</b>
<b>8.0</b>	<b>SECURITY CUM PERFORMANCE DEPOSIT</b>
<b>9.0</b>	<b>STATUTORY COMPLIANCE</b>
9.1	Compliance to Various Acts
9.2	SA 8000
9.3	Affirmative Action
9.4	Compliance to Labour Laws
9.5	Compliance to C&D Waste Management Rules & Environment (Protection) Amendment Rules
<b>10.0</b>	<b>QUALITY</b>
10.1	Knowledge of Requirements
10.2	Material/Equipment/Works Quality
10.3	Adherence to Rules & Regulations
10.4	Specifications and Standards
<b>11.0</b>	<b>SAFETY</b>
<b>12.0</b>	<b>INSPECTION/PARTICIPATION</b>
12.1	Right to Carry Out Inspection
12.2	Facilitating Inspection
12.3	Third Party Nomination
12.4	Waiver of Inspections
12.5	Incorrect Inspection Call
<b>13.0</b>	<b>MDCC &amp; DELIVERY OF MATERIALS</b>
13.1	Material Dispatch Clearance Certificate



Doc. Title	<b>GENERAL CONDITIONS OF CONTRACT - COMPOSITE WORKS</b>	
Rev. No	0	Page 3 of 104

<b>CONTENTS</b>	
<b>CLAUSE NO.</b>	<b>DESCRIPTION</b>
13.2	Right to Rejection on Receipt
13.3	Consignee
13.4	Submission of Mandatory Documents on delivery
13.5	Dispatch and Delivery Instructions
<b>14.0</b>	<b>GUARANTEE</b>
14.1	Guarantee of Performance
14.2	Guarantee period
14.3	Failure in Guarantee period (GP)
14.4	Cost of repairs on failure in GP
14.5	Guarantee Period for Goods Outsourced
14.6	Latent Defect
14.7	Support beyond the Guarantee Period
<b>15.0</b>	<b>LIQUIDATED DAMAGES</b>
15.1	LD Waiver Request
15.2	Material Recovery
<b>16.0</b>	<b>ASSIGNMENT OR SUBCONTRACTING</b>
<b>17.0</b>	<b>UNLAWFUL ACTIVITIES</b>
<b>18.0</b>	<b>CONFIDENTIALITY</b>
18.1	Documents
18.2	Geographical Data
18.3	Associate's Processes
18.4	Exclusions
18.5	Violation
<b>19</b>	<b>INTELLECTUAL PROPERTY RIGHTS</b>
<b>20</b>	<b>INDEMNITY</b>
<b>21</b>	<b>LIABILITY &amp; LIMITATIONS</b>
21.1	Liability
21.2	Limitation of Liability
<b>22.0</b>	<b>FORCE MAJEURE</b>

Doc. Title	<b>GENERAL CONDITIONS OF CONTRACT - COMPOSITE WORKS</b>	
Rev. No	0	Page 4 of 104

<b>CONTENTS</b>	
<b>CLAUSE NO.</b>	<b>DESCRIPTION</b>
<b>23.0</b>	<b>SUSPENSION OF CONTRACT</b>
23.1	Suspension for Convenience
23.2	Suspension for Breach of Contract Conditions
23.3	Compensation in lieu of Suspension
<b>24.0</b>	<b>TERMINATION OF CONTRACTS</b>
24.1	Termination for default/breach of contract
24.2	Termination for convenience of associate
24.3	Termination for Convenience of TPCODL
<b>25.0</b>	<b>Dispute resolution and Arbitration</b>
25.1	Governing laws and jurisdiction
<b>26.0</b>	<b>ATTRIBUTES OF GCC</b>
26.1	Cancellation
26.2	Severability
26.3	Order of Priority
<b>27.0</b>	<b>INSURANCE</b>
<b>28.0</b>	<b>ERRORS AND OMISSIONS</b>
<b>29.0</b>	<b>TRANSFER OF TITLES</b>
<b>30.0</b>	<b>SUGGESTIONS &amp; FEEDBACK</b>
<b>31.0</b>	<b>CONTACT POINTS</b>
<b>32.0</b>	<b>LIST OF ANNEXURES</b>

Doc. Title	GENERAL CONDITIONS OF CONTRACT - COMPOSITE WORKS	
Rev. No	0	Page 5 of 104

## 1.0 ORGANIZATIONAL VALUES

The Tata Group has always been a value driven organization. These values continue to direct the Group's growth and businesses. The Six core Tata Values underpinning the way we do business are:

**Integrity** - We must conduct our business fairly, with honesty and transparency. Everything we do must stand the test of public scrutiny.

**Understanding** - We must be caring, respectful, compassionate and humanitarian towards our colleagues and customers around the world and always work for the benefit of India.

**Excellence** - We must constantly strive to achieve the highest possible standards in our day to day work and in the quality of goods and services we provide.

**Unity** - We must work cohesively with our colleagues across the group and with our customers and partners around the world to build strong relationships based on tolerance, understanding and mutual co-operation.

**Responsibility** - We must continue to be responsible and sensitive to the countries, communities and environments in which we work, always ensuring that what comes from the people goes back to the people many times over.

**Agility** - We must work in a speedy and responsive manner and be proactive and innovative in our approach.

## 2.0 ETHICS

In our effort towards Excellence and in Management of Business Ethics at TPCODL, an Ethics Management Team is constituted.

The main objective of the Ethics Management Team is to:

1. Record, address and allay the issues and concerns on ethics raised by different stakeholders like employees, consumers, vendors, Associates etc. by initiating immediate corrective actions.
2. Ensure proper communication of the ethics policies and guidelines through prominent displays at all offices of TPCODL and through printed declarations in all concerned documents where external stakeholders are involved.
3. Ensure proper framework of policies as preventive measures against any ethics violation recorded by them.
4. Prepare and submit MIS of all issues and concerns, corrective and preventive actions on monthly basis to the top management for their information.

All members of Team TPCODL, Associates and Stakeholders are requested to register any grievance on ethics violation on Central Control Telephone No. 011-66404040.

## 3.0 CONTRACT PARAMETERS

### 3.1 Issue/Award of Contract

TPCODL awards the contract to the Associate in writing in the form of Purchase order or Rate Contract (RC) hereafter referred as Contract, through in any or all of following modes- physical handover / post / e-mail / web document / fax with all the attachments/enclosures which shall be part of the contract document

Doc. Title	GENERAL CONDITIONS OF CONTRACT - COMPOSITE WORKS	
Rev. No	0	Page 6 of 104

On receipt of the contract, the associate shall return to TPCODL copy of the contract document duly signed by legally authorized representative of associate, within two days of Effective Date of Contract for contracts having contract execution time less than 30 days and within five days for all other contracts.

### **3.2 Contract Commencement Date**

The date of issue/award of contract shall be the Effective Date of Contract or Contract Commencement date.

### **3.3 Contract Completion Date**

The date of expiry of Guarantee Period (detailed in section 12 of this document) shall be deemed as the Contract Completion Date.

### **3.4 Contract Period/Time**

The period from Contract Commencement Date to Contract Completion Date shall be deemed as the Contract Period/Time.

### **3.5 Contract Execution Completion Date**

The stipulated date for completing the execution of all items in the schedule of quantities (Supply, Service and or both as applicable) shall be deemed as the Contract Execution Completion Date.

### **3.6 Contract Execution Period/Time**

The Period from Contract Commencement Date to Contract Execution Completion Date shall be the Contract Execution Period/Time. Timely Completion of Works/Timely Delivery of Materials is the essence of the contract. The period from effective date of contract to the date stipulated for completion of delivery of all items/completion of all the works/services, as per schedule of quantities of the contract is defined as contract execution completion time. The Delivery of Materials /The Completion of Works, as applicable, should be achieved in all respects as per schedules of quantities and all the terms and conditions of the contract, in the contract execution time.

Any revision/amendment in the originally stipulated contract execution time has to be approved by authorized representative of TPCODL.

### **3.7 Contract Price /Value**

The total all inclusive price/value mentioned in the LOI/PO/RC of the contract document is the Contract Price/Value and is based on the quantity, unit rates and prices quoted and awarded and shall be subject to adjustment based on actual quantities supplied/actual measurement of work done and accepted and certified by the authorized representative of the company unless otherwise specified in schedule of quantities or in contract documents.

### **3.8 Contract Document**

The Contract Document shall mean and include but not limited to the following:

- NIT/Tender Enquiry, QR, Instruction to Bidders, Special Condition of Contract (SCC) of tender, GCC, Technical & Commercial Specifications including relevant annexure and attachments).
- Bids & Proposals Received from Associate including relevant annexure/attachments.

Doc. Title	GENERAL CONDITIONS OF CONTRACT - COMPOSITE WORKS	
Rev. No	0	Page 7 of 104

- Letter of Intent (LOI/RC/PO) with agreed deviations from the tender/bid documents.
- All the Inspection and Test reports, Detailed Engineering Drawings.
- Material Dispatch Clearance Certificate (MDCC).
- Minutes of Meeting (MoM)

### 3.9 Contract Language

All documents, instructions, catalogues, brochures, pamphlets, design data, norms and calculations, drawings, operation, maintenance and safety manuals, reports, labels, on deliveries and any other data shall be in English Language.

The Contract documents and all correspondence between the TPCODL, Third Parties associated with the contract, and the Associate shall be in English language.

However, all signboards required indicating "Danger" and/or security at site and otherwise statutory required shall be in English, Hindi, and local languages.

### 3.10 Reverse Auction

TPCODL reserves the right to conduct the reverse auction (instead of public opening of price bids) for the products / services being asked for in the tender. The terms and conditions for such reverse auction events shall be as per the Acceptance Form attached in Annexure J. The bidders along with the tender document shall mandatorily submit a duly signed copy of the Acceptance Form as mentioned in the Annexure J as a token of acceptance for the same.

### 4.0 SCOPE OF WORK

All the activities that are to be undertaken by the Associate to realize the contractual deliverables in completeness form Scope of Work. Following clauses list, but not limited to, major requirements of the scope of work.

The associate shall satisfy himself and undertake fully the technical/commercial requirements of items to be supplied as listed in the Schedule of Quantities together with the tests to be performed /test reports to be furnished before dispatch, arrangement of stage and final inspections during manufacturing as per terms and conditions of contract, technical parameters & delivery terms and conditions including transit insurance to be met in order to fully meet TPCODL's requirements.

Completeness: Any supplies and services which might have not been specifically mentioned in the Contract but are necessary for the scope mentioned in Special Terms & Conditions and/or completeness of the works at the highest possible level, including any royalties, licence fees & compensation to be paid, whether incurred by the associates or by a third party for the work covered in the scope, regardless of when incurred, shall be supplied/provided by the associate without any extra cost and within the time schedule for efficient , smooth and satisfactory operation and maintenance of the works at the highest possible level under Indian conditions (but according to international standards for facility of this type), unless expressly excluded from the scope of supplies and services in this Contract.

TPCODL have the right, during the performance of the Contract, to change the scope and/or technical character of the Project and/or of the supplies and services stipulated in the

Doc. Title	GENERAL CONDITIONS OF CONTRACT - COMPOSITE WORKS	
Rev. No	0	Page 8 of 104

Contract by submitting a request in writing to the Associate. The Associate shall, within fifteen days of receipt of such request from the TPCODL, provide Purchaser with a reasonably detailed estimate of the cost of the change outlined in the request.

In the event, TPCODL requests a change, the Contract price and time shall be adjusted upwards or downwards, as the case may be and shall be mutually agreed to. The associate shall not be entitled to any extension of time unless such changes adversely affect the time schedule.

The Associate shall not proceed with the changes as requested till adjustment of contract price and time schedule where so applicable in terms of or otherwise directed by the TPCODL.

#### 4.1 Technical Evaluation

TPCODL reserves the right to assign scores to different parameters including but not limited to the following while evaluating the bids. TPCODL reserves the right to change the parameters and score without prior information to the associates:

S. No.	Evaluation Parameter	Max. Score
<b>A</b>	<b>Bidders already Registered with TPCODL</b>	<b>100</b>
	<b>Quality of the Products &amp; Services</b>	
	a. <u>For Supply Part:</u> No Material Rejections in last 2 years Deduction of 3 marks for each PO/ RO (for same product category) with major rejections in last 2 years. (Major rejection shall be considered when material is taken back by the vendor for rectification and the quantity of rejected material is more than 10%).	12
<b>A.1.</b>	b. <u>For Service Part:</u> No violation of statutory compliances in last 1 year. Deduction of 2 marks for each instance of violation in last 1 year.	12
	c. <u>Safety</u> Deduction of 2 marks for each instance of safety violation in last 1 year. Deduction of 4 marks for each reported Non-Fatal Accident in last 1 year. In case of any reported fatal accident: <b>ZERO MARKS</b>	16
<b>A.2.</b>	<b>Timely Execution of Contracts</b> Total Achieved Score = {30 – 3 x (Avg. %age LD deductions in last 2 years)}	30
<b>A.3.</b>	<b>Legal Issues with TPCODL</b> Zero instances of Arbitration procedures / Court Cases / PBG forfeitures in last 2 years: 30 marks else 'Zero' marks	30
<b>B</b>	<b>Bidders new to TPCODL</b>	<b>100</b>
	<b>Visits</b> <u>For Supply Part:</u> Factory Visit and Evaluation. <u>For Service Part:</u> Client Site Visit where the bidder is providing similar services.	30
<b>B.1.</b>	The visits as above shall be arranged by the bidder. However all costs towards conveyance, lodging, boarding etc. shall be borne by TPCODL. The score assigned by TPCODL based on the above visits shall be final and binding on the bidder. <b>Safety:</b>	20

Doc. Title	GENERAL CONDITIONS OF CONTRACT - COMPOSITE WORKS	
Rev. No	0	Page 9 of 104

S. No.	Evaluation Parameter	Max. Score
	Score achieved against the BA safety Management System questionnaire.	
<b>B.2.</b>	<p><b>Client Referrals</b> At least 3 nos. Customer References for similar products/ services in last 3 years. All customer references shall be either of the following:</p> <ul style="list-style-type: none"> <li>▪ Govt. Organizations/ PSUs/ Power Distribution Utilities.</li> <li>▪ Private Organizations with an annual turnover of <math>\geq</math> 500 cr.</li> </ul> <p>PO copies or Completion Certificates are admissible. Each reference: 10 marks</p>	30
<b>B.3.</b>	<p><b>Blacklisting Information</b> Not blacklisted by any reputed organization / utility in last 2 years: 20 marks else 'Zero' marks.</p>	20

- Bidder shall be considered as technically qualified if they are able to achieve a technical score of  $>70$  marks on the above parameters. 'A' or 'B'.
- The bidder must have the PF and ESI registration. In case it is not there (provided the bidder is not exempted from the PF and ESI), bidder shall not be evaluated on the above parameters and will be considered as disqualified.

#### 4.2 Indemnity

Associates shall undertake to fully indemnify TPCODL (also referred to as the Company in the GCC) against all kinds of liabilities or damages, of whatsoever nature, including compensation arising from any accident to the person or property of those in Associate's employment or to any other person or properties including those of TPCODL, arising due to reasons attributable to any, act, omission or negligence of the Associate the Associates, for the entire period of contract including period of guarantee.

Within 7 days of award of work, the Associates shall submit Indemnity Bond in the format as per Annexure-E to Order Issuing Authority.

Contract having value more than Rs 2 Cr per Annum, Associates shall submit Indemnity Bond on Rs 100/- Non Judicial Stamp Paper in the format as per Annexure- E to Order Issuing Authority.

#### 4.3 Display of Notice Boards at Work Sites

The Associate shall put up display notice board at each project site where the works are in progress indicating the information given below:

- Name of the Project.
- Estimated Cost of Project.
- Date of Commencement.
- Expected date of completion.
- Name of Associate and his telephone number.
- Name of Engineer-in-Charge and his telephone number.

#### 4.4 Disposal of Waste at Site

Significant quantities of waste are generated during the execution of project and an integrated approach for effective handling, storage, transportation and disposal of the same shall be adopted. This would ensure the minimization of environmental and social impact in order to combat the climate change.

Doc. Title	GENERAL CONDITIONS OF CONTRACT - COMPOSITE WORKS	
Rev. No	0	Page 10 of 104

The associates shall follow the below criteria for disposal of waste at site during the execution of project.

- Associate shall ensure that the detailed project plan include the waste management, segregation of all designated waste material (Recyclable/ Non-Recyclable), collecting, storing, disposing and transferring the same to pre-arranged facility/destination in timely and safe manner as per environmental legislations during the execution of project. The project plan shall also include the innovative construction practice to eliminate or minimize waste, protect surface/ground water, control dust and other emissions to air and control noise during the execution of project. The copy of same shall be given to EIC before the commencement of project.
- The purchase policy of BA shall encourage the procurement of material with recycled and minimum packaging of goods during delivery. Associate shall provide the appropriate means for site to site transportation of materials to avoid damage and litter generation.
- Associate shall educate and inform to its project team about the requirement and responsibilities for waste minimization and disposal in general and provide training of practices that support this. Waste management should be treated like a safety program.
- In the event that area of contaminated or biological hazard is identified, Associate shall ensure that plant, equipment, personnel and any activity associated with the work is carried out in consultation with EIC of TPCODL.
- Associate shall ensure that the residents living near the site are kept informed about proposed working schedule and shall informed timings and duration of any abnormal noise full activity that is likely to happen.
- Associate shall ensure the regular maintenance and monitoring of vehicles and equipment for efficient fuel use so that emissions and noise are within acceptable limits to avoid air pollution.

#### **4.5 Deployment of Work Force**

Associate shall deploy adequate labour, as considered necessary by TPCODL for execution of the contract including Sundays and Holidays whenever required to do so with no extra cost to TPCODL. However, prior permission shall be taken from the site Engineer to carry out the work beyond normal working hours or on Sundays and Holidays. Female employees shall not be deployed beyond normal working hours/days and no child labour shall ever be deployed. Associate shall depute full time qualified and experienced engineers to supervise the work at site. All such staff shall be maintained from commencement to completion of all works to the entire satisfaction of the Engineer-in-Charge. Associate's employees deployed for the works under this contract will not be considered in Company's employment at any time. Associate shall continue to be responsible for all such employees, their safety, all types of statutory compliances related thereto and in any other manner whatsoever. The company will stand indemnified by the Associate in respect of all the above. At the same time Company upon noticing any breach or default on any statutory compliances, may at their sole discretion, decide to act in a manner as deemed fit at the risks and costs of the Associate.



Doc. Title	<b>GENERAL CONDITIONS OF CONTRACT - COMPOSITE WORKS</b>	
Rev. No	0	Page 11 of 104

TPCODL shall have the right to instruct the Associate to change the Sub- Associates or skilled /unskilled workers in case the conduct, the workmanship or speed of the work is not satisfactory.

Associates shall submit duly signed undertaking regarding engagement of competent staff / employee commensurate to the nature of job to Engineer-in-charge in the format attached as Annexure – H.

#### **4.6 Damages to Properties**

The Associates shall take necessary steps to ensure that the equipment and installations of the Company, Third parties, including other utility services like water supply pipelines; open drains telephone cables etc. are not damaged during execution of the works. The Associates shall be responsible for all such damages and shall have to repair/ replace and/or compensate for the entire claims in respect of such damages at its own cost.

#### **4.7 Issuance of Material**

The material issued to the Associate shall be in the custody of the Associates who shall be fully responsible for the same. After completion of the works, the Associates will reconcile the material. Any cost of material which is short or damaged/lost will be deducted from Associate bill/ deposits.

#### **4.8 Company's Right To Use Works**

If Taking Over Certificate is delayed for any reason, for which TPCODL's decision shall be final and binding upon the Associate, the Company shall be entitled to use the works or portion thereof without affecting Associate's responsibility and liability to complete the balance works as per company's directives from time to time, though Associate shall be afforded reasonable opportunity by the company to enable Associates to complete all balance works required for issuance of 'Taking Over Certificate' by the company.

#### **4.9 Rights of TPCODL to vary the scope work**

TPCODL shall have the right, during the performance of the Contract, to change the scope and/or technical character of the Project and/or of the supplies and services stipulated in the Contract by communicating the intent to do so in writing to the Associate. On receipt of such communication the Associate shall, within the time frame specified in the contract shall provide TPCODL with a reasonably detailed estimate of the cost of the change in scope outlined in the TPCODL communication. The change in the Contract price and time shall be revised upwards or downwards, as the case may be, and shall be mutually agreed to. The Associate shall not be entitled to any extension of time unless such changes adversely affect the time schedule.

The Associate shall not proceed with the changes in the scope of work till such time revision of Contract price and time schedule are approved and communicated to the associate by TPCODL.

Any change in the Scope of Work and/or Terms & Conditions of the order shall be intimated by TPCODL through an amendment to the contract. The amendment shall be treated valid only if signed by the authorized signatory of the original contract.

### **5.0 PRICES/ RATES/ TAXES**

#### **5.1 For Supply part of Contract**

Doc. Title	<b>GENERAL CONDITIONS OF CONTRACT - COMPOSITE WORKS</b>	
Rev. No	0	Page 12 of 104

Unless specified elsewhere in the contract document, the prices/rates are inclusive of cost of finished product for which MDCC will be issued by TPCODL, packaging and forwarding charges, freight and transit insurance charges covering loading at Associate's works, transportation to TPCODL store/site & unloading & delivery at TPCODL stores/TPCODL site, cost of documentation including all the relevant test certificates and other supportive documents to be furnished.

The Prices/Rates are inclusive of all taxes, levies, cesses and duties, particularly Goods and Services Tax as applicable. All government levy / taxes shall be paid only when the invoice is submitted according to the relevant act.

The prices/rates shall remain firm till actual completion of entire supply of goods/material/equipment as per contract is achieved and shall remain valid till the completion of the contract.

The prices shall remain unchanged irrespective of TPCODL making changes in quantum in all or any of the schedules of items of contract.

## **5.2 For Service part of Contract**

The Prices and Rates are inclusive of cost of materials supplied as per contract terms and for which MDCC is issued by TPCODL and to the extent required for completion of works, cost of service executed as per schedule of quantities, cost of testing as per contract terms, cost of documentations including all relevant test certificates and other supportive documents to be furnished as per contract terms. The rates shall remain firm till actual completion of contract.

The Prices/Rates are inclusive of all taxes, levies, cesses and duties, particularly Goods and Services Tax as applicable. All government levy / taxes shall be paid only when the invoice is submitted according to the relevant act.

The prices shall remain unchanged irrespective of TPCODL making changes in quantum in all or any of the schedules of items of contract.

## **5.3 Changes in Statutory Tax Structure**

If rate of any or all of the statutory taxes and duties applicable to the contract changes, such changes shall be incorporated by default if the changes occur within the contract execution time and shall be applicable if the contract is executed by the Associate within the Contract Execution Time.

For execution of contracts beyond contract execution time, where the delay is not attributable to TPCODL no upward revision in tax /duties shall be considered irrespective of changes in the statutory tax structure either within the contract execution time or beyond. However, in such cases, benefits due to any downward revisions in statutory tax rates shall be passed on to TPCODL.

## **6.0 TERMS OF PAYMENT**

- A. 5% of the Release Order/ Purchase Order price shall be paid as initial interest free advance on fulfillment of the following by the Associate:
- a) Acceptance of PO/ LOI.
  - b) Submission of advance payment BG of 15% of the Release Order/ Purchase Order price which shall remain valid till the advance is fully adjusted.

Doc. Title	GENERAL CONDITIONS OF CONTRACT - COMPOSITE WORKS	
Rev. No	0	Page 13 of 104

- c) Submission of Contract Performance Bank Guarantee of 5/10% of the RC/ PO price valid till 30 days after taking over of the works.
- B. 10% of the Release Order/ Purchase Order price shall be paid as interest free advance against approval of drawings under Category-1 of major drawings, Quality Plans, Pert Chart, Field Quality Plan, posting of Project Manager and commencement of the first mile stone of the work mutually agreed including C-3 Form, and submission of a true copy of 'Erection All Risk Insurance Policy' taken for the awarded jobs. The drawing list shall be mutually agreed at the time of award of work.
- C. 50% on account payment of the total of item wise cost of material Release Order/ Purchase Order shall be paid against receipt of material at site in good condition and certification by TPCODL along with bills complete in all respects viz. MDCCs etc.
- D. 20% on account payment of the actual executed value shall be paid against mechanical completion of erection on prorata basis against monthly bills and 70% on account of the actual executed value shall be paid against the service line item including composite line item. In case this milestone is not completed beyond 120 days for reasons attributable to TPCODL, the payment corresponding to supply part shall be released subject to submission of BG of equivalent amount by the BA valid for a period of further 12 months. If required, it shall be extended by the BA on request of TPCODL.
- E. 15% payment of the actual executed Release Order/ Purchase Order shall be paid after completion of acceptance test and Taking Over of the complete systems specified in the enquiry, including clearance of Electrical Inspection, compliance of final punch point and after reconciliation & adjustment of payments, if any, towards Quantities of materials issued from purchaser's stock and consumed by the contractor for expeditious completion of the job. In case this milestone is not completed beyond 120 days beyond schedule for reasons attributable to TPCODL, the payment corresponding to supply part shall be released subject to submission of BG of equivalent amount by the BA valid for a period of further 12 months. If required, it shall be extended by the BA on request of TPCODL.

The Contractor shall submit all Operation & Maintenance manuals and "As Built Drawings" etc. and shall also submit Equipment Warranty Bank Guarantee (EWBG) equivalent to 5/10% of actual executed contract price before the release of this last payment and return of CPBG. The validity of EWBG shall be for a period of 15 months from the date of taking over of the works or specified guarantee period in drawing/tender/technical specification documents etc. whichever is later. The associate shall also submit 'No Demand Certificate' at the time of receipt of full and final payment.

### 6.1 Pre-Requisites for Payment

- Associate should have completed execution of that part of contract, for which payment is sought, to the satisfaction of TPCODL's Engineer-in-Charge responsible for the contract and obtained certification for execution of the work.
- Associate has undertaken joint measurement of the work executed along with TPCODL's Engineer-in-charge

Doc. Title	GENERAL CONDITIONS OF CONTRACT - COMPOSITE WORKS	
Rev. No	0	Page 14 of 104

- Associate's bills/invoices submitted have been certified by Engineer-In-Charge.

## 6.2 Bills & Invoices

Unless specified otherwise in the special conditions of contract, Associate shall raise not more than one invoice/contract per month for the services rendered in the prescribed Tax Format and the invoice shall be submitted within 15 days of the following month at Bill Inward Receipt Desk (BIRD) located at Civil Lines III Office, TPCODL.

All Bills shall be supported by joint measurement of work done, quality test report and a copy of wage sheet, if applicable (showing proof of having disbursed wages as per applicable law) and a copy of statement substantiating that statutory payments having been affected.

Bills/ invoices shall mention Associate's 'Sales, Service, WCT Tax Registration Number, PAN number as applicable.

Final bill submission after completion of project or execution of job must be within 30 days from the actual date of completion/execution of work awarded.

## 6.3 Payment & Statutory Deductions

Payment shall be released within 30 days from the submission of the bills. The associate shall submit "No Demand Certificate" in the format as per Annexure-D at the time of receipt of full and final payment. In case any non-compliance to contract conditions comes to TPCODL's notice, TPCODL will be entitled to deduct 30% of estimated wages plus 20% of wages as TPCODL's overheads. Associates would be obliged to provide the copy of monthly wage sheet in any case, failing which no payment shall be made. TPCODL at their sole discretion may deposit the PF etc. with statutory authorities. TPCODL will deduct the amounts of TDS as per statutory requirement under the income tax act and the DVAT Act and certificates (wherever applicable) will be issued to associate accordingly.

In case of non-submission of PAN No TDS @ 20% shall be deducted from all payable amounts for which no TDS certificate shall be issued. TDS once deducted as above shall not be revised in any condition.

### 6.3.1 Statutory Deductions

TPCODL will deduct the amounts of TDS, TCS as per statutory requirement under the income tax act, the Goods and Services tax act, BOCW Act, or any other applicable tax act and certificates (wherever applicable) will be issued to associate accordingly. For consumption of TPCODL's Water and Electricity by Associate for execution of Contract, Associate shall pay 0.5% & 1.0% respectively of contract value and it shall be deducted from the running bills. The Engineer-in-Charge as stated in the Order shall be responsible for certification of the work executed and the bills. Bills (including original) shall be submitted in triplicate at Bill Inward Receipt Desk (BIRD) located at Civil lines-III, Near Vidhan Sabha, TPCODL.

## 6.4 Guidelines for Raising Running/Final Bills

Contract Value Up to 5 Lakhs	One Final Bill
Contract Value More than 5 lakhs	Monthly Running Bill & One Final Bill

All Bills shall be processed only when all bank Guarantees are in place and before payments of Final Bill Associate have to furnish NDC.

Doc. Title	<b>GENERAL CONDITIONS OF CONTRACT - COMPOSITE WORKS</b>	
Rev. No	0	Page 15 of 104

## **6.5 Quantity Variation**

Payment will be made on the basis of actual quantity of supplies/actual measurement of works accepted by TPCODL and not on the basis of contract quantity.

## **6.6 Full and Final Payment**

Full & Final Payment in all contracts shall be made subject to the associate submitting "No Demand Certificate" in the format as per Annexure-D.

## **7.0 MODE OF PAYMENT**

Payment shall be made through RTGS mode for which Business Associated shall submit the details of Bank Account and other details as per annexure K. Further, for any payments made, TPCODL is not responsible for any consequences/disputes Associate have among the owners channel partners, sub-Associates and all such dispute/concerns shall be settled solely by the Associate.

The quantities of items indicated are estimated and preliminary. However, payments shall be made on the basis of actual quantity of work carried out and measured jointly by the Company and the Associate. Associates shall be responsible to organize joint measurements of works with TPCODL Engineer-in-Charge before raising any bill of work done. In the event Associate fails to do so, TPCODL at their sole discretion, may take measurements of work done and proceed as deemed fit and in such an event Associate's right to lodge any subsequent claim shall stand forfeited.

## **8.0 SECURITY CUM PERFORMANCE DEPOSIT**

Associates shall submit within 15 days from the effective date of issue of PO/RC, Security cum Performance Guarantee (SPBG) in the format as per Annexure B of this document from banks acceptable to TPCODL for:

- (a) 5% of the PO value if purchase order value is more than Rs 5 Crores.
  - (b) 10% of the PO value if purchase order value is less than Rs 5 Crores.
- This shall remain valid till the end of the Guarantee Period of contract, plus one month.
- (c) 5% of the RC value in case of Rate Contract. This shall remain valid till the Guarantee period plus one month.
    - For PO/RC values less than Rs. 5 lacs, Associate may request for deduction of amount equivalent to SPBG value from their first invoice. Such amount shall be withheld by TPCODL while processing the invoice and shall be released after completion of Guarantee Period plus one month.
    - For PO/RC values less than Rs. 3 lacs, the clause (8.0) for Security cum Performance Bank Guarantee (SPBG) shall not be applicable..
    - In case of RC (Rate Contract) after the expiry of RC validity, Associate shall have to submit SPBG. However, the Associate has the option to re-submit the SPBG as per actual RO (Release Order) value issued against the RC, valid for Guarantee Period plus one month. The Guarantee Period shall be considered as per the last RO issued against the said RC. The original SPBG as submitted against the RC shall be released on submission of the new SPBG to TPCODL. Alternatively, Associate may extend the

Doc. Title	GENERAL CONDITIONS OF CONTRACT - COMPOSITE WORKS	
Rev. No	0	Page 16 of 104

validity of original SPBG only till the requisite period, i.e. Guarantee Period plus one month.

## 9.0 STATUTORY COMPLIANCE

### 9.1 Compliance to Various Acts

Associate should ensure adherence to all applicable laws, rules and regulation applicable under this contract from time to time. In case of violation any risk, costs etc shall be in associates account and keep TPCODL indemnified always till completion of contracts.

### 9.2 SA 8000

Further being TPCODL is SA 8000 complied and expects its Associates to follow guidelines of SA8000: 2014 on the following aspects

1. Child Labour
2. Forced or Compulsory Labour
3. Health & Safety
4. Freedom of Association & Right to Collective Bargaining
5. Discrimination
6. Disciplinary Practices
7. Working Hours
8. Remuneration
9. Management System

### 9.3 Affirmative Action

TPCODL appreciate and welcome the engagement/employment of persons from SC/ST community or any other deprived section of society by their business associates.

#### Relaxation in Contract Clauses under Affirmative Action for SC/ ST Business Associates\*\*

TPCODL believes that inclusive growth is the key to sustainable development, and to promote the same Policy on Affirmative Action for Scheduled Caste & Scheduled Tribe Communities has been adopted across the company.

Under the same pre-text, and to promote entrepreneurship among SC/ST community TPCODL has taken initiative by proposing relaxations in contract clauses as per below:

S. No.	Initiative	for SC/ ST BA's	Guideline Document
1	Tender Fees	100% waiver for SC/ST community	All Open Tenders
2	Earnest Money Deposit	50 % relaxation of estimated EMD value	All limited and Open Tenders
3	Performance Bank Guarantee	25% relaxation in PBG for order value above 50 lacs else 50% relaxation	All limited and Open tenders
4	Turnover	25% relaxation in company turnover under qualifying requirement criteria	All Open Tenders

Doc. Title	GENERAL CONDITIONS OF CONTRACT - COMPOSITE WORKS	
Rev. No	0	Page 17 of 104

**\*\*Classification of BA s under SC/ST shall be governed under following guidelines:**

- Proprietorship/ Single Ownership Firm: Proprietor of the firm should be from SC/ST community. Governing document shall be duly audited balance Sheet for the last FY bearing the name of proprietor.
- Partnership Firm: Only such firms shall qualify which have SC/ST partners holding equal to or more than 50% of the total ownership pattern of the firm. Governing document shall be Partnership Deed and audited balance sheet/ ITR for last FY.
- Private limited company: Only such firms shall qualify which have SC/ST directors holding equal to or more than 50% of the total ownership pattern of the firm. Governing document shall be Memorandum of Understanding (MoU) and/or Article of Association (AoA).

*## Certification from SC/ST commission shall be required for deciding upon SC/ST status of a person.*

**9.4 Compliance to Labour Laws**

Bidder needs to ensure compliance to applicable labour laws including timely disbursement of wages. In case wages are not disbursed as per the stipulated timelines, then TPCODL shall pay the wages to BA employees on behalf of BA. Apart from deducting the amount of wages paid, TPCODL shall deduct an additional service charge equivalent to 25% of the wages paid from the payment due to BA.

**9.5 Compliance to Construction and Demolition Waste Management Rules & Environment (Protection) Amendment Rules**

BA is liable to follow the Construction and Demolition Waste Management Rules- 2016, Environment (Protection) Amendment Rules- 2018 and Guidelines on dust mitigation measures in handling construction material and C&D wastes issued by CPCB.

Following are some main points of above Rules/Guidelines for Construction work, cable laying jobs etc.

1. Barricading to be provided at site to cover complete area.
2. Construction material and waste should be inside the closed area made by using barricading.
3. Water sprinkling/fine spray from nozzles to be done to suppress the dust.
4. The board of Dust mitigation measures shall be displayed at site for public viewing with required details.
5. Loose sand or soil and construction material that causes dust shall be covered.
6. Transport material that are easily wind borne need to be covered by a sheet made of either jute, tarpaulin, plastic or any other effective material.
7. All areas for storing C&D waste/construction material to be demarcated and preferably barricaded particularly those materials that have potential to be dust borne.
8. Grinding and cutting of building materials in open area shall be prohibited.
9. Construction material and waste should be stored only within earmarked area and road side storage of construction material and waste shall be prohibited.
10. No uncovered vehicles carrying construction material and waste shall be permitted.
11. Construction and demolition waste processing and disposal site shall be identified and required dust mitigation measures to be notified at the site.

Doc. Title	GENERAL CONDITIONS OF CONTRACT - COMPOSITE WORKS	
Rev. No	0	Page 18 of 104

## **10.0 QUALITY**

### **10.1 Knowledge of Requirements**

The Associate shall be deemed to have carefully examined and to have knowledge of the equipment, the general and other conditions, specifications, schedules, drawings, etc. forming part of the Contract and also to have satisfied himself as to the nature and character of the work to be executed and the type of the equipment and duties required including wherever necessary of the site conditions and relevant matters and details. Any information thus procured or otherwise obtained from TPCODL/Consultants shall not in any way relieve the Associate from his responsibility and executing the works in accordance with the terms of contract.

### **10.2 Material/Equipment/Works Quality**

The items / works under the scope of the Associate shall be of the best quality and workmanship according to the latest engineering practice and shall be manufactured from materials of best quality considering strength and durability for their best performance and, in any case, in accordance with the specifications set forth in this Contract. All material shall be new. Substitution of specified material or variation from the process of fabrication/construction/manufacture may be permitted but only with the prior written approval of the TPCODL.

### **10.3 Adherence to Rules & Regulations**

The Associate shall procure and/or fabricate/erect all materials and equipment in accordance with all requirements of Central and State enactment, rules and regulations governing such work in India and at site. This shall not be construed as relieving the Associate from complying with any requirement of TPCODL as enumerated in the Contract which may be more rigid than and not contrary to the above mentioned rules, nor providing such construction as may be required by the above mentioned rules and regulations. In case of variance of the Technical Specification from the laws, ordinance, rules and regulations governing the work, the Associate shall immediately notify the same to the TPCODL. It is the sole responsibility of the Associate, however, to determine that such variance exists. Wherever required by rules and regulations, the Associate shall also obtain the statutory authorities' approval for the plant, machinery and equipment to be supplied by the Associate.

### **10.4 Specifications and Standards**

The Associate shall follow all codes and standards referred in the Contract Document. Codes and standards of other may be followed by the Associate with the prior written approval of TPCODL, provided materials, supplies and equipment according to the standard are equal to or better than the corresponding standards specified in the Contract.

Brand names mentioned in the Contract documents are for the purpose of establishing the type and quality of products to be used. The Associate shall not change the brand name and qualities of the bought out items without the prior written approval of the TPCODL. All such products and equipment shall be used or installed in strict accordance with original manufacturer's recommendations, unless otherwise directed by the TPCODL. In any



Doc. Title	<b>GENERAL CONDITIONS OF CONTRACT - COMPOSITE WORKS</b>	
Rev. No	0	Page 19 of 104

circumstances the codes, specimen and standards prescribed by any government agency should not be violated.

## **11.0 SAFETY**

All Associates shall strictly abide by the guidelines provided in TPCODL's Contractor Safety Management System (CSMS) as applicable at all stages during the contract period. Associate shall execute the contracts ensuring the following in and as order of priority:

- Safety of Human Beings.
- Safety of equipment/Assets.
- Timely Completion of Contract.

Safety related requirements as mentioned in our Contractor Safety Management System is attached as annexure L and is an integral part of this GCC.

## **12.0 INSPECTION/PARTICIPATION**

### **12.1 Right to Carry Out Inspection**

TPCODL reserves the right to send its representatives for inspection or participation at various stages of contract execution listed below, applicable as per contract construction.

- During basic design and detail engineering of material/ Equipment carried out by Associate /Outsourced Agencies.
- During manufacturing stages of the product at Associate's/Associate's Outsourced Agency's Plant/Facility.
- During Pre-dispatch Inspection and Testing of finished/manufactured product at Associate's/Associate's outsourced Agency's Plant/Facility.
- During Installation & Commissioning Activities/Stages.
- Prior to Clearing of the completed installation for commissioning.
- Any other stage as find appropriate by TPCODL during contract execution time.

All inspections and participations shall be carried out within maximum of two weeks of TPCODL giving written intimation to the Associate or receiving appropriate advance written inspection call from the Associate, unless otherwise specified elsewhere in the contract document.

### **12.2 Facilitating Inspection**

The Associate shall provide all opportunities and information to TPCODL's engineers to get acquainted with the technical know-how and the methods and practices adopted by the Associate in basic and detail engineering. The Associate shall provide documents, drawings, calculations etc. as may be required by TPCODL's Engineers.

The Associate shall provide free of charge office accommodation, office facilities, secretarial services, communication facilities, general and drawing office stationary, etc. as may be reasonably required by the TPCODL's engineers. Similarly, facilities shall also be provided by Associate's outsource agencies/partners/authorized dealers (collectively termed as sub-associates) if such basic and detail engineering activities are carried out in the design offices of sub-Associates.

Doc. Title	<b>GENERAL CONDITIONS OF CONTRACT - COMPOSITE WORKS</b>	
Rev. No	0	Page 20 of 104

The Associate shall be responsible for the safety of employees of TPCODL/Third Party Agency when they are at the Associate's /Associate's outsource agency's plant or facility for carrying out/witnessing inspection/testing. All statutory safety precautions as applicable shall be followed by the Associate during Inspection Testing. If TPCODL inspectors are not satisfied with the safety arrangements at the plant, TPCODL have the right to call off inspection till such time corrective action is taken by the Associate.

Before raising the call for pre-dispatch final inspection and testing, the Associate shall conduct all the tests—type tests, routine tests etc-as specified in the contract document and submit copies of the test certificates to TPCODL along with the inspection call, for scrutiny of TPCODL.

The Associate and TPCODL shall jointly document all the observations, comments and action points after completion of inspection and it shall be binding on the Associate to provide compliance on all the points requiring compliance and furnish the compliance report to the designated authority of TPCODL for receiving clearance for dispatch of materials.

### **12.3 Third Party Nomination**

TPCODL also may nominate a third party for the purpose of carrying out the inspection and such an agency shall be entitled to all the rights and privileges of TPCODL as far as conducting the inspection.

### **12.4 Waiver of Inspections**

TPCODL on its own discretion shall chose to waive off any inspection and ask the Associate to submit all the test reports as applicable as per contract specifications, related to inspection and testing of the goods ordered for scrutiny and clearance for dispatch.

### **12.5 Incorrect Inspection Call**

In case it is observed that the material offered for inspection is not ready at the time of TPCODL inspection visit rendering it as futile, all costs towards such inspection shall be recovered from the BA. Taxes as applicable on such recoveries shall be borne by the BA.

## **13.0 MDCC & DELIVERY OF MATERIALS**

### **13.1 Material Dispatch Clearance Certificate**

Associate shall deliver material/goods/equipment against Supply Contracts or Supply Part of Composite/Service Contracts only after receiving Material Dispatch Clearance Certificate (hereafter termed as MDCC) issued by designated authority of TPCODL. Material delivered at TPCODL stores or at project site without a valid MDCC issued by the designated official of TPCODL shall be rejected. MDCC shall be issued to associate furnishing compliance report on the action points documented during pre-dispatch inspection and testing at Associate's/ Sub-Associate's plant/ facility. In case Pre-dispatch inspection is waived at the discretion of TPCODL, then, MDCC shall be issued on receiving all the test reports-routine& type-from the Associate and finding them in order.

The associate shall include and provide for securely protecting and packing the materials so as to avoid loss or damage during handling and transport by air, sea, rail and road or any other means.

All such packing shall allow to the extent possible for easy removal and checking at Site. The associate shall take special precautions to prevent rusting of steel and iron parts during

Doc. Title	<b>GENERAL CONDITIONS OF CONTRACT - COMPOSITE WORKS</b>	
Rev. No	0	Page 21 of 104

transit by sea. Gas seals or other materials shall be utilised by the associate for protection against moisture during transit of all Plant and Equipment.

Each Equipment or parts of Equipment shall be tagged with reference to the assembly drawings and corresponding part numbers. Each bale or package shall contain a packing note quoting specifically the name of the associate, item description, quantity, item / package identification.

All packing cases, containers, packing and other similar materials shall be new and supplied free by the associate and it shall not be required to be returned to the associate.

Notwithstanding anything stated in this clause, the associate shall be entirely responsible for loss, damage or depreciation or deterioration to the materials and supplies due to faulty and/or insecure packing or otherwise during transportation to the Site until otherwise provided herein.

In case of the consignments dispatched by road, the associate shall ensure that it or its sub-contractors:

- i) Identify and obtain the correct type of trucks/trailers, keeping in view the nature of consignments to be dispatched.
- ii) Take such actions as may be necessary to avoid all possible chances of damages during transit and to ensure that all packages are firmly secured.

Timelines for inspection and MDCC is as below:

S. No.	Inspection	MDCC issuance time including inspection time (max.)
1	Outside Bhubaneswar	12 days
2	Within Bhubaneswar	5 days
3	Waiver*	3 working days

\* Associate is expected to raise the inspection call assuming that Inspection shall be carried out by TPCODL. The decision for waiver of inspection shall be on sole discretion of TPCODL.

### 13.2 Right to Rejection on Receipt

Goods/Material/Equipment delivered in condition physically damaged & incomplete as a product ordered, or not packed and transported as per the terms and conditions of the contract is liable to be rejected. Such item shall be lifted back by Associates within 15 days from receipt of rejection note from TPCODL and have to supply back the material within next 30 days or within the timeframe mutually decided by Associate and TPCODL.

If delivery of the material is beyond the agreed time, Liquidated damage clause, mentioned in this GCC separately shall be applicable; but the period for levy of LD shall be considered as per the original delivery schedule and not from the agreed timelines for material rectification.

### 13.3 Consignee

Unless otherwise specified in the Contract Document, Materials/Goods/Equipment shall be consigned to "Stores-In-Charge", TPCODL Bhubaneswar.

### 13.4 Submission of mandatory documents on Delivery

Doc. Title	GENERAL CONDITIONS OF CONTRACT - COMPOSITE WORKS	
Rev. No	0	Page 22 of 104

Following documents shall be mandatorily submitted by BA along with supply of material to TPCODL stores/site:

S. No.	Documents	Requisite
1	Invoice copy in original	With all consignments
2	LR copy	Wherever required
3	Packing list	With all consignments
4	MDCC	With all consignments
5	Purchase order / Release order	Signed copy
6	Test certificates	With all consignments
7	Inspection/JVR report	In case pre-dispatch inspection is conducted
8	Device data in CD as per template for metering items	Wherever applicable

### 13.5 Dispatch and Delivery Instructions

S. No.	Instructions
1	Purchase order/ Release order no. shall be mentioned on invoice and on material
2	TPCODL material code and material description shall be mentioned in invoice and on material.
3	"Property of TPCODL" shall be embossed on material.
4	The material shall be properly sealed and packed in standard packing as per purchase order terms & conditions.
5	The weight and quantity of material shall be mentioned wherever applicable
6	The material supplied shall be co-related with the packing list.
7	The name plate detail on equipment shall include Material code, Material description, specification detail of material [as applicable], Serial No. Year of manufacturing, PO/RO no. and date, "PROPERTY OF TPCODL, Bhubaneswar", Guarantee period and Associate's name.
8	In case of manual unloading, supplier / transporter shall deploy sufficient Labour for unloading the material at TPCODL central store. For heavy item(s), crane will be provided by TPCODL [unloading cost will be recovered from the associate].
9	The driver should have valid License and one helper in truck. All the documents of truck like registration papers, PUC etc should be available in Truck.
10	BA representative should accompany the material and get it unloaded / stacked in his presence wherever possible.

### 14.0 GUARANTEE

#### 14.1 Guarantee of Performance

Associates shall stand guarantee that the equipment and material supplied/service or work rendered under the contract is free from design, manufacturing, material, construction, erection & installation and workmanship & quality defects and is capable of its due, rated and intended quality performance, as an integrated product delivered under the contract. for a specific period termed as Guarantee Period(as elaborated elsewhere in this clause) The

Doc. Title	GENERAL CONDITIONS OF CONTRACT - COMPOSITE WORKS	
Rev. No	0	Page 23 of 104

Associate should also guarantee that the equipment/material is new and unused except for the usage required for the tests and checks required as part of quality assurance.

#### **14.2 Guarantee Period**

The Guarantee Period will be equipment/service/work specific and shall be as specified in the Standard Specifications of TPCODL for the equipment/material/service/work and where standard specifications are not part of contract documents or guarantee period is not specified in the standard specifications,, the guarantee period shall be as per the Special Terms and Conditions of the Contract. In case of no mention of the guarantee period in standard specifications or SCC Guarantee Period will be 15 Months from the Date of Commissioning or 24 months from the date of delivery of final lot of supplies made, whichever is earlier.

#### **14.3 Failure in Guarantee Period (GP)**

If the equipment and material supplied/service or work rendered under the contract fails to perform its due, rated & intended quality performance, during the Guarantee period, the associate is liable to undertake repair/rectify/replace the equipment and material supplied/service or work rendered under the contract within time frame specified in the SCC or elsewhere in the contract documents at associate's cost to make the equipment and material supplied/service or work rendered under the contract of performing its due, rated and intended quality performance. If Associate fails to repair/rectify/replace the equipment or material supplied/service or work rendered under the contract, failed in Guarantee Period, TPCODL will be at liberty to get the same done at Associate's risks and costs and recover all such expenses plus the TPCODL's own charges (@ 20% of expenses incurred), from the Associate or from the "Security cum Performance Deposit" as the case may be.

If during the Warranty/ Guarantee period some parts of the supplies are replaced owing to the defects/ damages under the Warranty, the Warranty period for such replaced parts shall be until the expiry of twelve months from the date of such replacement or renewal or until the end of original Guarantee period, whichever is later.

Any repairs during the Guarantee Period shall be carried out by the Associate within 30 days of reporting the issue to Associate by TPCODL. However, if replacement of the Equipment is required, Associate shall notify the same to TPCODL within 7 days of reporting the issue by TPCODL. Thereafter, the total time for supply of new equipment/ material shall be equal to the original delivery period of that equipment/ material as specified in the Contract. In case the Associate is not able to rectify/ replace the faulty equipment/ material within the stipulated timelines as mentioned above, penalty shall be levied as per the Liquidated Damages clause mentioned in this document. The penalty amount shall be recovered from the payment due to the vendor or by encashment of the SPBG as the case may be.

#### **14.4 Cost of repairs on failure in GP**

The cost of repairs/rectification /replacement, apart from the actual cost of repairs/rectification/replacement is also inclusive of all associate costs of required transportation, site inspection /mobilization/dismantling and re-installation costs as applicable, to be borne by the Associate. The Associate has to ensure that the interruption in the usage of intended purpose of the equipment is minimized to the maximum extent In lieu of the time taken for repairs/rectification/replacement.

Doc. Title	GENERAL CONDITIONS OF CONTRACT - COMPOSITE WORKS	
Rev. No	0	Page 24 of 104

#### **14.5 Guarantee period for Goods Outsourced**

If the Associate outsources partly equipment/materials/services from third party as mutually agreed upon at the pre award stage of contract, TPCODL shall have the benefit of any additional guarantee period if provided by the third party for the part supplied/executed by them.

#### **14.6 Latent Defect**

Hidden defects in manufacturing or design of the product supplied and which could not be identified by the tests conducted but later manifested during operation of the equipment are termed as latent defects. Associates shall further be responsible for 'free replacement' for another period of THREE years from the end of the guarantee period for any 'Latent Defects' if noticed and reported by the Company.

#### **14.7 Support beyond the Guarantee Period**

The Associate shall ensure availability of spares and necessary support for a period of at least 10 years post completion of guarantee period of equipment supplied against the contract.

#### **15.0 LIQUIDATED DAMAGES**

Liquidated damages @1% of the total executed contract value per week or part thereof, for the period of delay in integrated completion, subject to maximum 10% of the value of the contract shall become leviable without prejudice to other rights of the TPCODL. This amount shall be recoverable from any amount due or becoming due to the Business Associates under this or any other contract. In specific cases, TPCODL reserves the right to apply LD only on the unexecuted portion of the supply and works for standalone use, provided full quantity is executed within a maximum 30% additional time. Deduction of LD shall be on landed cost i.e contract value inclusive of taxes and in pursuant statutory compliance GST would be applicable at the stipulated rate and the same shall be borne by Business Associate. In case of LD deduction, a GST invoice shall be issued by TPCODL as a proof of deduction/ recovery.

#### **15.1 LD Waiver Request**

Any request of LD waiver shall be submitted within thirty (30) days of deducting LD. Request submitted beyond the timeline shall not be entertained.

#### **15.2 Material Recovery**

In case of any recoveries for materials or services (for material free issued by TPCODL and not reconciled by BA or for services claimed and paid in excess at the time of running bills), the total cost which shall be recovered from the BA, shall be the gross amount of material or services (i.e. including taxes) plus applicable taxes as prevailing at the time of such recoveries.

#### **16.0 ASSIGNMENT OR SUBCONTRACTING**

Associates shall not assign/subcontract/outsource the schedule of activities of contract TPCODL enters with the associate, in part or full, without TPCODL's prior written approval.

Doc. Title	<b>GENERAL CONDITIONS OF CONTRACT - COMPOSITE WORKS</b>	
Rev. No	0	Page 25 of 104

However outsourcing of materials/equipment/services by Associate to make the integrated product for which TPCODL's has placed the contract with the associate from suppliers, makes and agencies which have been mutually agreed upon during contract pre-award stage is permitted subject to following conditions.

In such cases where outsourcing is done by the Associate

- Shall ensure that outsourced suppliers comply with the technical and financial qualification requirements specified by TPCODL in the contract document
- Shall furnish all particulars about the proposed outsourcing agencies and the details of the goods/services/work outsourced to the Associate while seeking approval of TPCODL for inclusion for outsourcing. The Associate shall give approval or shall refuse approval in writing within thirty (30) days of receipt of such request. However the Associate shall not be entitled for any additional contract execution time whatsoever in lieu of the process for approval for outsourcing agencies, and shall be held responsible for any delay in the project execution time.
- Shall remain jointly and severally liable for any action, deficiency, and/or negligence on the part of his outsourcing agencies. The approval extended by the Associate to outsourcing agencies recommended by the Associate shall not discharge the later from his Contract obligations.

Shall submit to the Associate unpriced copies of purchase orders with technical specifications included in the orders, placed on outsourcing agencies as soon as the respective orders have been placed by the Associate.

#### **17.0 UNLAWFUL ACTIVITIES**

The Associate shall have to ensure that none of its employees are engaged in any unlawful activities (whether covered under the scope of the present GCC or not) subversive of the TPCODL's interest failing which appropriate action (legal or otherwise) may be taken against the Associate by the TPCODL, in accordance with the terms of the present GCC.

#### **18.0 CONFIDENTIALITY**

Associate and its employees or representatives thereof shall strictly maintain the confidentiality of various information they come across while executing the contract as detailed below.

##### **18.1 Documents**

All maps, plans, drawings, specifications, schemes and other documents or information related to the Contract/Project and the subject matter contained therein and all other information given to the Associate by the TPCODL in connection with the performance of the contract shall be held confidential by the Associate and shall remain the property of the TPCODL and shall not be used or disclosed to third parties by the Associate for any purpose other than for which they have been supplied or prepared. The Associate may disclose to third parties, upon execution of confidentiality agreements, such part of the drawings, specifications or information if such disclosure is necessary for the performance of the Work provided such third parties agree in writing to keep such information confidential to the same extent and degree as provided herein, for the benefit of the TPCODL.

##### **18.2 Geographical Data**

Doc. Title	<b>GENERAL CONDITIONS OF CONTRACT - COMPOSITE WORKS</b>	
Rev. No	0	Page 26 of 104

Maps, layouts and photographs of the unit/plant including its surrounding regions showing vital installation for national security of country or those of TPCODL shall not be published or disclosed to the third parties or taken out of the country without prior written approval of the TPCODL and upon execution of confidentiality agreements satisfactory to the TPCODL with such third parties prior to disclosure.

### **18.3 Associate's Processes**

Title to secret processes if any developed by the Associate on an exclusive basis and employed in the design of the equipment shall remain with the Associate. TPCODL shall hold in confidence such processes and shall not disclose such processes to the third parties without prior approval of the Associate and execution by such third parties of secrecy agreements satisfactory to the Associate prior to disclosure. Upon completion of contract, such processes shall become the property of the TPCODL. Title to technical specifications, drawings, flow sheets, norms, calculations, diagrams, interpretations of test results, schematics, layouts and such other information, which the Associate has supplied to the TPCODL under the Contract shall be passed on to the TPCODL. The TPCODL shall have the right to use these for construction, erection, start-up, Trial Run, operation, maintenance, modifications and/or expansion of the works including for the manufacture of spare parts.

### **18.4 Exclusions**

The provision of Clauses 16.1 to 16.3 shall not apply to information:

- Which at the time of disclosure are in the public domain which later on become part of public domain through no fault of the party concerned, or
- Which were in the possession of the party concerned prior to disclosure to him by the other party, or
- Which were received by the party concerned after the time of disclosure without restriction on disclosure or use, from a third party who did not acquire such information directly or indirectly from the other party or has no obligation of confidentiality for such information.

### **18.5 Violation**

In case of violation of this clause, the Associate is liable to pay compensation and damages as may be determined by the competent authority of TPCODL.

## **19.0 INTELLECTUAL PROPERTY RIGHTS**

If, in the course of performance of its functions and duties as envisaged by the scope of the present GCC, the Associate acquires or develops, any unique knowledge or information which would be covered, or, is likely to be covered within the definition of a trademark, copyright, patent, business secret, geographical indication or any other form of intellectual property right, it shall be obliged, under the terms of this present GCC, to share such knowledge or information with the TPCODL. All rights, with respect to, or arising from such intellectual property, as afore mentioned, shall solely vest in TPCODL.

Moreover, the Associate undertakes not to breach any intellectual property right vesting in a third party/parties, whether by breach of statutory provision, passing off, or otherwise. In the event of any such breach, the Associate shall be wholly liable to compensate, indemnify or make good any loss suffered by such third party/parties, or any compensation/damages



Doc. Title	GENERAL CONDITIONS OF CONTRACT - COMPOSITE WORKS	
Rev. No	0	Page 27 of 104

arising from any legal proceeding/s, or otherwise. No liability of TPCODL shall arise in this respect, and any costs, damages, expenses, compensation payable by TPCODL in this regard to a third party/parties, arising from a legal proceeding/s or otherwise, shall be recoverable from the Associate.

## 20.0 INDEMNITY

The Associate shall at all times indemnify, keep indemnified and hold harmless the TPCODL and its officers, directors, employees, affiliates, agents, successors and assigns against all actions, claims, demands, costs, charges and expenses arising from or incurred by reason of any infringement of patent, trade mark, registered design, copy rights and/or industrial property rights by manufacture, sale or use of the equipment supplied by the Associate whether or not the TPCODL is held liable for by any court judgement. In this connection, the TPCODL shall pass on all claims made against him to the Associate for settlement.

The Associate assumes responsibility for and shall indemnify and save harmless the TPCODL from all liability, claims, costs, expenses, taxes and assessments including penalties, punitive damages, attorney's fees and court costs which are or may be required to be paid by the TPCODL and its officers, directors, employees, affiliates, agents, successors and assigns arising from any breach of the Associate's obligations under the Contract or for which the Associate has assumed responsibilities under the Contract including those imposed under any local or national law or laws, or in respect to all salaries, wages or other compensation for all persons employed by the Associate or his Sub-Associates or suppliers in connection with the performance of any work covered by the Contract. The Associate shall execute, deliver and shall cause his Sub-Associate and suppliers to execute and deliver, such other further instruments and to comply with all the requirements of such laws and regulation as may be necessary there under to conform and effectuate the Contract and to protect the TPCODL.

The TPCODL shall not be held responsible for any accident or damages incurred or claims arising, due to the Associate's error there from prior to completion of work. The Associate shall be liable for such accidents and after completion of work for such accidents as the case may be due to negligence on his part to carry out Work in accordance with Indian laws and regulations and the specifications set forth herein.

## 21.0 LIABILITY & LIMITATIONS

### 21.1 Liability

Except for any specific liability which may be identified in the Contract and which may be payable hereunder, Associate shall not be liable for any special, incidental, indirect, or consequential Damages or any loss of business Contracts, revenues or other financial loss (or equivalents thereof no matter how claimed, computed or characterized) arising out of or in connection with the Performance of the Work or supply of Goods ***unless caused by Associate's negligence, willful misconduct or breach of contract.***

TPCODL shall have no liability or any special, incidental, indirect or consequential Damages for any loss of Business Contracts, revenues or other financial loss arising out of this Contract.

### 21.2 Limitation of Liability

Doc. Title	GENERAL CONDITIONS OF CONTRACT - COMPOSITE WORKS	
Rev. No	0	Page 28 of 104

The total liability of Associate against any contract shall be limited to the Total All Inclusive Contract Value.

## **22.0 FORCE MAJEURE**

Force Majeure applies if the performance by either Party ("the Affected Party") of its obligations under Contract is materially and adversely affected.

"Force Majeure" shall mean any event or circumstance or combination of events or circumstances referred below and their consequences that wholly or partly prevents or unavoidably delays any Party in the performance of its obligations under this Agreement, but only and to the extent that such events and circumstances are not within the reasonable control, directly or indirectly, of the Affected Party and could not have been avoided even if the Affected Party had taken reasonable care:

- Act of war (whether declared or undeclared), invasion, armed conflict or act of foreign enemy, embargo, blockade, revolution, riot, bombs, religious strife or civil commotion, etc.
- Politically motivated sabotage, or terrorism, etc.
- Action or Act of Government or Governmental agency for which remedy is beyond the control of the affected parties.
- Any act of God.

Note: Causes like power breakdown/ shortages/fire/strikes, accidents etc do not fall under Force Majeure.

Time being the essence of the Contract, if either party is prevented from the performance of its obligations in whole or in part due to an event of Force Majeure, then provided Notice of happening of any event by the Affected Party is given to the other party within seven (7) days from the date of occurrence of such event, which DIRECTLY has impact on works and submitted details and quantum of resulting effect, but at the same time had made all possible efforts to mitigate and overcome effects thereof, the Affected Party's performance under this Contract shall be suspended until such event ceases and the Scheduled Completion shall be delayed accordingly.

If Force Majeure event(s) continue for a period of more than three months, the parties shall hold consultation to discuss the further course of action.

Neither party shall be considered to be in default or in breach of its obligation under the Contract to the extent that performance of such obligation by either party is prevented by any circumstances of Force Majeure which arise after effective date of Contract.

Neither party can claim any compensation from the other party on account of Force Majeure.

## **23.0 SUSPENSION OF CONTRACT**

### **23.1 Suspension for Convenience**

TPCODL may, at any time and at its sole option, suspend execution of all or any portions of the schedule of items of contract to be supplied/work to executed by Associate under the contract by providing to the Associate atleast two business days written notice for contracts having contract completion period less than sixty days and atleast seven business days' notice for all other contracts.

Doc. Title	<b>GENERAL CONDITIONS OF CONTRACT - COMPOSITE WORKS</b>	
Rev. No	0	Page 29 of 104

Upon receipt of any such notice, the Associate shall respond as follows as applicable as per contract construction.

- Immediately discontinue further supply of material/goods specified in the suspension notice for supply contracts
- Immediately discontinue further service/work and supply of materials of those services/materials/work specified in the suspension notice for service /composite contract
- Promptly make every reasonable effort to obtain suspension, upon terms satisfactory to TPCODL, of all orders, outsourcing arrangements, and rental Contracts to the extent that they relate to performance of the portion of Work suspended by the notice.
- Protect and maintain the portion of the service/Work already completed, including the portion of the Work suspended hereunder, unless otherwise specifically stated in the notice.
- Continue delivering/carrying out the supply/service/work items as per contract conditions, which do not fall under purview of the suspension notice.

On receipt of resumption notice from TPCODL, the Associate shall resume execution of contract as specified in the resumption notice, within the time frame specified in the resumption notice,

### **23.2 Suspension for Breach of Contract conditions.**

TPCODL shall suspend execution of whole/or part thereof the contract till such time Associate complies with the conditions stipulated under section clause 27 for breach/default of contract conditions.

### **23.3 Compensation in lieu of Suspension**

If the suspension of the contract in whole or in part is for convenience of TPCODL and not due to any breach of contract conditions by the associate, TPCODL at its discretion shall consider compensating all reasonable additional costs incurred by Associate in lieu of suspension of whole or part of contract, on representation of the Associate providing justified estimates of such additional costs and such estimates are found acceptable and approved by competent authority of TPCODL.

If the suspension of contract in whole or part thereof is due to breach of contract conditions (refer clause 24.3) by the Associate, Associate shall not be entitled for any compensation for any cost incurred in lieu of suspension of whole or part of contract and also shall be liable for compensating all the losses arising to TPCODL in lieu of suspension of contract. Resumption notice shall be subject to the Associate taking corrective action for the breach of contract conditions within the time frame and as per the terms specified in the suspension notice.

## **24 TERMINATION OF CONTRACTS**

### **24.1 Termination for Default/Breach of Contract**

The contract / PO shall be subject to termination by TPCODL in case of breach of the contract by the Associate which shall include but not be limited to the following:

Doc. Title	GENERAL CONDITIONS OF CONTRACT - COMPOSITE WORKS	
Rev. No	0	Page 30 of 104

- a. Withdrawal or intimation by the Associate of its intent to withdraw or surrender the execution / completion of the contracted work /PO or failure in ensuring adherence to any delivery schedules, in deviation of the contract/ PO.
- b. Refusal or neglect on the part of the Associate to supply material/equipment of quantity or quality as specified by TPCODL and within the timeframe as specified in the contract document or refusal or neglect to execute the services/work in terms of the agreed standards of quantity or quality and/or within the timeframe specified in the contract/PO.
- c. Failure in any respect to perform any portion of the Work contracted with promptness, diligence, or in accordance with the terms of the contract.
- d. Failure to furnish guarantees as specified and /or failure to comply with the terms thereof.
- e. Failure to furnish such relevant documents or information within the time specified which may be necessary for due execution / completion of the works and documentation.
- f. Liquidation, bankruptcy either voluntary or involuntary OR entering into any composition or compromise with its creditors, or Insolvency.
- g. In case any reasonable information has been received by TPCODL that Associate has adopted/ or attempted to adopt any unethical conduct, action in award of the contract /PO or at any time thereafter.
- h. Failure to comply with applicable statutory provisions as contained in the contract or failure to comply with the applicable laws.
- i. Failure to comply with safety regulations/clauses stipulated in the contract or as may be generally instructed by TPCODL.

If the default or breach as specified under clause 24 (except sub clause g thereof) be committed by the associate for the first time, TPCODL shall issue, along with notice of default or breach, a warning notice instructing the associate to take remedial/corrective action within the time frame stipulated in the warning notice and not to repeat the same in future. The timeframe for corrective action by the associate shall be specific to the nature of breach of contract and the same shall not be objected to by the Associate. If the Associate fails to comply with the instructions in the warning notice or in taking corrective action to the satisfaction of TPCODL then TPCODL may terminate the entire or part of contract at its discretion by issuing termination notice without incurring any liability on this ground.

In case the contract is terminated for any breach of the nature specified in clause 24 g stated above, TPCODL shall have the right to terminate all the contracts TPCODL is having with the Associate by issuing termination notice which shall be without prejudice to the other rights of TPCODL available to it under law.

Without prejudice to its right to terminate for breach of contract, TPCODL may, without assigning any reason, terminate the Contract in whole or in part at any time at its discretion while the contract is in force by serving a written notice of two weeks to the Associate.

In the event of TPCODL having proceeded with termination of the contract the associate shall comply and proceed further in the following manner:

- i) Associate shall discontinue the supply, on the expiry of the said period of two weeks.

Doc. Title	GENERAL CONDITIONS OF CONTRACT - COMPOSITE WORKS	
Rev. No	0	Page 31 of 104

ii) Associate shall ensure that no further steps are being taken towards discharge of the obligations, terms and conditions as contained in the contract/PO. This shall include initiation of actions not limited to discontinuation of other allied and associated arrangements which the associate might have entered into with third parties for due discharge of its obligations under the contract with TPCODL.

iii) The Associate shall perform thereafter such tasks as may be necessary to preserve and protect the terminated portion of the material/service/work in progress and the materials and equipment at TPCODL sites or in transit thereto. However the associate shall continue to fulfill its contractual obligations with regard to the part of contract not terminated.

iv) It shall be open for TPCODL to conduct a joint assessment with the associate of the material ,supplies, equipment ,works or in general as to the subject matter of the contract in regard to which the associate claims having completed its obligations before or during such termination.

v) It shall be open to TPCODL to seek invocation of the performance bank guarantee or any other guarantee or other security deposit by whatever name called submitted by the associate, which shall not be objected to or protested against by the associate.

In case of termination of the contract the parties agree to be governed inter alia by the following:

a) In case TPCODL exercises its right of termination as stated above the associate shall not dispute or object to the same.

b) The Associate shall be entitled to receive and claim only such payments OR sums of money from TPCODL as may be found payable to it in regard to works executed by it under the terms of the contract and no other claim of any nature whatsoever shall be made by the Associate.

c) All such provisions which the parties have agreed to survive and prevail even after termination of the contract shall remain effective despite the termination.

In the event of such termination, TPCODL may finish the Work by whatever method it may deem expedient, including the hiring of services and /or purchase of material equipment from such third parties as TPCODL may deem fit or may itself provide any labor or materials and perform any part of the Work. The associate undertakes to bear the incremental costs if any paid by TPCODL in such a case attributable to failure on the part of the associate. The Associate in such a case shall not be entitled to receive any further payments and any sums found payable to it may be adjusted by TPCODL against the amount recoverable from him on this ground. The same shall be without prejudice to other rights available to TPCODL under law against the associate.

Upon the termination of any of the contract due to occurrence of any circumstances provided in clauses stated above and constituting repeated breach or misconduct , TPCODL shall be entitled to bar the associates its agents , affiliates from undertaking any negotiation / tendering, bidding, participation activities concerning TPCODL for a period of two years from date of such termination. The same shall be without prejudice to other rights available to TPCODL.

#### **24.2 Termination for convenience of Associate**

Doc. Title	<b>GENERAL CONDITIONS OF CONTRACT - COMPOSITE WORKS</b>	
Rev. No	0	Page 32 of 104

Associate at its convenience may request for termination of contract, clearly assigning the reason for such request. TPCODL has full right to accept, reject or partially accept such request. This convenience will be available to associate only after one year from the contract effective date. For this purpose, associate will provide a notice period of 90 days to TPCODL, Associate will have to pay TPCODL a 'termination convenience fee' equivalent to 5% of unexecuted contract value.

### **24.3 Termination for Convenience of TPCODL**

TPCODL at its sole discretion may terminate the contract by giving 30 days prior notice in writing or through email to the Associate. TPCODL shall pay the Associate for all the supplies/ services rendered till the actual date of contract termination against submission of invoice by the Associate to that effect.

### **25.0 DISPUTE RESOLUTION & ARBITRATION**

In case of any dispute or difference the parties shall endeavor to resolve the same through conciliatory and amicable measures within 15 Days failing which the matter may be referred by either party for resolution by the sole arbitrator to be appointed mutually by both the parties. The arbitral proceedings shall be conducted in accordance with Arbitration and Conciliation Act 1996 and the place of arbitration shall be Bhubaneswar. The language to be used at proceedings shall be English and the award of the arbitrator shall be final and binding on the parties. The parties shall bear their respective costs of arbitration. The associate shall continue to discharge its obligations towards due performance of the works as per the terms of the contract during the arbitration proceedings unless otherwise directed in writing by TPCODL or suspended by the arbitrator. Further, TPCODL shall continue making such payments as may be found due and payable to the associate for such works.

#### **25.1 Governing law and jurisdiction**

The parties shall be subject to the jurisdiction of the courts of law in Bhubaneswar and any matter arising here from shall be subject to applicable law in force in India.

### **26.0 ATTRIBUTES OF GCC**

#### **26.1 Cancellation**

The Company reserves the right to cancel, add, delete at its sole discretion, all or any terms of this GCC or any contract, order or terms agreed between the parties in pursuance without assigning any reasons and without any compensation to the Associates.

#### **26.2 Severability**

If any portion of this GCC is held to be void, invalid, or otherwise unenforceable, in whole or part, the remaining portions of this GCC shall remain in effect.

#### **26.3 Order of Priority**

In case of any discrepancies between the stipulations in General Conditions of the Contract (GCC) and Special Conditions of Contract (SCC), the GCC shall stand superseded by the SCC to the extent stipulated hereinabove while balance portion of respective clauses of GCC shall continue to be applicable.

### **27.0 INSURANCE**

Doc. Title	<b>GENERAL CONDITIONS OF CONTRACT - COMPOSITE WORKS</b>	
Rev. No	0	Page 33 of 104

The Associate shall arrange accident insurance policy for his foreign experts/specialists/personnel deputed to Site and Associate's/his sub-Associates' manufacturing works as well as for his Indian engineers and supervisory staff. The Associate shall also take out for his Indian workmen, where applicable, a separate policy as required under Workmen's Compensation Act.

Associates shall be responsible to suitably insure their entire work-force (to the extent of at least meeting requirements under Workmen Compensation Act) Tools, Plant, Third party liability at the project site, All Risk comprehensive insurance for the entire works (insurance for free issue items will be in TPCODL scope) for total contract (PO/RO) value or any other such risks during execution of works, till the works are handed over to the company, in consultation with TPCODL and shall submit copies of such insurances to the Engineer-in-Charge for review / acceptance before commencing the work. Engineer-in-charge must ensure compliance to insurance requirement by Associate before commencement of works. TPCODL shall stand fully indemnified in this respect.

### **28.0 ERRORS AND OMISSIONS**

The Associate shall be responsible for all discrepancies, errors and omissions in the drawings, documents or other information submitted by him, irrespective of whether these have been approved, reviewed or otherwise accepted by the TPCODL or not. However any error in design/drawing arising out of any incorrect data/written information from TPCODL will not be considered as error and omissions on part of the Associate.

### **29.0 TRANSFER OF TITLES**

The title of ownership and property to all equipment, installations, erections, constructions materials, drawings & documents shall pass to the TPCODL after Commissioning and complete handing over-taking over.

However, such passing of title of ownership and property to the TPCODL shall not in any way absolve, dilute or diminish the responsibility and obligations of the Associate under this Contract including loss or damages and all risks, which shall vest with the Associate.

The Associate shall take all corrective measures arising out of discrepancies, errors and omissions in drawings and other information within the time schedule and without extra cost to the TPCODL.

The Associate shall also be responsible for any delay and/or extra cost if any, in carrying out engineering, and site works by other agencies arising out of discrepancies, errors and omissions stated in as well as of any late revision/s of drawings and information submitted by the Associate.

### **30.0 SUGGESTIONS & FEEDBACK**

We welcome all our Business Associates to write to us about their experience with TPCODL; be it our Company, our services or our people. Each and every concern, issue, query and suggestion from you will help us to become a better company to work with and shall help us develop a strong bonding of trust and a long term relationship with you.

You may send your feedback by filling up our Business Associate Feedback Form enclosed herewith as Annexure-I. You can also log on to our website [www.tpcentralodisha.com](http://www.tpcentralodisha.com) to provide your feedback according to the guidelines mentioned below:

Doc. Title	GENERAL CONDITIONS OF CONTRACT - COMPOSITE WORKS	
Rev. No	0	Page 34 of 104

### 31.0 CONTACT POINTS

In case Business Associate needs information with respect to payments or has any grievances, same may be lodged by log on to our website [www.tpcentralodisha.com](http://www.tpcentralodisha.com)

### 32.0 LIST OF ANNEXURES

S. No.	Subject	Annexure
1.	Performa for Bid Security Bank Guarantee	A
2.	Performa for Advance Payment Bank Guarantee	B
3.	Performa for Performance Bank Guarantee (CP cum EP)	C
4.	Performa for No Demand Certificate by Associate	D
5.	Performa for Indemnification on Statutory Compliance	E
6.	Performa For Application For Issuance of Consolidated TDS Certificate	F
7.	HR Service Level Agreement	G
8.	Under taking for competence of workmen	H
9.	Business Associate Feedback Form	I
10.	Acceptance Form For Participation In Reverse Auction Event	J
11.	NEFT or RTGS payment request form	K
12.	Contractor Safety Management System	L
13.	Vendor Appraisal Form	M
14.	Manufacturers Authorization Form	N



Doc. Title	GENERAL CONDITIONS OF CONTRACT - COMPOSITE WORKS	
Rev. No	0	Page 35 of 104

**ANNEXURE-A**

**PROFORMA FOR BID SECURITY BANK GUARANTEE**

**TP Central Odisha Distribution Limited**

**Bhubaneswar**

WHEREAS, (Name of the Bidder) \_\_\_\_\_ (hereinafter called "the BIDDER") has submitted his bid dated \_\_\_\_\_ for the (Name of Contract) \_\_\_\_\_ (hereinafter called "the BID").

KNOW ALL men by these presents we (Name of the Bank) \_\_\_\_\_ of (Name of the Country) \_\_\_\_\_ having our registered office at \_\_\_\_\_ (hereinafter called "the BANK) are bound unto TP Central Odisha Distribution Limited (TPCODL) in the sum of \_\_\_\_\_ for which payment well and truly to be made to the TPCODL the Bank binds himself, his successors and assigns by these presents.

SEALED with the Common Seal of the said Bank this \_\_\_\_\_ day of \_\_\_\_\_ 20\_\_\_\_\_.

The CONDITIONS of this obligation are:

i) If the Bidder withdraws his Bid during the period of bid validity specified in the Proforma of Bid

or

ii) If the Bidder having been notified of the acceptance of his Bid by the TPCODL during the period of bid validity fails or refuses to furnish the Contract Performance Bank Guarantee, in accordance with the Instructions to Bidders.

We undertake to pay the TPCODL upto the above amount upon receipt of its first written demand, provided that in its demand the TPCODL will note that amount claimed by it is due to it owing to the occurrence of one or both conditions, specifying the occurred condition or conditions.

This Guarantee will remain in force upto and including the date (No of days as mentioned in tender enquiry) days after the closing date of submission of bids as stated in the Invitation to Bid or as extended by you at any time prior to this date, notice of which extension to the Bank being hereby waived, and any demand in respect thereof should reach the Bank not later than the above date.

**DATE**.....

**SIGNATURE**

**OF**

**THE**

**BANK**.....

**WITNESS**.....

**SEAL**.....

(Signature, Name & Address)

(At least 2 witnesses)

Doc. Title	GENERAL CONDITIONS OF CONTRACT - COMPOSITE WORKS	
Rev. No	0	Page 36 of 104

**ANNEXURE-B**

**PROFORMA FOR ADVANCE PAYMENT BANK GUARANTEE**

**(On Rs.100/- Stamp Paper)**

**Note:**

- (a) Format shall be followed in toto
- (b) Claim period of six months must be kept up
- (c) The guarantee to be accompanied by the covering letter from the bank confirming the signature to the guarantee

-----  
-----

**TP Central Odisha Distribution Limited**

**Bhubaneswar**

**Advance Payment B.G.No.....**

**Contract No.....dated.....**

1. You have entered into a Contract No \_\_\_\_\_ with M/s. \_\_\_\_\_ (hereinafter referred to as "the Vendor") for the supply and delivery of \_\_\_\_\_ (hereinafter referred to as "the said Equipment") for the price and on the terms and conditions contained in the said contract.
2. In accordance with the terms of the said contract, you have agreed to make an advance payment of Rs. \_\_\_\_\_ (Rupees \_\_\_\_\_ only) being \_\_\_\_\_% (\_\_\_\_\_percent) of the total value of the contract on "the Vendor" furnishing you with an irrevocable, unconditional and acceptable bank guarantee to be valid till the date of receipt of "the said equipment" covered by your above mentioned contract. For this purpose you have agreed to accept our guarantee.
3. In consideration thereof, we, \_\_\_\_\_ hereby irrevocably and unconditionally guarantee to pay to you on demand but in any case before the end of five working days from the date of the claim and without demur and without reference to "the Vendor" such amount or amounts not exceeding the sum of Rs. \_\_\_\_\_ (Rupees \_\_\_\_\_ only) being \_\_\_\_\_% (\_\_\_\_\_percent) of the total value of the contract on receipt of your intimating that "the Vendor" has not fulfilled his contractual obligations. You shall be the sole judge for such non-fulfillment and "the Vendor" shall have no right to question such judgment.
4. You shall have the right to file / make your claim on us under the guarantee for a further period of one months from the date of expiry.
5. This guarantee shall not be revoked without express consent and shall not be affected by your granting time or any other indulgence to "the Vendor", which shall include but

Doc. Title	GENERAL CONDITIONS OF CONTRACT - COMPOSITE WORKS	
Rev. No	0	Page 37 of 104

not be limited to, postponement from time to time of the exercise the same in you or any right which you may have against "the Vendor" and to exercise the same in any covenant contained or implied in the said contract or any other course or remedy or security available to you, and our Bank shall not be released from its obligations under this guarantee by your exercising any of your rights with reference to matters aforesaid or any of them or by reasons of any other act or forbearance or other acts of omission or commission on your part or any other indulgence shown by you or by any other matter or thing whatsoever which under the law would, but for this provision have the effect of relieving our bank from its obligation under this guarantee.

6. We also agree that you shall be entitled at your option to enforce this guarantee against our bank as a principal debtor, in the first instance, notwithstanding any other security or guarantee that you may have in relation to "the Vendor's" liabilities in respect of the premises
7. This guarantee shall not be affected by any change in the constitution of our Bank or "the Vendor" or for any other reason whatsoever.
8. Any claim / extension under the guarantee can be lodge-able at outstation banks or at Bhubaneswar branch and claim will also be payable at Bhubaneswar Branch **(to be confirmed by Bhubaneswar Branch by a letter to that effect)**
9. Notwithstanding anything herein contained, our liability under this guarantee is limited to Rs. \_\_\_\_\_ (Rupees \_\_\_\_\_ only) and the guarantee will remain in force upto and including \_\_\_\_\_ (Date) and shall be extended from time to time for such period or period as may be desired by "the Vendor".
10. Unless a demand or claim under this guarantee is received by us in writing within one month from \_\_\_\_\_ (expiry date) i.e. on or before \_\_\_\_\_ (claim period end date), we shall be discharged from all liabilities under this guarantee thereafter.

Dated at \_\_\_\_\_ this \_\_\_\_\_ day of \_\_\_\_\_ 200 \_\_\_\_\_

**Witness**

- |          |  |
|----------|--|
| 1. _____ | Bank's rubber stamp<br>Banks full address        |
| 2. _____ | Designation of Signatory<br>Bank official number |

Doc. Title	GENERAL CONDITIONS OF CONTRACT - COMPOSITE WORKS	
Rev. No	0	Page 38 of 104

**ANNEXURE- C**

**PROFORMA FOR PERFORMANCE BANK GUARANTEE (CP cum EP)**

**(On Rs.100/- Stamp Paper)**

**Note:**

- (a) Format shall be followed in toto
- (b) Claim period of one month must be kept up
- (c) The guarantee to be accompanied by the covering letter from the bank confirming the signature to the guarantee

-----  
-----

**TP Central Odisha Distribution Limited**

**Bhubaneswar**

**CP cum EP BG No.....**

**Order/Contract No.....dated.....**

1. You have entered into a Contract No \_\_\_\_\_ with M/s. \_\_\_\_\_ (hereinafter referred to as "the Vendor") for the supply cum erection / civil work of \_\_\_\_\_ (hereinafter referred to as "the said Equipment") for the price and on the terms and conditions contained in the said contract.
2. In accordance with the terms of the said contract, "the Vendor" agreed to furnish you with an irrevocable, unconditional and acceptable bank guarantee for 10% of the value of contract and to be valid till the end of Guarantee period plus one month towards "Contract cum Equipment performance". For this purpose you have agreed to accept the guarantee.
3. In consideration thereof, we, \_\_\_\_\_ hereby irrevocably and unconditionally guarantee to pay to you on demand but in any case before the end of five working days from the date of the claim and without demur and without reference to "the Vendor" such amount or amounts not exceeding the sum of Rs. \_\_\_\_\_ (Rupees \_\_\_\_\_ only) being \_\_\_\_\_ % (\_\_\_\_\_ percent) of the total value of the contract on receipt of your intimating that "the Vendor" has not fulfilled his contractual obligations. You shall be the sole judge for such non-fulfillment and "the Vendor" shall have no right to question such judgment.
4. You shall have the right to file / make your claim on us under the guarantee for a **further period of one month** from the date of expiry.
5. This guarantee shall not be revoked without express consent and shall not be affected by your granting time or any other indulgence to "the Vendor", which shall include but not be limited to, postponement from time to time of the exercise the same in you or any right which you may have against "the Vendor" and to exercise the same in any covenant contained or implied in the said contract or any other course or remedy or security

Doc. Title	GENERAL CONDITIONS OF CONTRACT - COMPOSITE WORKS	
Rev. No	0	Page 39 of 104

available to you, and our Bank shall not be released from its obligations under this guarantee by your exercising any of your rights with reference to matters aforesaid or any of them or by reasons of any other act or forbearance or other acts of omission or commission on your part or any other indulgence shown by you or by any other matter or thing whatsoever which under the law would, but for this provision have the effect of relieving our bank from its obligation under this guarantee.

6. We also agree that you shall be entitled at your option to enforce this guarantee against our bank as a principal debtor, in the first instance, notwithstanding any other security or guarantee that you may have in relation to "the Vendor's" liabilities in respect of the premises
7. This guarantee shall not be affected by any change in the constitution of our Bank or "the Vendor" or for any other reason whatsoever.
8. Any claim / extension under the guarantee can be lodge-able at outstation banks or at Bhubaneswar branch and claim will also be payable at Bhubaneswar Branch (to be confirmed by Bhubaneswar Branch by a letter to that effect in case BG is from the branch outside Bhubaneswar)
9. Notwithstanding anything herein contained, our liability under this guarantee is limited to Rs. \_\_\_\_\_ (Rupees \_\_\_\_\_) only and the guarantee will remain in force upto and including \_\_\_\_\_ (Date) and shall be extended from time to time for such period or period as may be desired by "the Vendor".
10. Unless a demand or claim under this guarantee is received by us in writing within one months from \_\_\_\_\_ (expiry date) i.e. on or before \_\_\_\_\_ (claim period end date), we shall be discharged from all liabilities under this guarantee thereafter.

Dated at \_\_\_\_\_ this \_\_\_\_\_ day of \_\_\_\_\_ 200\_\_

**Witness**

- |          |  |
|----------|--|
| 1. _____ | Bank's rubber stamp<br>Banks full address        |
| 2. _____ | Designation of Signatory<br>Bank official number |

Doc. Title	GENERAL CONDITIONS OF CONTRACT - COMPOSITE WORKS	
Rev. No	0	Page 40 of 104

**ANNEXURE-D**

**PROFORMA FOR “NO DEMAND CERTIFICATE” BY ASSOCIATE**

(On Company’s Letter head or with Company Seal)

(To be submitted by the Associate to TPCODL Accounts Department at the time of receipt of full and final payment)

**(Certificate No. CCP/002)**

Name of the Project

Order/ Contract No.

Dated

Name of the Associate

Scheme No. / Job No.

We, M/s. \_\_\_\_\_ (Associate) do hereby acknowledge and confirm that we have received the full and final payment due and payable to us from TPCODL, in respect of our aforesaid Order No \_\_\_\_\_ dated \_\_\_\_\_ including amendments, if any, issued by TPCODL to our entire satisfaction and we further confirm that we have no claim whatsoever pending with TPCODL under the said contract / W.O.

Notwithstanding any protest recorded by us in any correspondence, documents, measurement books and / or final bills etc., we waive all our rights to lodge any claim or protest in future under this contract.

We are issuing this “NO DEMAND CERTIFICATE” in favour of TPCODL, with full knowledge and with our free consent without any undue influence, misrepresentation, coercion etc.

**Dated**

**Signature**

**Place**

**Name**

**Designation**

**(Company Seal)**

Doc. Title	GENERAL CONDITIONS OF CONTRACT - COMPOSITE WORKS	
Rev. No	0	Page 41 of 104

**ANNEXURE – E**

**PROFORMA FOR “INDEMNIFICATION ON STATUTORY COMPLIANCES”**

(To be submitted by the successful Bidder within seven days of award of work)

**(Certificate No. CCP/001)**

Name of the Project

Letter of Award / Contract No.

Dated

Name of the Associate

Scheme No. / Job No.

By this confirmation we, \_\_\_\_\_  
(Associate) are formally bound to M/s. TPCODL towards any sum which may be imposed, levied or hereinafter recovered by the Provident Fund Organization under the provisions of the Employees of the Provident Fund and Miscellaneous Provisions Act 1952 in respect of employees employed by us.

We well and truly bind ourselves and our heirs executors administrators and representatives jointly severally and respectively for the above payment only to be paid to M/s. TPCODL.

AND WHEREAS we, \_\_\_\_\_ (Associate) is making compliance of the Employees Provident Fund and Miscellaneous Provisions Act 1952, have entered into the above written bond for the indemnity to M/s. TPCODL against all losses from the acts or default of the said Associate in respect of compliance of the Provident Fund Act.

Similarly we hereby confirm that we have complied with all statutory and local laws and nothing is outstanding with regard to Local Sales Tax, Labour Laws, Local Municipal dues, Electricity dues etc. We have entered into the above written bond for the indemnity to M/s. TPCODL against all losses from the acts or default of the said Associate in respect of compliance of the Local Sales Tax Laws, Local Laws, Labour Laws, Local Municipal Dues, Electricity dues etc.

NOW THE CONDITION, of the above written bond is as such that if the Associate during the period of this contract commits any default or fails to make payment of Contributions in respect of his employees to the Employees Provident Fund Organization, he shall indemnify the Principal Employer M/s. TPCODL from all and every loss and damage caused to them from any act, omissions or negligence of the said Associate in respect of compliances under the Employees Provident Fund and Miscellaneous Provisions Act, 1952.

IN WITNESS to the above written bond we have here to set our hands, with our free consent.

**Dated**

**Signature**

**Place**

**Name**

**Designation (Company Seal)**

Doc. Title	GENERAL CONDITIONS OF CONTRACT - COMPOSITE WORKS	
Rev. No	0	Page 42 of 104

**ANNEXURE-F**

**PROFORMA FOR APPLICATION FOR ISSUANCE OF CONSOLIDATED TDS  
CERTIFICATE**

To be printed on the letterhead

To,

TP Central Odisha Distribution Limited,

Bhubaneswar

**Sub: Application for issuance of Consolidated TDS Certificate for the FY \_\_\_\_\_**

Dear Sir,

I / we hereby request / authorize you to issue me / us a consolidate TDS Certificate for the financial year \_\_\_\_\_ against tax deducted at source by you from my / our payments / bills during the said year from time to time under Chapter XVII – B of the Income Tax Act, 1961.

For and on behalf of

Signature

Name

Address

Contact No. (Land Line)

(Mobile)

PAN #

Assessing authority

**ATTACH THE COPY OF PAN CARD**



Doc. Title	GENERAL CONDITIONS OF CONTRACT - COMPOSITE WORKS	
Rev. No	0	Page 43 of 104

## ANNEXURE - G

### SERVICE LEVEL AGREEMENT

(To be adhered to by Business Associates (BAs) in TPCODL on Human Resource Issues)

**1.0 The following shall be adhered to by the Business Associates during his / its association with TPCODL:**

**Shall Abide by TPCODL Core Values:**

- a) **Integrity** – We must conduct our business fairly, with honesty and transparency. Everything we do must stand the test of public scrutiny.
- b) **Understanding** – We must be caring, show respect, compassion and humanity to our colleagues and customers and always work for the benefit of the communities we serve.
- c) **Excellence** – We must constantly strive to achieve the highest possible standards in our day to day work and in the quality of services we provide.
- d) **Unity** – We must work cohesively with our colleagues across the group and with our customers and partners to build strong relationships based on tolerance, understanding and mutual co-operation.
- e) **Responsibility** – We must continue to be responsible and sensitive to the communities and environments in which we work and always ensuring that what comes from the people; goes back to the people many times over.
- f) **Agility**- We must work in a speedy and responsive manner and be proactive and innovative in our approach.

**2.0 The Business Associate / his manager / supervisor who is responsible for managing the project site / performance contract etc. in TPCODL would also ensure adherence of these values by his employees / persons deployed by him in connection with his works undertaken in TPCODL.**

**3.0 TPCODL is a signatory to the United Nation Global Compact as an integral part of its Governance principles / business. The Business Associates are required to:**

- a) Support and respect the protection of human rights and make sure that they are not complicit in human right abuses.
- b) Respect freedom of association and effective recognition of the right to collective bargaining.
- c) Not to resort to any form of forced and compulsory labour.
- d) Shall ensure abolition of child labour in his area of work.
- e) There is no discrimination in respect of employment and occupation in respect of his employees.
- f) Support precautionary approach to environmental challenges.
- g) Promote greater environmental responsibility by himself and his employees in his areas of work.
- h) Deploy and defuse environmental friendly technologies while carrying out the works.
- i) Work against corruptions in all its form including extortion and bribery by himself and his employees.

**4.0 The Business Associates are required to adhere to all applicable Labour Laws with special reference to the following:**

Doc. Title	GENERAL CONDITIONS OF CONTRACT - COMPOSITE WORKS	
Rev. No	0	Page 44 of 104

- a) No person below the age of 18 years and no child labour will be engaged directly or indirectly for executing the work connected with the business of TPCODL.
- b) Minimum wages along with other statutory dues like PF, ESI, etc. as applicable to the workers shall be made within the prescribed period of 7<sup>th</sup> / 10<sup>th</sup> day of the following month.
- c) Deduction / deposit / record keeping and all other requirements under Employees PF Act 1952, Employees State Insurance Act 1948 and other applicable acts (if any) shall be adhered to.
- d) Only statutorily authorized deductions (if any) shall be made in accordance with the relevant statutes.
- e) All the provisions of Contract Labour (R&A) Act 1970 shall be complied with in respect of the workers engaged for TPCODL work. The work will be commenced only after completing necessary formalities for obtaining Labour License (if applicable).
- f) Necessary registers / records, filing of returns etc. shall be maintained for verification by Statutory / TPCODL authorities.
- g) Payment of wages shall be made only in presence of and with certification of authorized representative of TPCODL or shall be made in the form of cheque / bank transfer to the employee.
- h) During the period of contract, the Business Associate will arrange for deployment of his supervisor / manager for total supervision and control of the work and their manpower. All the activities related to their manpower e.g. attendance, leave, wage disbursement etc. will be done under the supervision & control of Business Associates, While adhering to the prescribed standard / norms of production / productivity & quality. During execution of the work, Business Associate shall engage only such qualified / skilled manpower as may be envisaged / required for ensuring level of production / service into the contract / work order.
- i) Clearances as follows shall be obtained from IR & Welfare Group:
  - i. Clearance for commencement (before start of the work).
  - ii. No Objection Certificate (after completion / before final settlement).
  - iii. Copies of PF / ESI Challans shall be deposited with IR & Welfare Group every month
- j) The Business Associate shall indemnify TPCODL from any liabilities under applicable Labour Statutes.
- k) The Business Associate shall ensure safety and health of his employees and shall also maintain hygienic working environment / condition in his area of work.
- l) The Business Associate and his employee shall abide by Laws of Land and shall not violate any applicable provisions.
- m) The Business Associate appreciates with and acquiesces to the right of TPCODL as principal employer to fulfil any of his legal obligations, if he fails to do so under applicable labour laws and deduct the same from his running bills / final payments / encashing security deposit / Bank Guarantee as the case may be. If there is any further shortfall TPCODL has the right to recover the same from the Business Associate.
- n) The Business Associate ensures that person employed by him adhere to the moral and legal conduct and shall not violate any standard conduct envisaged in the premise of

Doc. Title	GENERAL CONDITIONS OF CONTRACT - COMPOSITE WORKS	
Rev. No	0	Page 45 of 104

TPCODL by all such as, Transparency, Safety, Discipline, Integrity etc. The Business Associate or his employees should refrain from corrupt practices, giving or taking bribe in connection with any TPCODL business.

**5.0 The 'Statutory Compliance Enforcement System' in TPCODL is detailed below for adherence by all concerned. Corporate IR & Welfare Group will be the process owner for implementation of the system with the help of concerned Engineer I/c or Officer I/c.**

- a) Statutory Compliance being a professed value in TPCODL Code of Conduct, the concerned Engineer / Officer in charges are requested to adhere to the provisions and advise respective Business Associates in their domain to comply in letter and spirit.
- b) Immediately after issuance of letter of intent, the authorized representative of the Business Associate will report to Corporate IR & Welfare group for completion of statutory requirements.
- c) Normally, the work will be started only after 'Clearance for Commencement of Work (CCW)' is issued by IR & W group to the Business associate. However in exceptional exigencies in engineer I/c / Officer I/c may direct the Business Associate to start the work and inform IR & W group about the same. Statutory requirements in this case may be completed parallelly.
- d) First monthly bill will be released only after producing CCW to the finance department. Similarly closure of work and final settlement will be affected after issuance of no objection certificate from IR & W group.

**6.0 Requirements for 'Clearance for Commencement of Work' (CCW):**

- a) Submission of filled up Form 'A' for database (Annexure-1).
- b) Copy of PF Code allocation letter.
- c) Copy of ESI Code allocation letter.
- d) Submission of duly filled up Form IV CL(R&A) act (In case more than or equals to 20 workers during the period of contract).
- e) Submission of duly filled up Form VI A (Notice of Commencement).
- f) Copy of insurance cover note under WC Act 1923 (if applicable).
- g) Copy of Contract Agreement.
- h) Copy of indemnity bond (if applicable).
- i) Affidavit with regard to payment of wages through cheque / bank transfer only.

**7.0 Requirements during execution of work:**

- a) Copy of receipt of application for license / license (if applicable).
- b) Copy of PF Challan (latest by 26<sup>th</sup> day of every Month).
- c) Copy of ESI Challan (latest by 26<sup>th</sup> day of every Month).
- d) Copy of Wage disbursement sheet / Bank statement.
- e) Filing / Maintenance of all statutory registers / reports / returns for inspection by Statutory/ TPCODL authorities.
- f) Certification of wage disbursement by authorized representative of TPCODL.
- g) Copy of 'Labour Welfare Fund' deposit certificate / Challan.
- h) Insuring safe working practices at the work place.

**8.0 Requirements for 'No Objection Certificate' (NOC) for closure of work:**

- a) Submission of duly filled up Form VI A (Notice of Completion).

Doc. Title	GENERAL CONDITIONS OF CONTRACT - COMPOSITE WORKS	
Rev. No	0	Page 46 of 104

- b) Copy of Half yearly / Annual return for ESI / PF / CL(R&A).
- c) Consolidated copy of wage sheet of last month indicating full & final settlement of all dues like retrenchment benefit, bonus, leave encashment etc. Copy of individual declaration by employees in Form X regarding termination of employment.
- d) Confirmation certificate regarding filling up of form for transfer / withdrawal of PF by the concerned workers.

**In case any of the above are deviated / not complied with the Letter of Award/Order shall be liable to be withdrawn / cancelled.**

**Enclosure:**

- 1) Form A
- 2) Form X
- 3) Form XI
- 4) Form VI A
- 5) Form XXIV

GENERAL CONDITIONS OF CONTRACT

Doc. Title	GENERAL CONDITIONS OF CONTRACT - COMPOSITE WORKS	
Rev. No	0	Page 47 of 104

**FORM (A)**

**[To be submitted by the Business Associate to the Principal Employer within a week from LoA issuance]**

**A. Details of the Agency**

1. Name of Agency :
2. Nature of work :
3. Local Address with Ph.No. :  
(With Father's name) :
4. Permanent Address (Full) :
5. PF code no. & Place :
6. ESI Code no. & Place :
7. Name and address of :  
Sub-contractor (if any)

**B. Details of Work**

8. Name of work (as specified in LOI/LOA) :
9. LOI/LOA Nos. & Dates :
10. Period of contract (Specify Dates) :  
[Including Extension period, if any] :
11. Work Area [Department / Location] :
12. Name / Cell no. of Officer I/c :
13. Maximum No. of workers and staff to be engaged on any day during the year.
  - Supervisory Staff :
  - Workers :
14. Do you have any other contract in TPCODL : Yes/No  
If yes, furnish details:

Doc. Title	GENERAL CONDITIONS OF CONTRACT - COMPOSITE WORKS	
Rev. No	0	Page 48 of 104

15. Details of Workmen's compensation Policy, if applicable

Name of Insurance Company .....  
 .....Policy No ..... Number of persons covered .....  
 Period of coverage: From ..... To .....

If no, I hereby undertake the liability arising out of Workmen's Compensation Act and Rules made there under.

**C. Details of workers to be engaged**

**No. of Workers**

S. No.	Unskilled*	Semi-skilled*	Skilled*	Clerical / Supervisory

**\* Number to be indicated**

I/We shall fulfill all obligations arising from and under all relevant law in force from time to time. I/We undertake to keep the TPCODL indemnified against any loss or liability arising out of failure of my / our abiding the relevant laws.

The name of my / our representatives is ..... to enter the TPCODL Premises on my behalf.

**Date:**

**(Signature of the Business Associate  
 or his Authorized Representative)**

**This Business Associate is / will be engaged in TPCODL.**

**(Signature and seal of**

**Officer I/c of the Work)**

Doc. Title	GENERAL CONDITIONS OF CONTRACT - COMPOSITE WORKS	
Rev. No	0	Page 49 of 104

**Form X**

**Undertaking**

I \_\_\_\_\_ hereby undertake that all the dues in respect of my employment with M/s \_\_\_\_\_ for the period of \_\_\_\_\_ to \_\_\_\_\_ have been settled and final payments including retrenchment benefit have been made to me in full.

( \_\_\_\_\_ )

\_\_\_\_\_

Date:

GENERAL CONDITIONS OF CONTRACT

Doc. Title	GENERAL CONDITIONS OF CONTRACT - COMPOSITE WORKS	
Rev. No	0	Page 50 of 104

**Form XI**

**Undertaking**

With reference to the contract job awarded by M/s TP Central Odisha Distribution Limited to M/s \_\_\_\_\_ vide work order No. \_\_\_\_\_ dated \_\_\_\_\_

I \_\_\_\_\_ on behalf of

M/s \_\_\_\_\_ hereby undertake:

1. that the dues in respect of the workmen/ employee(s) engaged by us for the said contract, payable as per the provisions of relevant statute pertaining to
  - i. wages/ salary
  - ii. PF & ESI, Bhubaneswar Labour Fund
  - iii. All other statutory obligation
 has been paid /settled in full and no amount/ compliance is due/ pending.
  
2. That in case any dispute / claim is raised by the concerned workers i.r.o. any dues / payments, M/s \_\_\_\_\_ will settle the same on it's own and such liability will be borne by M/s \_\_\_\_\_
  
3. That M/s \_\_\_\_\_ hereby indemnify M/s TPCODL from any future liability i.r.o. any statutory obligation in respect of said contract.

Date:

\_\_\_\_\_  
( )

Authorized Signatory

For M/s \_\_\_\_\_



Doc. Title	GENERAL CONDITIONS OF CONTRACT - COMPOSITE WORKS	
Rev. No	0	Page 51 of 104

**FORM- VI A**

**Notice for Commencement /Completion of contract work**

I/We, Sh. / M/s \_\_\_\_\_ (Name and Address of the Contractor) hereby intimate that the contract work \_\_\_\_\_ (name of work) in establishment of the \_\_\_\_\_ (name and address of the Principal Employer) for which License No. \_\_\_\_\_ dated \_\_\_\_\_ has been issued to me/us by the Licensing Officer \_\_\_\_\_ (name of the Headquarters), has been commenced / completed with effect from \_\_\_\_\_ date / on date.

**Signature of Contractor**

**With Office Seal**

**The Inspector**

\_\_\_\_\_  
\_\_\_\_\_

**FORM XXIV**

[See Rule 82(1)]

***Return to be sent by the Contractor to the licensing Officer (in duplicate)***

Half -Yearly Ending \_\_\_\_\_

1. Name and address of the Contractor
2. Name and address of the Establishment
3. Name and address of the Principal Employer
4. Duration of Contract: From \_\_\_\_\_ to \_\_\_\_\_
5. No. of days during the half year on which
  - (a) the establishment of the principal employer had worked
  - (b) the contractor's establishment had worked
6. Maximum No. of contract labour employed on any day during the half –year:

Men	Women	Children	Total

7.
  - (i) Daily hours of work and spread over
  - (ii)
    - (a) whether weekly holiday observed and on what day
    - (b) if so, whether it was paid for
  - (iii) No. of man – hours of overtime worked

8. No. of man days worked by

Men	Women	Children	Total

9. Amount of wages paid

Men	Women	Children	Total

10. Amount of deductions from wages, if any

Men	Women	Children	Total

Whether the following have been provided –

- (i) Canteen : \_\_\_\_\_
- (ii) Rest rooms : \_\_\_\_\_

Doc. Title	GENERAL CONDITIONS OF CONTRACT - COMPOSITE WORKS	
Rev. No	0	Page 53 of 104

(iii) Drinking water : \_\_\_\_\_

(iv) Crèches : \_\_\_\_\_

(v) First Aid : \_\_\_\_\_

**Signature of contractor**

Place \_\_\_\_\_

Date \_\_\_\_\_

GENERAL CONDITIONS OF CONTRACT

Doc. Title	GENERAL CONDITIONS OF CONTRACT - COMPOSITE WORKS	
Rev. No	0	Page 54 of 104

**ANNEXURE – H**

**UNDERTAKING FOR COMPETENCE OF WORKMEN**

Name of Associate :

Tender No. :

Item :

With reference to the tender mentioned above, I/We \_\_\_\_\_,  
hereby undertake that the workmen/ employee(s) engaged by M/s  
\_\_\_\_\_ for the job against said tender shall be competent in all  
respect, commensurate to the nature of job.

Date:

\_\_\_\_\_  
( )

Authorized Signatory

For M/s

Seal

Doc. Title	GENERAL CONDITIONS OF CONTRACT - COMPOSITE WORKS	
Rev. No	0	Page 55 of 104

**ANNEXURE-I**

**BUSINESS ASSOCIATE FEEDBACK FORM**

With an objective to improve our internal processes and systems, and serve you better, we solicit your valuable feedback & suggestions. It is estimated that it will take about 10 minutes to complete this survey. We assure you that your feedback shall be kept confidential. Please send the duly filled feedback form in the "TPCODL addressed - attached envelop"

**You are associated with us as**

- OEMs       Service Contractor       Material Suppliers       Material & Manpower Supplier

**You are associated with us for**

- Less than 1 year       More than 1 year but less than 3 years       More than 3 years

**Your office is located at**

- Bhubaneswar       Within 200 kms from Bhubaneswar       More than 200 kms from Bhubaneswar

**Your nearly turnover with TPCODL**

- Less than 25 Lacs       25 Lacs to 1 Crore       More than 1 Cr.

**Additional information**

<b>Your Name</b>	
<b>Your Designation</b>	
<b>Your Organization</b>	
<b>Contact Nos.</b>	
<b>Email</b>	

*We once again thank you for your participation in this survey. Please spare 10 minutes to give your feedback on following pages (Section A to E)*

Doc. Title	GENERAL CONDITIONS OF CONTRACT - COMPOSITE WORKS	
Rev. No	0	Page 56 of 104

### SECTION - A

(Please ✓ mark in the relevant box and give your remarks / suggestions / information for our improvement.).

S. No.	Parameters	1	2	3	4	5	Remarks/ Suggestion
		Do Not Agree	Slightly in Agreement	In Fair Agreement	Mostly in Agreement	Fully Agree	
1	You receive all relevant queries / tenders from us in timely manner.						
2	We provide you enough lead time to respond to our queries / tenders.						
3	We provide you adequate support (drawings, documents, clarifications, briefing etc.) to enable you meet our requirements.						
4	All following elements of our contract / purchase order are rational :						
4.1	Scope of Work						
4.2	Delivery / Execution Schedule						
4.3	Payment Terms						
4.4	Liquidated Damages						
4.5	Performance Guarantee						
5	Our purchase orders / contracts are simple, specific & easy to understand						
6	TPCODL demonstrate willingness to be flexible in administration of Contract / Purchase Order						
7	We provide timely responses / clarifications to your queries						
8	TPCODL representative you interact / coordinate with is adequately empowered to support you in meeting contractual obligations						
9	TPCODL provide you all necessary infrastructure support for timely and quality completion of work (including AMC)						
10	TPCODL Engineer-in-Charge timely certifies the jobs executed/ material supplied						

S. No.	Parameters	1	2	3	4	5	Remarks/ Suggestion
		Do Not Agree	Slightly in Agreement	In Fair Agreement	Mostly in Agreement	Fully Agree	
11	TPCODL Engineer-in-Charge efficiently supervises the job execution for timely completion of job						
12	BIRD (Bill Inward Receipt Desk) initiative has improved payment disbursement process						
13	Our approach for Inspection and Quality Assurance effective to expedite project completion?						
14	TPCODL never defaults on contractual terms						
15	In TPCODL Contracts closure is done within set time limit						
16	Our material receiving procedures are well defined and efficiently deployed to reduce mutual inconvenience						
17	Bank Guarantees are released in time bound manner						
18	Our processes related to payment / account settlement are effective.						
19	You get payments on time						
20	TPCODL Employees follow Ethical behaviour						

Doc. Title	GENERAL CONDITIONS OF CONTRACT - COMPOSITE WORKS	
Rev. No	0	Page 58 of 104

**SECTION - B**

(Please rate the following parameters on a scale of 1 to 5, where 1 - Minimum; 5 - Maximum)

SN	Parameters	1	2	3	4	5	Remarks/ Suggestion
1	How do you rate courtesy/ empathy/ attitude level and warmth of TPCODL employees you interact with from following team?						
1.1	Project Engineering						
1.2	District / Zones						
1.3	Projects/HOG (TS &P)						
1.4	Inspection & Quality Assurance						
1.5	Stores						
1.6	Metering & Billing						
1.7	Accounts / Finance						
1.8	Administration						
1.9	IT & Automation						
2	How would you rate TPCODL in comparison to your other clients in terms of <b>fairness of treatment and transparency</b> with its Business Associates?						
3	How would you rate TPCODL in comparison to your other clients in terms of <b>processes and systems to manage partnership</b> with its Business Associates						
4	How would you rate TPCODL in comparison to your other clients in terms of <b>building long term &amp; mutually relationship</b> with its Business Associates						



**SECTION-C**

Please ✓ mark in the relevant box and give your remarks / suggestions / information for our improvement.

SNo	Parameters	Certainly NO	Probably NO	Probably YES	Certainly YES	Remarks/ Suggestion
1	Based on your experience with TPCODL, would you like to continue your relationship with TPCODL?					
2	If someone asks you about TPCODL, would you talk "positively" about TPCODL?					
3	Would you refer TPCODL name to others in your community, fraternity and society as a professional & dynamic organization?					

**SECTION - D**

**If we ask you to rate us on a scale of 1 to 10, how will you rate TPCODL, that truly represents your overall satisfaction with us (please tick appropriate box) -**

1	2	3	4	5	6	7	8	9	10
---	---	---	---	---	---	---	---	---	----

Doc. Title	GENERAL CONDITIONS OF CONTRACT - COMPOSITE WORKS	
Rev. No	0	Page 60 of 104

### SECTION – E

Please ✓ mark in the relevant box and give your remarks / suggestions / information for our improvement.

Please spare your thoughts for TPCODL's improvement in particular areas of weaknesses, particularly relating to some great practices, attitudes that you have seen elsewhere in Indian and International Organizations, which you recommend TPCODL to adopt. Please give your valuable salient recommendations.

Please spare your thoughts for TPCODL's improvement in particular areas of major concerns for you. We also welcome your suggestions to adopt any best practices, attitudes that you have observed / experienced elsewhere in Indian/ International organization.

Recommendation	<i>Please tick (✓) your top 5 expectations out of the following 10 points listed below -</i>	
(Please list down improvement you expect from TPCODL)	<i>Timely payment</i>	
1	<i>Flexibility in Contracts/PO</i>	
	<i>Clarity in PO,s &amp; Contracts</i>	
2	<i>Timely response to quarries</i>	
	<i>Timely certification of works executed</i>	
3	<i>Clarity in Specs,drawings,other docs etc</i>	
	<i>Adequate information provided on website for tender notification, parties qualified etc.</i>	
4	<i>Timely receipt of material at site for execution</i>	
	<i>Performance Guarantee/EMD released in time</i>	
5	<i>Inspection &amp; quality assurance support for timely job completion</i>	

We thank you for your time and courtesy!!

Doc. Title	GENERAL CONDITIONS OF CONTRACT - COMPOSITE WORKS	
Rev. No	0	Page 61 of 104

## ANNEXURE-J

### ACCEPTANCE FORM FOR PARTICIPATION IN REVERSE AUCTION EVENT

***(To be signed and stamped by the bidder prior to participation in the auction event)***

In a bid to make our entire procurement process more fair and transparent, TPCODL intends to use the reverse auctions through SAP-SRM tool as an integral part of the entire tendering process. All the bidders who are found as technically qualified based on the tender requirements shall be eligible to participate in the reverse auction event.

**The following terms and conditions are deemed as accepted by the bidder on participation in the bid event:**

1. TPCODL shall provide the user id and password to the authorized representative of the bidder. *(Authorization Letter in lieu of the same shall be submitted along with the signed and stamped Acceptance Form).*
2. TPCODL will make every effort to make the bid process transparent. However, the award decision by TPCODL would be final and binding on the supplier.
3. The bidder agrees to non-disclosure of trade information regarding the purchase, identity of TPCODL, bid process, bid technology, bid documentation and bid details.
4. The bidder is advised to understand the auto bid process to safeguard themselves against any possibility of non-participation in the auction event.
5. In case of bidding through Internet medium, bidders are further advised to ensure availability of the entire infrastructure as required at their end to participate in the auction event. Inability to bid due to telephone line glitch, internet response issues, software or hardware hangs, power failure or any other reason shall not be the responsibility of TPCODL.
6. In case of intranet medium, TPCODL shall provide the infrastructure to bidders. Further, TPCODL has sole discretion to extend or restart the auction event in case of any glitches in infrastructure observed which has restricted the bidders to submit the bids to ensure fair & transparent competitive bidding. In case an auction event is restarted, the best bid as already available in the system shall become the start price for the new auction.
7. In case the bidder fails to participate in the auction event due any reason whatsoever, it shall be presumed that the bidder has no further discounts to offer and the initial bid as submitted by the bidder as a part of the tender shall be considered as the bidder's final no regret offer. Any offline price bids received from a bidder in lieu of non-participation in the auction event shall be outrightly rejected by TPCODL.
8. The bidder shall be prepared with competitive price quotes on the day of the bidding event.
9. The prices as quoted by the bidder during the auction event shall be inclusive of all the applicable taxes, duties and levies and shall be FOR at TPCODL site.
10. The prices submitted by a bidder during the auction event shall be binding on the bidder.
11. No requests for time extension of the auction event shall be considered by TPCODL.
12. The original price bids of the bidders shall be reduced on pro-rata basis against each line item based on the final all inclusive prices offered during conclusion of the auction event for arriving at Contract amount.

**Signature & Seal of the Bidder**

Doc. Title	<b>GENERAL CONDITIONS OF CONTRACT - COMPOSITE WORKS</b>	
Rev. No	0	Page 62 of 104

**ANNEXURE-K**

To,

DGM (Finance)

The TP Central Odisha Distribution Limited  
Bhubaneswar

Sub: **e-Payments through National Electronic Fund Transfer (NEFT) OR Real Time Gross Settlement System (RTGS)**

Dear Sir,

We request and authorize you to affect e-payment through NEFT/RTGS to our Bank Account as per the details given below:-

Vendor Code :

Title of Account in the Bank :

Account Type :

(Please mention here whether account is Savings/Current/Cash Credit)

Bank Account Number :

--	--	--	--	--	--	--	--	--	--	--	--	--	--	--	--	--	--	--	--

Name & Address of Bank :

Bank Contact Person's Names :

Bank Tele Numbers with STD Code :

Bank Branch MICR Code :

--	--	--	--	--	--	--	--	--	--	--	--	--	--	--	--	--	--	--	--

(Please enclose a Xerox a copy of a cheque. This cheque should not be a payable at par cheque)

Bank Branch IFSC Code :

--	--	--	--	--	--	--	--	--	--	--	--	--	--	--	--	--	--	--	--

(You can obtain this from branch where you have your account)

Email Address of accounts person (to

Doc. Title	GENERAL CONDITIONS OF CONTRACT - COMPOSITE WORKS	
Rev. No	0	Page 63 of 104

send payment information)

Name of the Authorized Signatory :

Contact Person's Name :

Official Correspondence Address :

We confirm that we will bear the charges, if any, levied by our bank for the credit of NEFT/RTGS amounts in our account. Any change in above furnished information shall be informed to TPCODL well in time at our own. Further, we kept TPCODL indemnified for any loss incurred due to wrong furnishing of above information.

Thanking you,

For \_\_\_\_\_

**(Authorized Signatory)**

**(Signature with Rubber Stamp)**

**Certification from Bank:**

We confirm that we are enabled for receiving NEFT/RTGS credits and we further confirm that the account number (specify Bank a/c no.) of (Please mention here name of the account holder), the signature of the authorized signatory and the MICR and IFSC Code of our branch mentioned above are correct.

This also is certified that the above information is correct as per Bank record

**(Manager's/ Officers Signature under Bank Stamp)**

Doc. Title	GENERAL CONDITIONS OF CONTRACT - COMPOSITE WORKS	
Rev. No	0	Page 64 of 104

**ANNEXURE-L**  
**CONTRACTOR SAFETY MANAGEMENT SYSTEM**

**1. OBJECTIVE**

The objective of the Contractor Safety Management System is to lay down clear guidelines for all Business Associates (including their associates, staff and agents) which would facilitate them to observe all statutory rules and regulations, comply with applicable standards of Central Electricity Authority (Measures relating to safety and electric supply) Regulations, 2010 & (safety requirements for construction, operation and maintenance of electrical plants and electric lines) Regulations, 2011, TPCODL Safety Manual and Guidelines and thus, ensure creation of safe working environment for all stakeholders of our network.

**2. SCOPE**

All contracts (minor and major) will be subject to the provisions of this document.

**Minor Contracts:** Contracts which satisfy all the criteria listed under the head “Minor Contracts”.

**Major Contracts:** Contracts which satisfy any two or more criteria listed under the head “Major Contracts”

Criteria	Minor Contracts	Major Contracts
Value of Contract	< Rs. 1500000/- (less than Rs. Fifteen Lac)	>= Rs. 1500000/- (Equal or more than Rs. Fifteen Lac)
Period	Period less than 1 year	Any period
Working on energized electrical equipment	No	Yes
Working on height (above 1.8 Mtrs from ground)	No	Yes
Work involving construction activity	No	Yes
Working with hazardous goods or chemicals	No	Yes
Work involving danger to general public	No	Yes

**Note:** Exceptions for major and minor contract are – in house software development, supply of material or equipment but no direct or indirect installation of the same material, administration contracts (courier, water supply, printing, security, transport, etc.), minor civil work like plastering at ground level or flooring, etc. The facility management (housekeeping) contract will always be treated as a minor contract.

Doc. Title	GENERAL CONDITIONS OF CONTRACT - COMPOSITE WORKS	
Rev. No	0	Page 65 of 104

### 3. INFORMATION REQUIRED AT TIME OF VENDOR REGISTRATION OR BEFORE COMMENCEMENT OF CONTRACT

- 3.1 Business Associate is required to fill the Safety Management System Questionnaire as per *annexure 1* and submit along with the vendor registration process / bid / tender document. The filled questionnaire will be scrutinized by Engineer In-charge / indenting group and recommend suitability of the BA with respect to safety requirements. The fulfilment of statutory requirements for vendor registration pertaining to labour laws etc. shall be done by BA Cell on being referred to it.
- 3.2 Business Associate is required to take suitable risk control measures mentioned against the identified Hazards and Risk document provided for all contracts as per *annexure 2*. The primary objective of this is to evaluate the understanding of the BA towards risk mitigation and employment of safe work procedures. BA is required to conduct the Hazard identification and Risk Assessment study as per the procedure and deploy more or other measures if deemed necessary.
- 3.3 Business Associate shall comply with **Statutory Requirements related to Safety and Occupational Health** and submit the "Safety Undertaking" as per *annexure 4*.

### 4. GENERAL SAFETY CONDITIONS REQUIRED TO BE FULFILLED BY BUSINESS ASSOCIATES

The requirements of the contractor safety management system applicable to the minor or major contracts related to various groups are as following –

- 4.1 Maintenance of Distribution Network – *Annexure 3.1*
- 4.2 Distribution Projects – *Annexure 3.2*
- 4.3 EHV Projects – *Annexure 3.3*
- 4.4 Maintenance of Sub transmission network – *Annexure 3.4*
- 4.5 Civil / Generation Projects – *Annexure 3.5*
- 4.6 Meter Management Group (MMG), Revenue Recovery Group (RRG), Energy Auditing Group, AMI, MRG, etc. – *Annex3.6*
- 4.7 Maintenance and Operation of Street Light. – *Annexure 3.7*

1. *Please note that hydra cranes used by any dept should be ACE Model No. FX 150 ACE SX 150, Escorts Model No. TRX 1550 or contemporary. Use of old generation hydra cranes like ACE 14XW or ACE 12 XW, etc are prohibited.*

**(Details as per Annexure attached)**

**Note:** For minor contracts, the BA shall assign the duties of Safety Representative to the Work Supervisor. Work Supervisor will deliver all duties and responsibilities of Safety Supervisor as detailed in this document.

The Business Associate (BA) having major contract will appointing Safety supervisor, engineer / manager for the TPCODL work. The BA shall make all necessary arrangements for getting their workforce safety trained and competency checked from the concerned official of TPCODL before deployment in the field. BA Cell shall recommend the suitability after competency checked by Engineer In-charge and SAFETY group (or his representative) of TPCODL. After getting the clearance from concerned official, BA cell and receiving temporary I-card issued by TPCODL, Business Associate shall commence the working.

Safety Representative of Business Associates will formally become the nodal point for safety concerns for TPCODL. **BA shall not frequently transfer or terminate the services of any of the safety representatives appointed for TPCODL work site. BA needs to ensure**

Doc. Title	GENERAL CONDITIONS OF CONTRACT - COMPOSITE WORKS	
Rev. No	0	Page 66 of 104

**that Safety representative is available at all points of time; failing which the work being carried out in the interim (period when Safety representative is not available) shall be treated as working under improper supervision and due penal provisions shall be initiated against the BA.** BA will be required to provide all applicable infrastructure and power to ensure smooth working of the safety representative to maintain a sound safety management system. **In all contracts safety representative will not be assigned any other activity at site apart from the works related to safety management. The duties are detailed in clause 5.5 of this document.** TPCODL will be auditing the facilities provided to the BA's safety team time to time.

The Safety Representative of the BA shall be required to meet and follow the instructions of the Engineer In-charge and SAFETY Group of TPCODL. He shall be responsible for providing the MIS and/or any other relevant information, as and when desired, within the stipulated time frame as per the requirements of TPCODL. Any non-conformance to safety will lead to the negative marking or issue of safety violation challan/ tokens which shall affect the monthly evaluation and performance of BA.

All contracts where BA has to depute vehicle for their staff and equipment to move from one location to other, the BA shall ensure that vehicle complies all required statutory clearances and requirement as per The Motor Vehicle Act, 1988 as well as TPCODL Road Safety Policy and are in good & safe state of working.

## **5. QUALIFICATION AND EXPERIENCE OF THE SAFETY AND SITE PERSONNEL**

Qualification and experience required for the safety and site personnel are as following:

**5.1 Safety Supervisor:** It is mandatory that educational qualification of safety supervisor be ITI (of relevant trade) / Diploma (Any branch of engineering) and he has a working experience on electrical system / relevant field of work at least 5 yrs for ITI and 3 years for Diploma holder. Having formal experience of the safety systems will be an added advantage

**5.2 Safety Engineer:** It is mandatory that educational qualification of safety engineer be at least Diploma (relevant branch) and he has working experience on electrical system of at least 3 yrs. Having the formal experience of the safety systems will be an added advantage.

**5.3 Safety Manager:** The educational qualification of safety manager should be graduate engineer with working experience on electrical system / network of at least 3 yrs. OR Diploma in Industrial Safety with working experience of 05 years including at least 02 years on electrical network.

However, clause 5.1, 5.2 and 5.3 are not applicable for minor contracts. In such cases, BA shall assign the duties of Safety Representative to the Work Supervisor. Work Supervisor will deliver required duties of Safety Representative (as per clause 5.5) in addition to other duties without diluting the importance of safety.

**5.4 Site Skilled Personnel:** For all responsibility related to site activities and operations, the BA shall employ only qualified and skilled persons and shall comply the provisions of section 19 & 29 of Central Electricity Authority (Measures relating to safety and electric supply) Regulations, 2010. Persons holding valid approvals only by any Government approved agency or a competency assessment panel or a team set up by TPCODL



Doc. Title	GENERAL CONDITIONS OF CONTRACT - COMPOSITE WORKS	
Rev. No	0	Page 67 of 104

shall be allowed to perform the High Risk / High Hazard activities (refer page 1). The skill / qualification required for the electrician and electrical supervisor are given in *annexure 5*. The contracts related to maintenance of Distribution Network, Distribution Projects, EHV Projects, maintenance of Sub-Transmission Network, MMG & EAG, maintenance and operation of street lights, shall preferably have at least 20 per cent of ITI qualified electricians in the first year of the contract. This figure shall preferably be incremented by 15 per cent every subsequent year.

*Note: For the competency assessment may please refer the work instructions. An employee shall have to necessarily undergo the competency assessment check once in every eighteen months.*

#### **5.5 Requirements from the Safety Representative(s) of the Business Associate:**

- 5.5.1 Safety training of 2 hrs/employee/month and one day of safety induction training to all new employees joining the BA will be conducted by the BA as per Safety training modules of TPCODL.
- 5.5.2 Safety Talk / tool box talk before start of shift to BA employees.
- 5.5.3 Ensuring the availability & proper usage of the standard safety equipment (PPE)
- 5.5.4 Periodic inspection of PPE to ensure their serviceability and maintaining the 10% buffer stock of standard PPEs.
- 5.5.5 Ensuring the adherence to standard operating procedures of TPCODL as mentioned in TPCODL Safety standard and O & M and concerned function's manual.
- 5.5.6 Safety inspections / audits as per the process of TPCODL
- 5.5.7 Working in close coordination SAFETY Group of TPCODL.
- 5.5.8 Reporting of unsafe acts, unsafe conditions, near miss, incident or accident to Engineer In-Charge and SAFETY Group of TPCODL immediately after its occurrence.
- 5.5.9 Regular HIRA at site and comply the control measures as stated in the detailed HIRA as per the *annexure 2*. Also deployment of JSA based checklist shall be ensured.
- 5.5.10 Ensuring compliance with safety and other laws as may be applicable and providing for safety assurance.

#### **5.6 Training and Syllabus:** The BA shall not deploy any person at work place / site or send newly recruited personnel directly to concerned official for competency assessment without Safety Induction Training.

5.6.1 All new BA employees have to necessarily undergo one and half days Safety training and Competency assessment at training centre of BA cell. This training will be conducted once in a week. After the completion of Safety training & Competency assessment I-card will be issued to all competent BA employees

5.6.2 BA is expected to initially train and judge the capability of the workman at his own end before further recommending the workmen for Competency assessment. If any BA workman sent for competency assessment. In case any BA workman fails in the Competency test at concerned official, it will be deemed that BA has not imparted sufficient training at his end and actual cost of training ₹ 7500/ BA employee/ failed attempt will be recovered.

5.6.3 The workers who have imparted Safety Training and issued I-Cards of TPCODL, are not deployed at TPCODL worksites/ voluntarily left the job by workers/ used somewhere else other than TPCODL by the BA, in that case Management reserves the rights to intervene and recover the actual cost of training i.e. ₹ 7500/BA employee. (*Exempted for attrition rate of BA workers less than or equal to 10% of total workforce deployed at TPCODL*)

Doc. Title	GENERAL CONDITIONS OF CONTRACT - COMPOSITE WORKS	
Rev. No	0	Page 68 of 104

5.7 It is desired that Safety representative of the BA to impart the general safety training to each employee of duration 2 hrs per month. The training will be organized at BA level and the record to be sent to engineer in-charge and SAFETY group of TPCODL every month. Please refer schedule and syllabus in *annexure 6*.

**List of Personal Protective Equipment (PPE) and Maintenance schedule:** BA shall commence the project or any work only when the required PPE are made available to the team of employees involved in the work. Each PPE of BA shall be checked / inspected by the safety representative / supervisor at zone before the work start or as prescribed in the list. Safety representative shall regularly check the healthiness of each PPE allocated to lineman. Suitable record shall be maintained at zone. Defective PPE shall be immediately replaced or within 24 hours by the BA. In no case linemen or any other official of BA may be allowed to work with defective PPE. It is preferred that BA ensures minimum stock of each PPE at zone for immediate replacement with defective one. The PPE shall be IS / BS / CE marked and exactly as per the standard or specification mentioned in the *annexure 7*. Working without PPE / non-standard PPE shall be treated as safety violation and penalty as stated in section 6.0 of this document. If TPCODL finds that BA has not provided the adequate / appropriate PPE to their staff, TPCODL reserves the rights to stop the work and call the BA to provide appropriate PPEs at the risk. If the BA fails to provide the required PPEs at the risk then the same shall be provided by TPCODL at the actual cost of the PPE. The amount shall be charged to BA and same shall be first recovered from the current bill of BA or any future payment to be made to BA. In the event of any balance amount still left for recovery, the same shall be adjusted against retention amount or by invoking bank guarantee submitted by BA.

**5.8 Safety Audit / Inspection & HIRA:** The BA shall get the required safety inspection / audit conducted by his technical team comprising of safety representative as per the *annexure 8*. The safety representative will be required to conduct the HIRA (Hazard Identification and Risk Assessment) *as per annexure 2* of the process and work undertaken at least two times in a year or every time if a new process / activity / machine is introduced or whenever an accident take place. The risk identified to be addressed suitably with –

- Engineering Control
- Management Control, and
- Personal Protective Equipment.

The safety representative of BA shall inform and educate for the identified risk and hazard control methods to employees, supervisor and engineer as well as the engineer in-charge and SAFETY group of TPCODL.

**5.9 Safety Performance and Safety MIS:** The BA shall maintain good practice of safety all through the contract duration. Safety shall always be of paramount importance during the contract period. Safety performance will be monitored on yearly basis throughout the period and no relaxation will be given for bad performance. BA with good track record and excellent performance will be rewarded suitably as per clause 6.0 of this document. The BA has to provide monthly “Performance Report – Safety” to engineer in-charge and SAFETY group TPCODL this shall be part of monthly bill along with training details. Performa of the report is enclosed as *annexure 9*.

**5.10 Pre – Employment Medical Check-up and Fitness of employees engaged for the critical works:** The BA shall submit the health fitness certificate for all those workers involved in climbing the pole or working at height for following diseases:

5.10.2 Epilepsy

Doc. Title	GENERAL CONDITIONS OF CONTRACT - COMPOSITE WORKS	
Rev. No	0	Page 69 of 104

- 5.10.3 Colour blindness
- 5.10.4 Deafness
- 5.10.5 Vertigo & height phobia

Every year BA will give an undertaking stating that all the employees are fit to work and have not developed aforesaid diseases. The Record of such medical check-ups shall be submitted to BA Cell before issue of temporary identity card. The records shall be maintained at BA Cell. All such medical check-ups shall be repeated once in a year for all workers involved in climbing the pole or working on electrical network.

## 6. REWARD AND PUNITIVE MEASURES

**6.1** To support the enforcement of good SHE & DM practices by the Business Associate and to eliminate repeated or continuing safety violations, use of appropriate reward and punitive measures shall be made. Each unsafe act or violation of the safety guidelines as described in the Safety Manual of the TPCODL will be audit criteria of this system. Broadly the measures identified are following:

- 6.1.1 Working without PPE/ Safety Gadgets
- 6.1.2 Working without proper tools and tackles, barricading, Poor condition of Crane / Hydra / Vehicle, using without certification / Licence, Incompetent driver/ Helper
- 6.1.3 Working without creation of effective safety zone
- 6.1.4 Improper Supervision at worksite, Lineman/ Supervisor working without competency
- 6.1.5 Working without adherence to PTW process or authorization/ not adherence to SOPs / W.I. of TPCODL.
- 6.1.6 Improper Working at height equal to or above 1.8 mtrs without taking proper fall protection measures/ Poor condition of Ladder

### 6.2 Measures of Reward and Punitive Measures

The Engineer In-Charge, NSO, SC, ASOs, CSI / SIs and SHE &DM group will conduct the surprise audits of the work / project and if any non-conformance is found the same will be booked and entered in the format "Safety Violation Record" *annexure 10*. The flow of the information is given below:

Safety Violation Escalation & Monitoring process	
Action	Responsibility
Safety Violation form has been filled and counter foil sent to SAFETY team for information. The main form is to be given to BA supervisor / Engineer in-charge. <i>(Automatically generated if Site audit done through Mobile App.)</i>	Engineer In-charge/ NSO / SC / SAFETY Group /CSI/ ASO/ Any authorised TPCODL official.
↓	
Entry of the violation in the master record and sending the information to concerned Manager, HoG, HoD, Head and Chief (O &S). <i>(Automatically generated if Site audit done through Mobile App.)</i>	SAFETY Group
↓	
Forwarding the information Centralized Account Payable (CAPS) for amount deduction from the current bill of the BA,	Engineer In-charge

<i>if any.</i>	
↓	
HoG (Safety – II) & HoG (Safety & Quality – Commercial) and CAPS to generate the MIS of the violations and the amount deducted.	SAFETY Group
↓	
The pool of the amount generated after the deduction to be utilized in safety welfare of BA employees.	SAFETY Group with approval of CFO/Chief (O & S) /CEO&MD

The safety violations have been rated from 1 to 5 (figure 6.3) as per the gravity of the violation. If the same violation is repeated it may escalate into a higher penalty. If a particular Business Associate employee violates safety norms three times, he shall not be allowed to work in TPCODL for a period of one year from the date of the 3<sup>rd</sup> violation.

### 6.3 Safety Violation Escalation Matrix

#### 6.3.1

Consequence of Safety Violation Observed (Not related to Incident/ Accident)		Violation				Subsequent Violations
S.No.	Safety Violation	1st	2nd	3rd	4th	
1	Working without PPE (Helmet/Gloves/Safety Harness/ Safety Shoes etc.)	A	B	C	D	Will attract the same penalty as applicable in the 4th violation.
2	Improper Working at Height	A	B	C	D	
3	Working without proper tools and tackles	A	B	C	D	
4	Poor condition of Crane/Hydra/ Vehicle/Incompetent driver/ Helper	A	B	C	D	
5	Violation of SOP/ WI	B	C	D	E	
6	Working without adherence to PTW process or authorization/ Safety Zone	C	D	E		
<b>Legend</b>		<b>Action to be taken</b>	<b>Responsibility</b>	<b>Penalty Amount (in Rs.)</b>		The number of violations are to be calculated cumulatively over the contract period and not on monthly basis.
A	Warning letter	Engineer Incharge	Nil			
B	Levy of Penalty	Engineer Incharge	2,000			
C	Memo to BA & Levy of Penalty	Head of Group	4,000			
D	Memo to BA & Levy of Penalty	Head of Department	10,000			
E	Memo to BA, Levy of Penalty and termination of Contract	Head of Department	1,00,000			

Figure 6.3 (1a)-Penalty Matrix for Safety violation (Applicable for Minor Contracts)

Consequence of Safety Violation Observed (Not related to Incident/ Accident)		Violation				Subsequent Violations
S.No.	Safety Violation	1st	2nd	3rd	4th	
1	Working without PPE (Helmet/Gloves/Safety Harness/ Safety Shoes etc.)	B	C	D	D	Will attract the same penalty as applicable in the 4th violation.
2	Improper Working at Height	B	C	D	D	
3	Working without proper tools and tackles	A	B	C	D	
4	Poor condition of Crane/Hydra/ Vehicle/Incompetent driver/ Helper	B	C	D	E	
5	Violation of SOP/ WI	C	D	E		
6	Working without adherence to PTW process or authorization/ Safety Zone	C	D	E		
<b>Legend</b>		<b>Action to be taken</b>	<b>Responsibility</b>	<b>Penalty Amount (in Rs.)</b>		The number of violations are to be calculated cumulatively over the contract period and not on monthly basis.
A	Levy of Penalty	Engineer Incharge	5,000			
B	Memo to BA & Levy of Penalty	Engineer Incharge	10,000			
C	Memo to BA & Levy of Penalty	Head of Group	25,000			
D	Memo to BA & Levy of Penalty	Head of Department	50,000			
E	Memo to BA, Levy of Penalty and termination of Contract	Head of Department	1,00,000			

Figure 6.3 (1b)-Penalty Matrix for Safety violation (Applicable for Major Contracts)

Doc. Title	GENERAL CONDITIONS OF CONTRACT - COMPOSITE WORKS	
Rev. No	0	Page 71 of 104

Once the BA reaches the “BLACK” (color – “5”) category, i.e. highest level of safety violation, “Termination” notice to BA will be issued from the office of the Head of Department (equivalent to Addl GM/ GM/ Sr. GM level) and further, *if required*, continuation / extension of contract will only be initiated by Functional Head of the department (equivalent to Sr. GM / VP level) and approved by CEO & MD. Till the extension, the contract will remain suspended.

TPCODL encourages the reportage of the safety violation during the contract work by BA. Any TPCODL employee can register a safety violation against the BA in the “Safety Violation Form” *annexure 10*. Initially the observer has to fill the form and handover the counterfoil (lower portion) of the document to the supervisor of the BA, inform the site engineer of TPCODL and send the top portion of the Safety Violation Form to SAFETY group for the further necessary action against the BA. **The cumulative nos. of Safety Violations pertaining to any particular BA shall be calculated on yearly basis.**

Safety violations resulting in incident / accident will be treated as per gravity of the injury / fatality and its impact as well as type i.e. minor or Major. Consequences of incident / accident are shown in the matrix (figure 6.3(2) for major and 6.3(3) for minor) below. In case of any accident, findings and recommendations of Accident Enquiry Committee will be final and binding and will supersede the arbitration clause of GCC.

Consequence Of an Incident / Accident (In case of <b>MAJOR</b> contract)		Incident / Accident				Action Required
Sl. No	Type of the injury	1st	2nd	3rd	4th	
1	Slight injury (First Aid Case)	<b>F</b> (Strengthening of process through continuous improvement in the work procedure)				Take risk reduction measures
2	Minor injury (No or Hospitalization less than 48 Hrs)	<b>F</b>	<b>G</b>	<b>G</b>	<b>H</b>	
3	Major injury (Bone injury or burn or Hospitalization more than 48 Hrs)	<b>G</b>	<b>G</b>	<b>H</b>	<b>I</b>	
4	Single fatality	<b>J</b>	<b>K</b>			Intolerable
5	Multiple fatalities (Two or more fatalities during one event)	<b>K</b>				
Legend	Action to be taken	Responsibility	Penalty (in Rs.)	The number of violations are to be calculated cumulatively over the contract period and not on monthly basis.		
<b>F</b>	Memo to BA and levy of penalty	Engineer Incharge	5,000/-			
<b>G</b>	Memo to BA and levy of penalty	Head of Group	20,000/-			
<b>H</b>	Memo to BA and levy of penalty	Head of Group	50,000/-			
<b>I</b>	Memo to BA and levy of penalty	Head of Department	2,00,000/-			
<b>J</b>	Memo to BA and levy of penalty	Head of Department	5,00,000/-			
<b>K</b>	Memo to BA, levy of penalty, termination of contract and black listing of BA	Functional Head	10,00,000/-			

Figure 6.3 (2) - Penalty Matrix for Incident / Accident in Major Contracts

(For example: In major contracts, if there is first incidence of major injury say bone injury (Cat. 3) where worker was hospitalized for more than 48 hrs then a penalty of amount Rs.20000/- will be deducted from the current bill produced for the payment. This penalty will be similar for first two incidents. However, it will increment to next higher category i.e. Rs. 50,000/- on subsequent incidents as per the above matrix)

Doc. Title	GENERAL CONDITIONS OF CONTRACT - COMPOSITE WORKS	
Rev. No	0	Page 72 of 104

Consequence Of an Incident / Accident (In case of <b>MINOR</b> contract)		Incident / Accident				Action Required
Sl. No	Type of the injury	1st	2nd	3rd	4th	
1	Slight injury (First Aid Case)	<b>L</b> <small>(Strengthening of process through continuous improvement in the work procedure)</small>				Take risk reduction measures
2	Minor injury (No or Hospitalization less than 48 Hrs)	<b>L</b>	<b>M</b>	<b>M</b>	<b>N</b>	
3	Major injury (Bone injury or burn or Hospitalization more than 48 Hrs)	<b>M</b>	<b>M</b>	<b>N</b>	<b>O</b>	
4	Single fatality	<b>P</b>	<b>Q</b>			Intolerable
5	Multiple fatalities (Two or more fatalities during one event)	<b>Q</b>				
Legend	Action to be taken	Responsibility	Penalty (in Rs.)	<i>The number of violations are to be calculated cumulatively over the contract period and not on monthly basis.</i>		
<b>L</b>	Memo to BA and levy of penalty	Engineer Incharge	5,000/-			
<b>M</b>	Memo to BA and levy of penalty	Engineer Incharge	10,000/-			
<b>N</b>	Memo to BA and levy of penalty	Head of Group	25,000/-			
<b>O</b>	Memo to BA and levy of penalty	Head of Department	1,00,000/-			
<b>P</b>	Memo to BA and levy of penalty	Head of Department	3,00,000/-			
<b>Q</b>	Memo to BA, levy of penalty, termination of contract and black listing of the BA	Functional Head	5,00,000/-			
<b>Figure 6.3 (3) - Penalty Matrix for Incident / Accident in Minor Contracts</b>						

(For example: In minor contracts, if a worker meets with a non-fatal accident say bone injury (Cat. 3) where he was hospitalized for more than 48 hrs then a penalty of amount Rs. 10,000/-, will be charged from the current bill produced for the payment. This penalty will be similar for first two incidents. However, it will increment to next higher category i.e. Rs. 25,000/- on subsequent incidents as per the above matrix.)

In case of single or multiple fatalities described under legends J&K of 6.3(2) and P&Q of 6.3(3), the concerned BA may be debarred from extension of contract or participate in new contract. In such event the approval of Chief (O & S) will be necessary for extension or award of new contract to concerned BA.

### 6.3.2 COMPENSATION FOR BA PERSONNEL

In the event of any untoward incident/ accident, the Business Associate shall ensure prompt medical assistance such as treatment, sickness benefit, etc. is provided to the victim(s) as per the Employees' Compensation Act, 1923 or Employees' State Insurance Act, 1948, as applicable. Also, the BA will be required to take adequate measures for compensating the victim(s) or his/her/their kin as follows:

#### I. For Death or Permanent / Total Disablement

The BA shall take an insurance coverage of at least Rs. 10 lakhs for each engaged employee, to cover any incidence of Death or Permanent / Total Disablement (Permanent/Total Disability shall be considered as defined under Employees' Compensation Act, 1923). In the event of any such unfortunate incident, the BA would ensure that adequate compensation is paid immediately to the family of the victim(s) from his own resources. This compensation shall be covered under the insurance policy subscribed by the BA mentioned earlier and the arrangement should be such that it would get reimbursed to the BA by the insurance agency subsequently.

Doc. Title	GENERAL CONDITIONS OF CONTRACT - COMPOSITE WORKS	
Rev. No	0	Page 73 of 104

## II. For Permanent Partial Disablement and Temporary Total Disablement

The compensation in this case will be as per provisions of the Employees' Compensation Act, 1923 or Employees' State Insurance Act, 1948, as applicable.

Accordingly, the BA shall obtain a suitable Insurance Policy on award of Contract and submit documentary evidence of the policy to the BA Cell before commencement of work. The BA shall ensure that the Insurance policy is active at all times and all employees are covered in all respects till the conclusion of contract period or till working with TPCODL. The BA shall submit a copy of the policy after periodic renewals to the BA Cell.

However, on occurrence of such unfortunate incident, if it is found that the victim(s) is/are not covered under any insurance policy, the BA shall be liable to pay the entire sum of Rs. 10 lakhs from his own resources.

Further, in case of an accident resulting in Death or Permanent / Total Disablement while on duty, the appointed BA Nodal Officer will ensure that the BA complies with all statutory provisions and benefits i.e. PF, Compensation, Gratuity etc., and that all these are made available to the employees' nominee(s) as per the stipulated timelines.

**6.3.3** TPCODL rewards the BA with good track record of safety management. It is proposed that BA complying with Contractors Safety Management, Safety Manual and Safety process will be rewarded suitably as per the procedure, rule and regulations of the TPCODL. In any case major accident is reported during an assessment period BA will not be eligible for this reward scheme. Assessment of contracts will be once in year. Generally the assessment cycle is calendar year and guidelines will be declared time to time.

### Abbreviations Used in the Document

TPCODL	TP Central Odisha Distribution Limited
BA	Business Associate
HIRA	Hazard Identification & Risk Assessment
JSA	Job Safety Analysis
EHV	Extra High Voltage
SAFETY	Safety, Occupation Health, Environment & Disaster Management
MMG	Meter Management Group
EAG	Energy Audit Group
PPE	Personal Protective Equipment
SOP	Standard Operating Procedures
CSI/SI	Circle Safety In-charge / Safety In-charge
ASO	Area Safety Officer
NSO	Nodal Safety Officer
SC	Safety Coordinator
HoG / HoD	Head of Group / Head of Department
AGM / GM / VP	Assistant General Manager / General Manager / Vice President

Doc. Title	<b>GENERAL CONDITIONS OF CONTRACT - COMPOSITE WORKS</b>	
Rev. No	0	Page 74 of 104

CFO / Chief (O & S)/ CEO & MD	Chief Finance Officer / Chief (Operating & Safety) / Chief Executive Officer & Managing Director
COS	Corporate Operation Services
CAP	Centralized Account Payable System
PTW	Permit To Work
GCC	General Conditions of Contract.

- END -

GENERAL CONDITIONS OF CONTRACT



Doc. Title	GENERAL CONDITIONS OF CONTRACT - COMPOSITE WORKS	
Rev. No	0	Page 75 of 104

**Annexure 1 (Refer Para 3.1)**

***Business Associate Safety Management System Questionnaire***

Certification					
The information provided in this questionnaire is a summary of the company's occupational health and safety management system.					
Company Name:					
Turnover and experience:		Name of top officer:			
Date:		Position			
Contract Details					
Contract Name			Contract Number:		
Business Associates Safety Management System Questionnaire		Marks	Yes	No	Score achieved
<i>Safety Policy and Management</i>					
<b>- Is there a written company Safety policy?</b> - If yes provide a copy of the policy, if No please refer Note 1.		1			
<b>- Does the company have an Safety Management system</b> - If yes provide details, if No please refer Note 1.		1			
<b>- Is there a company Safety Management System manual or plan?</b> - If yes provide a copy of the content page(s), if No please refer Note 1.		2			
<b>- Are Safety and occupational health responsibilities clearly identified for all levels of Management and staff?</b> - If yes provide details, if No please refer Note 1.		2			
<i>Safe Work Practices and Procedures</i>					
<b>- Has the company prepared safe operating procedures or specific safety instructions relevant to its operations and relevant work as per contract?</b> - If yes provide a summary listing of procedures or instructions, if No please refer Note 2.		1			

Certification				
- Comments				
- <b>Is there a register of injury or accident?</b> - If yes provide a copy (format)	1			
- <b>Is there a documented incident or accident investigation procedure?</b>  - If yes provide a copy of a standard incident report form, if No please refer Note 2.  - Comments	1			
<i>Safety Training</i>				
- <b>Describe how occupational health and safety training is conducted in your company</b>  If No please refer Note 1.	2			
- <b>Is a record maintained of all training and induction programs undertaken for employees in your company?</b>  - If yes provide examples of safety training records, if No please refer Note 2.	1			
- <b>Are regular safety inspections / audits are undertaken at worksites?</b>  -If yes provide details (formats), if No please refer Note 3.	1			
- <b>Is there a procedure by which employees can report hazards at workplaces?</b>  - If yes provide details if No please refer Note 1.	1			
<i>Safety Monitoring</i>				
- <b>Is there an officer / supervisor responsible for monitoring workplace / worksite safety?</b>	1			

Certification				
- If yes provide details				
<i>Safety Performance Monitoring</i>				
- <b>Are employees regularly provided with information on company health and safety performance?</b>	1			
- If yes provide details				
- <b>Has the company ever been convicted of an occupational health and safety offence?</b>	NO Marks (Negative mark ONE for each case)			
- If yes provide details				
- Has there been any major accident of employee at TPCODL site in past	NO Marks (Negative mark ONE for each case)			
- Has there been any fatal accident of employee at TPCODL site in past. - (Note: Bid evaluation committee has to take cognizance of the incident and shall evaluate the bid only after formal approval of competent authority i.e. CTO. - In case of yes please refer Note 4.	NO Mark (Negative mark FIVE for each case)			
Minimum of 75% marks is required for qualification.		Total Marks achieved		
<i>Company Reference</i>				
1. Name of company 2. Name of company				

**Note**

1: If company does not have formal procedure on Safety Management System than vendor may submit proposed Safety road map along with safety action plan and brief safety policy on his letter head signed by head of the organization.

2: The vendor may submit the same in the Safety Action Plan.

3: The vendor may utilize the same format of TPCODL or on request SAFETY group will assist the vendor in developing the audit system. For other points also vendor may take the assistance of SAFETY group for development of Safety management system.

Doc. Title	GENERAL CONDITIONS OF CONTRACT - COMPOSITE WORKS	
Rev. No	0	Page 78 of 104

*4: The vendor may submit the Safety Improvement Plan and Safety Action Plan for his employees based on following points.*

- i. Action plan for enhancing safety awareness*
- ii. Action plan for safety training of employee*
- iii. Action plan for increasing safety audit in field*
- iv. Action plan for provision and utilization of safety PPE.*
- v. Action plan for fatality reduction.*
- vi. Action plan for enhanced supervision at site*
- vii. Action plan for making employee more responsible and accountable for safety.*
- viii. Action plan for availability and utilization of all required tool and equipment.*
- ix. Safety Improvement done in last two years, specially highlighting those which have been taken after the fatal accident along with results.*
- x. Safety initiatives planed or started recently.*
- xi. Any other point.*

*Based on above points and documentary evidences vendor will be required to submit a detailed report in support of his bid. The bid evaluation committee and competent authority will scrutinize the facts and the evidence submitted. If found satisfactory competent authority i.e. CTO may accord his approval for bid opening otherwise his tender shall be disqualified.*

Doc. Title	GENERAL CONDITIONS OF CONTRACT - COMPOSITE WORKS	
Rev. No	0	Page 79 of 104

**Annexure 2 (Refer Para 3.2 and 5.8)**

***Risk Assessment Form***

Business Associate:
Scope of the work:
BA's Representative:
Telephone:
Signature:
Date:

Specific Task/Activity	Potential Hazards/Consequences	Class of Risk	Control Measures
Working at Height	Fall from height	2	<ol style="list-style-type: none"> <li>1. Mandatory usage of JSA checklist prior to start of work</li> <li>2. Use appropriate ladder</li> <li>3. Use full body safety harness having double lanyard.</li> <li>4. Use Electrical Safety Shoes if working on electrical network otherwise use safety shoes.</li> <li>5. Use Safety helmet.</li> <li>6. Use PPE as per the annexure 7 of this CSM document</li> <li>7. Refer Work instruction related to Working at Height for other details</li> <li>8. Use of metal scaffold to be ensured in height work (cup lock type)</li> <li>9. Deploy competent workforce who are medically fit</li> </ol>

GENERAL CONDITIONS OF CONTRACT - COMPOSITE WORKS

Specific Task/Activity	Potential Hazards/Consequences	Class of Risk	Control Measures
Working on electrical equipment / network	Electric flash / electrocution	3	<ol style="list-style-type: none"> <li>1. Mandatory usage of JSA checklist prior to start of work</li> <li>2. Use Electrical Safety Shoes while working on electrical network.</li> <li>3. Use Electrical Safety gloves of appropriate voltage rating.</li> <li>4. Use face shield / visor attached with helmet.</li> <li>5. Use Safety helmet.</li> <li>6. Use PPE as per the annexure 7 of this CSM document</li> <li>7. Mandatory usage of Insulated tools &amp; tackles on electrical system</li> <li>8. Mandatory compliance for Lock Out &amp; Tag out system. Refer Work instruction related to Working on electrical equipment / network for other details</li> </ol>
Excavation / Civil work	Collapse of soil, Fall in excavated pit leading to Injury	2	<ol style="list-style-type: none"> <li>1. Use safety shoes.</li> <li>2. Use Safety helmet.</li> <li>3. Use PPE as per the annexure 7 of this CSM document</li> <li>4. Hard Barricading of the worksite.</li> <li>5. Refer Work instruction related to excavation / civil work for other details</li> </ol>
Material lifting & Mechanical Erection work	Fall of material/object, Topple of crane,	2	<ol style="list-style-type: none"> <li>1. Mandatory compliance of crane checklist</li> <li>2. Visual condition check of lifting tools and tackles such as wire rope sling, belt sling, chain, pulley block, D-shackles, etc. shall be ensured.</li> <li>3. The operator's physical fitness and alertness should be judged by sup. / EIC.</li> <li>4. Use PPE as per the annexure 7 of this CSM document</li> <li>5. Refer Work instruction related to Material lifting &amp; Mechanical Erection work</li> </ol>
Road Safety	Road Accidents	3	<ol style="list-style-type: none"> <li>1. Mandatory compliance of TPCODL Road Safety policy W07(COR-P-12)</li> </ol>

Doc. Title	GENERAL CONDITIONS OF CONTRACT - COMPOSITE WORKS	
Rev. No	0	Page 81 of 104

Specific Task/Activity	Potential Hazards/Consequences	Class of Risk	Control Measures
------------------------	--------------------------------	---------------	------------------

*Note: This information for the general indication purpose. The detailed risk assessment shall be conducted before start of the work by the authorized representative of the BA. The report of same shall be submitted to engineer in-charge along with annexure 4 of the CSM document.*

### Guidelines for filling the Risk Assessment Form

- *Specific Task/Activity* - The documentation of each major task associated with the contract.
- *Potential Hazards* - The identification of hazards associated with each activity or task to be carried out.
- *Class of Risk* - Each hazard should be evaluated as a level of risk, described as Risk Class 1, 2 or 3 defined above.
- *Control Measure* - The identification and documentation of actions required to eliminate or reduce the hazards that could lead to accident or injury.

Hazard / Risks shall be classified according to the following schedule:

- Class 1: Potential to cause injury treatable with first aid
- Class 2: Potential to cause death or permanent injury
- Class 3: Potential to cause more than one or more lost time injuries.

Doc. Title	GENERAL CONDITIONS OF CONTRACT - COMPOSITE WORKS	
Rev. No	0	Page 82 of 104

### **Annexure 3.1 (Refer Para 4.0)**

#### **General Safety Conditions for the Maintenance of Distribution Network Contracts:**

A BA awarded a contract (O&M) work of maintenance of distribution network will be required to fulfil the following conditions:

- BA shall provide Safety Policy and safety objectives of their company.
- BA shall comply with all statutory requirements like: applicable acts, regulations, codes of practice, OHSAS Standards, etc.
- BA shall provide the filled safety management questionnaire as per Annexure 1
- BA shall conduct a job risk assessment and provide information as per Annexure 2
- BA shall abide by Safety manuals, guidelines of TPCODL.
- BA shall provide its organisation structure & responsibilities in terms of Safety Management to TPCODL.
- BA shall document the work practices and procedures in terms of Safety Management.
- BA shall ensure safety training and induction program for the employees
- BA shall conduct safety audits & inspections as per TPCODL procedures provided by SAFETY group.
- BA shall provide and ensure the proper usage of the safety equipment (PPE) as per the TPCODL approved list in *annexure 7*.
- BA shall ensure periodic inspection of PPE to ensure its serviceability as per the specification given by TPCODL.
- BA shall ensure the adherence to standard operating procedures or guidelines laid down by TPCODL.
- BA shall ensure reporting of any unsafe act, unsafe conditions, near miss, incident or accident to engineer in-charge and SAFETY team of TPCODL.
- BA shall provide safety performance and Safety MIS (*annexure 9*) to engineer in-charge and SAFETY group periodically. Based on any non-confirmation to the safety procedures and guidelines, BA is liable to be negatively marked for his performance and suitable penalty will be imposed.
- BA shall ensure to depute a Safety Supervisor for managing a complete safety management system in a district. In case the BA has been awarded work in more than one district, then the following safety structure will be adopted.





Doc. Title	GENERAL CONDITIONS OF CONTRACT - COMPOSITE WORKS	
Rev. No	0	Page 83 of 104

**Annexure 3.2 (Refer Para 4.0)**

**General Safety Conditions for the Distribution Projects Major Contracts:**

A BA awarded a major contract work of TS&P in area of a circle will be required to fulfil the following conditions:

- BA shall provide Safety Policy and safety objectives of their company.
- BA shall comply with all statutory requirements like: applicable acts, regulations, codes of practice, OHSAS Standards, etc.
- BA shall provide the filled safety management questionnaire as per Annexure 1.
- BA shall conduct a job risk assessment and provide information as per Annexure 2
- BA shall abide by Safety manuals, guidelines of TPCODL.
- BA shall provide its organisation structure & responsibilities in terms of Safety Management to TPCODL.
- BA shall document the work practices and procedures in terms of Safety Management.
- BA shall ensure safety training and induction program for the employees
- BA shall conduct safety audits & inspections as per TPCODL procedures provided by SAFETY group.
- BA shall provide and ensure the proper usage of the safety equipment (PPE) as per the TPCODL approved list in annexure 7.
- BA shall ensure periodic inspection of PPE to ensure its serviceability as per the specification given by TPCODL.
- BA shall ensure the adherence to standard operating procedures or guidelines laid down by TPCODL.
- BA shall ensure reporting of any unsafe act, unsafe conditions, near miss, incident or accident to engineer in-charge and SAFETY team of TPCODL.
- BA shall provide safety performance and Safety MIS (*annexure 9*) to engineer in-charge and SAFETY group periodically. Based on any non-confirmation to the safety procedures and guidelines, BA is liable to be negatively marked for his performance and suitable penalty will be imposed.
- BA shall ensure to depute a Safety Supervisor for managing a complete safety management system in the area. In case the BA has been awarded work in more than one circle, then the following safety structure will be adopted.

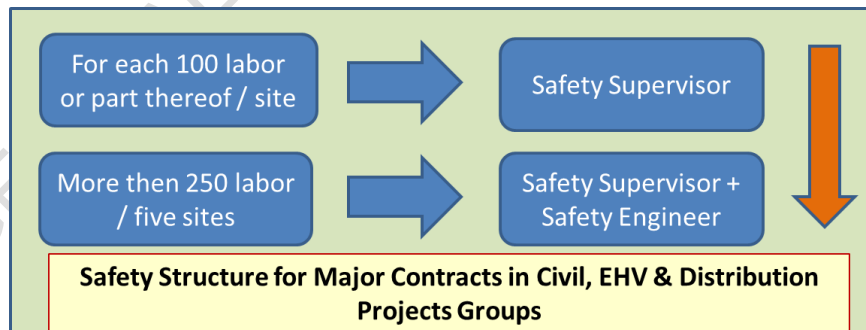

Doc. Title	GENERAL CONDITIONS OF CONTRACT - COMPOSITE WORKS	
Rev. No	0	Page 84 of 104

### **Annexure 3.3 (Refer Para 4.0)**

#### **General Safety Conditions for the major EHV Projects Contracts:**

A BA awarded a major contract work of EHV projects will be required to fulfil the following conditions:

- BA shall provide Safety Policy and safety objectives of their company.
- BA shall comply with all statutory requirements like: applicable acts, regulations, codes of practice, OHSAS Standards, etc.
- BA shall provide the filled safety management questionnaire as per Annexure 1
- BA shall conduct a job risk assessment and provide information as per Annexure 2
- BA shall abide by Safety manuals, guidelines of TPCODL.
- BA shall provide its organisation structure & responsibilities in terms of Safety Management to TPCODL.
- BA shall document the work practices and procedures in terms of Safety Management.
- BA shall ensure safety training and induction program for the employees
- BA shall conduct safety audits & inspections as per TPCODL procedures provided by SAFETY group.
- BA shall provide and ensure the proper usage of the safety equipment (PPE) as per the TPCODL approved list in annexure 7.
- BA shall ensure periodic inspection of PPE to ensure its serviceability as per the specification given by TPCODL.
- BA shall ensure the adherence to standard operating procedures or guidelines laid down by TPCODL.
- BA shall ensure reporting of any unsafe act, unsafe conditions, near miss, incident or accident to engineer in-charge and SAFETY team of TPCODL.
- BA shall provide safety performance and Safety MIS (*annexure 9*) to engineer in-charge and SAFETY group periodically. Based on any non-confirmation to the safety procedures and guidelines, BA is liable to be negatively marked for his performance and suitable penalty will be imposed.
- BA shall ensure to depute a Safety Supervisor for managing a complete safety management system in the area. In case the BA has been awarded work in more than one circle, then the following safety structure will be adopted.
- BA shall refer Construction Safety Manual in TPCODL Safety Manual for details.

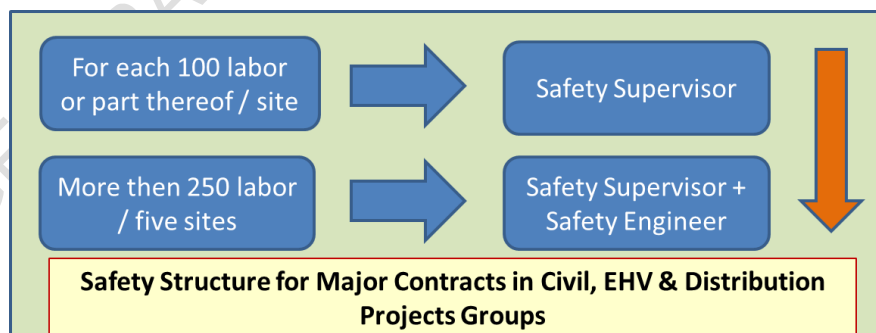

Doc. Title	GENERAL CONDITIONS OF CONTRACT - COMPOSITE WORKS	
Rev. No	0	Page 85 of 104

### Annexure 3.4 (Refer Para 4.0)

#### General Safety Conditions for the Maintenance of Sub – Transmission Network Contracts:

A BA awarded a major contract work of maintenance of sub – transmission network in area of a power system will be required to fulfil the following conditions:

- BA shall provide Safety Policy and safety objectives of their company.
- BA shall comply with all statutory requirements like: applicable acts, regulations, codes of practice, OHSAS Standards, etc.
- BA shall provide the filled safety management questionnaire as per Annexure 1
- BA shall conduct a job risk assessment and provide information as per Annexure 2
- BA shall abide by Safety manuals, guidelines of TPCODL.
- BA shall provide its organisation structure & responsibilities in terms of Safety Management to TPCODL.
- BA shall document the work practices and procedures in terms of Safety Management.
- BA shall ensure safety training and induction program for the employees
- BA shall conduct safety audits & inspections as per TPCODL procedures provided by SAFETY group.
- BA shall provide and ensure the proper usage of the safety equipment (PPE) as per the TPCODL approved list in annexure 7.
- BA shall ensure periodic inspection of PPE to ensure its serviceability as per the specification given by TPCODL.
- BA shall ensure the adherence to standard operating procedures or guidelines laid down by TPCODL.
- BA shall ensure reporting of any unsafe act, unsafe conditions, near miss, incident or accident to engineer in-charge and SAFETY team of TPCODL.
- BA shall provide safety performance and Safety MIS (*annexure 9*) to engineer in-charge and SAFETY group periodically. Based on any non-confirmation to the safety procedures and guidelines, BA is liable to be negatively marked for his performance and suitable penalty will be imposed.
- BA shall ensure to depute a Safety Coordinator for managing a complete safety management system in the area. In case the BA has been awarded work in more than one area power system, then the following safety structure will be adopted.



Doc. Title	GENERAL CONDITIONS OF CONTRACT - COMPOSITE WORKS	
Rev. No	0	Page 86 of 104

### Annexure 3.5 (Refer Para 4.0)

#### **General Safety Conditions for the major contract work in Civil / Generation Projects:**

A BA awarded a major contract work of / in civil or Generation project will be required to fulfil the following safety conditions:

- BA shall provide Safety Policy and safety objectives of their company.
- BA shall comply with all statutory requirements like: applicable acts, regulations, codes of practice, OHSAS Standards, etc.
- BA shall provide the filled safety management questionnaire as per Annexure 1
- BA shall conduct a job risk assessment and provide information as per Annexure 2
- BA shall abide by Safety manuals, guidelines of TPCODL.
- BA shall provide its organisation structure & responsibilities in terms of Safety Management to TPCODL.
- BA shall document the work practices and procedures in terms of Safety Management.
- BA shall ensure safety training and induction program for the employees
- BA shall conduct safety audits & inspections as per TPCODL procedures provided by SAFETY group.
- BA shall provide and ensure the proper usage of the safety equipment (PPE) as per the TPCODL approved list in annexure 7.
- BA shall ensure periodic inspection of PPE to ensure its serviceability as per the specification given by TPCODL.
- BA shall ensure the adherence to standard operating procedures or guidelines laid down by TPCODL.
- BA shall ensure reporting of any unsafe act, unsafe conditions, near miss, incident or accident to engineer in-charge and SAFETY team of TPCODL.
- BA shall provide safety performance and Safety MIS (*annexure 9*) to engineer in-charge and SAFETY group periodically. Based on any non-confirmation to the safety procedures and guidelines, BA is liable to be negatively marked for his performance and suitable penalty will be imposed.
- BA shall ensure to depute a Safety Supervisor (for workforce upto 100 at site) / a safety engineer (for workforce upto 250 at site) / safety manager (for more than two safety engineers) for managing a complete safety management system at the project site. In case the BA has been awarded more than one major contracts, then the following safety structure will be adopted.
- BA shall refer Construction Safety Manual in TPCODL Safety Manual for details.



Doc. Title	GENERAL CONDITIONS OF CONTRACT - COMPOSITE WORKS	
Rev. No	0	Page 87 of 104

**Annexure 3.6 (Refer Para 4.0)**

**General Safety Conditions for the major contract work in Commercial Department like - MMG, RRG, EAG, etc.:**

A BA awarded a major contract work in meter management group & energy auditing group will be required to fulfil the following safety conditions:

- BA shall provide Safety Policy and safety objectives of their company.
- BA shall comply with all statutory requirements like: applicable acts, regulations, codes of practice, OHSAS Standards, etc.
- BA shall provide the filled safety management questionnaire as per Annexure 1
- BA shall conduct a job risk assessment and provide information as per Annexure 2
- BA shall abide by Safety manuals, guidelines of TPCODL.
- BA shall provide its organisation structure & responsibilities in terms of Safety Management to TPCODL.
- BA shall document the work practices and procedures in terms of Safety Management.
- BA shall ensure safety training and induction program for the employees
- BA shall conduct safety audits & inspections as per TPCODL procedures provided by SAFETY group.
- BA shall provide and ensure the proper usage of the safety equipment (PPE) as per the TPCODL approved list in annexure 7.
- BA shall ensure periodic inspection of PPE to ensure its serviceability as per the specification given by TPCODL.
- BA shall ensure the adherence to standard operating procedures or guidelines laid down by TPCODL.
- BA shall ensure reporting of any unsafe act, unsafe conditions, near miss, incident or accident to engineer in-charge and SAFETY team of TPCODL.
- BA shall provide safety performance and Safety MIS (*annexure 9*) to engineer in-charge and SAFETY group periodically. Based on any non-confirmation to the safety procedures and guidelines, BA is liable to be negatively marked for his performance and suitable penalty will be imposed.
- BA shall ensure to depute a Safety Supervisor for managing a complete safety management system for the work as per the following safety structure.
- The BA for the RRG work shall depute one Safety supervisor.

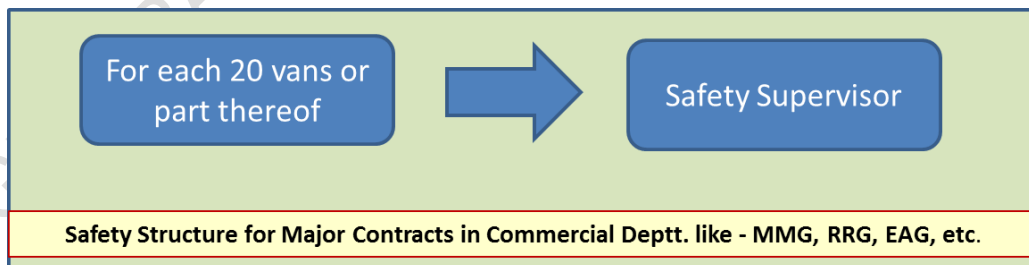

Doc. Title	GENERAL CONDITIONS OF CONTRACT - COMPOSITE WORKS	
Rev. No	0	Page 88 of 104

### **Annexure 3.7 (Refer Para 4.0)**

#### **General Safety Conditions for the major contract work in O&M of street light group:**

A BA awarded a major contract work in operation and maintenance of street light group will be required to fulfil the following safety conditions:

- BA shall provide Safety Policy and safety objectives of their company.
- BA shall comply with all statutory requirements like: applicable acts, regulations, codes of practice, OHSAS Standards, etc.
- BA shall provide the filled safety management questionnaire as per Annexure 1
- BA shall conduct a job risk assessment and provide information as per Annexure 2
- BA shall abide by Safety manuals, guidelines of TPCODL.
- BA shall provide its organisation structure & responsibilities in terms of Safety Management to TPCODL.
- BA shall document the work practices and procedures in terms of Safety Management.
- BA shall ensure safety training and induction program for the employees
- BA shall conduct safety audits & inspections as per TPCODL procedures provided by SAFETY group.
- BA shall provide and ensure the proper usage of the safety equipment PPE as per the TPCODL approved list in annexure 7.
- BA shall ensure periodic inspection of PPE to ensure its serviceability as per the specification given by TPCODL.
- BA shall ensure the adherence to standard operating procedures or guidelines laid down by TPCODL.
- BA shall ensure reporting of any unsafe act, unsafe conditions, near miss, incident or accident to engineer in-charge and SAFETY team of TPCODL.
- BA shall provide safety performance and Safety MIS (*annexure 9*) to engineer in-charge and SAFETY group periodically. Based on any non-confirmation to the safety procedures and guidelines, BA is liable to be negatively marked for his performance and suitable penalty will be imposed.
- Each BA shall ensure to depute a Safety Supervisor for managing a complete safety management system for the work awarded as per the below structure.



Doc. Title	GENERAL CONDITIONS OF CONTRACT - COMPOSITE WORKS	
Rev. No	0	Page 89 of 104

**Annexure 4 (Refer Para 3.3)**

**Safety Undertaking by way of Affidavit**

I \_\_\_\_\_ s/o \_\_\_\_\_ R/o \_\_\_\_\_ (AUTHORIZED REPRESENTATIVE/PARTNER/DIRECTOR/PROPRIETOR ) of M/S \_\_\_\_\_ (name of company/firm) having its office at (Complete address of Company), authorized vide power of attorney dated -----/Board resolution dated----/letter of authority dated----, hereinafter referred to as **Contractor [or Business Associate (BA)]** which expression shall, unless it be repugnant to or inconsistent with the meaning or context thereof, be deemed to include its heirs, executors, administrators, and assigns do hereby affirm and undertake as under :

1. The present undertaking shall remain in force from the date of execution of contract awarded by TPCODL and shall be valid till the date of termination of the said contract by either parties. The undertaking is binding on me (contractor) as well as my sub-contractor and its employees, representatives etc.
2. That I(the contractor) will be responsible and liable to comply and abide by all the safety rules, instructions and regulations as may be specified and laid down by The TP Central Odisha Distribution Limited (TPCODL) so as enable TPCODL to achieve its goal of Zero On site incidences.
3. That the Contractor shall be fully responsible for ensuring occupational health and safety of its employees, representatives, agents as well as of its subcontractor's employees, at all times during the discharge of their respective obligations under the contract including any methods adopted for performance of their tasks / work.
4. That Contractor shall ensure ,at its own expense to arrange for and procure, implement all requisite accident prevention tools, first aid boxes, personal protective equipment, fire extinguisher, safety training, Material Safety Data Sheet, pre-employment medical test, etc. for operations & activities including as & when so specified by TPCODL specifically. , failing which TPCODL shall be entitled, but not obliged, to provide the same and recover the actual cost thereof from the Contractor's payments.
5. That the Contractor shall engage adequate and competent Safety – Supervisor / Engineer / Manager / Skilled persons at site as per the Para 5 (Qualification and experience of safety personnel) and Annexure 3 of Contract Safety Management.
6. That the Contractor shall engage the competent Site – Supervisor with each group of workers for safe and correct workmanship, proper co-ordination of material and site work as per contract.

Doc. Title	GENERAL CONDITIONS OF CONTRACT - COMPOSITE WORKS	
Rev. No	0	Page 90 of 104

7. That the Contractor shall immediately replace supervisor in case it is found to be not up to the level of skill and experience required as in skill and experience required in *annexure 5* of this document, but any such replacement shall be only with the prior concurrence of TPCODL .
8. That the Contractor and its subcontractors shall abide by all the safety guidelines as per Safety Manual, Contract Safety Management and other guidelines issued from time to time by TPCODL during the contract period.
9. That in case the Contractor and/or any of its Subcontractor fail to ensure the compliance as required in terms of this undertaking the Contractor shall keep and hold TPCODL / its directors / officers / employees indemnified against any / all losses / damage / expense / liability / fines / compensation / claims / action / prosecutions or the like which might be suffered by TPCODL or to which TPCODL might get exposed to as a result of any breach /wilful negligence /deliberate default on the part of the Contractor /Subcontractor in complying with the same. Contractor shall also furnish any press release, clarification etc. if sought by TPCODL for any near miss or safety violations, accidents, which are attributable to fault of Contractor.

DEPONENT

VERIFICATION

Verified at Bhubaneswar on this      Day of      20     that the contents of the above affidavit are true and correct and nothing material has been concealed therefrom

DEPONENT



Doc. Title	GENERAL CONDITIONS OF CONTRACT - COMPOSITE WORKS	
Rev. No	0	Page 91 of 104

**Annexure 5 (Refer Para 5.4)**

**SKILL / QUALIFICATION REQUIRED FOR ELECTRICIAN AND ELECTRICAL SUPERVISOR**

**Skill / Qualifications Required for Electrician (*Certificate of Competency Class-II*):**

1. Formal education in ITI – Wireman/ Electrician trade.

OR

2. Working experience of minimum three years of practical wiring.

OR

3. Have completed three years apprenticeship course through Apprenticeship Advisor, Govt. of Odisha / other state Govt. in the trade of Lineman / Wireman / Electrician.
4. A candidate must have attained the age of Eighteen years.

**Skill / Qualifications Required for Electrical Supervisor (*Certificate of Competency Class-I*):**

1. Have at least five years' experience of practical wiring after passing the certificate of competency class-II i.e. electrician.

OR

2. Recognized Degree or Diploma or equivalent qualification in Electrical Engineering from any Technical institute / College or University recognized by the Board.

AND

Must have completed the training/job in rectifying the common defects in electrical line and power installation for a period of one and three years after passing Degree or Diploma respectively

OR

3. Possessing the valid certificate of certificate of competency class – 1 (Electrical Supervisor)

Doc. Title	GENERAL CONDITIONS OF CONTRACT - COMPOSITE WORKS	
Rev. No	0	Page 92 of 104

## **Annexure 6 (Refer Para 5.6)**

### **Training Module for BAs Worker & Supervisor**

#### **Training for BA Supervisor**

**Duration – 02 Hrs / Month**

**Methodology:** Lecture and Practical Demonstration of Safety Zone Creation

#### **Session: 1**

**Topic:** Electrical Safety Aspects

#### **Sub Topics:**

1. Learning specifics of HT & LT Network of zone
2. Major type of HT / LT / service lines / street light maintenance works
3. Understanding the need of Safety
4. Understanding the safe process of maintenance :
  - Planning of the maintenance job
  - Availability of men, material & machine, PPEs, Safety gear and approved PTW
  - Briefing of the job by the supervisor of the TPCODL
  - Identification of Risks associated with the maintenance work and planning for controlling measures by TPCODL supervisor
  - Creation of safety zone by TPCODL supervisor and satisfying that the network is dead – Use of Neon Tester, Shorting Chain and Safety Tagging
  - Start of the work – Right person for the right job
  - Alert supervision
  - Completion of the job – Check points
  - Energization of network
  - Actions to be taken in case of some accident

#### **Session: 2**

**Topic:** Use of Electrical Testing Equipment

**Methodology:** Lecture and Practical Demonstration

#### **Sub Topics:**

1. Meggar, Hi Pot, Clamp On Meter, Neon Tester, Discharge Rod, Line tester etc.

#### **Session: 3**

**Topic:** Awareness of Electrical Safety Aspects

- A. Understanding the need of this Training and Safety
- B. Learning specifics of HT & LT Network
- C. Major type of work to be carried out in zones
- D. Switching Operations (Do's & Don'ts) including Street Light Switching
- E. Working on Height (*practical demo also*)
- F. Understanding the Safe Process of Maintenance / Working:
  - Planning of the job
  - Availability of men, material & machine, PPEs, Safety gear and approved PTW
  - Briefing of the job by the supervisor
  - Permit to Work
  - Safety Tagging and Lock Out Tag out

Doc. Title	GENERAL CONDITIONS OF CONTRACT - COMPOSITE WORKS	
Rev. No	0	Page 93 of 104

- Identification of Risks associated with the work to be carried out and planning for controlling measures by proper supervision
- Concept of "**Safety Zone**"
- Identification and use of Neon Tester, Shorting Chain, Clamp On Meter, Hi Pot, Meggar etc.
- Completion of the job – Check points
- Accident Theory & Incident Reporting
- Actions to be taken in case of some accident

#### **Session: 4**

**Topic: Identification, Demonstration and Usages of Tools, PPEs and other Safety Gears and demonstration of working on HT pole**

#### **Session: 5**

**Topic: Practical demonstration of Safety Zone creation**

### **FREQUENCY**

#### **Regular Safety Training Program**

- It will be conducted for all field & supervisor staff of BA in such a manner that all BA Personnel attend at least two hours safety training during every month.

#### **One Day Induction Safety Training Programs:**

- This training will be for the new BA's personnel, who have been cleared by the Cross Functional Panel to undergo Safety training and who are likely to be deployed at various work sites of TPCODL by the BA, as a part of AMC / Work Contract.

#### **Duration / Periodicity:**

- Duration and periodicity has been defined above. However, this is subject to change at the discretion of TPCODL.

Doc. Title	GENERAL CONDITIONS OF CONTRACT - COMPOSITE WORKS	
Rev. No	0	Page 94 of 104

**Annexure 7 (Refer Para 5.7)**



**LIST OF PERSONAL PROTECTIVE EQUIPMENT AND TESTING FREQUENCY**

Sl. No.	Name of PPE	IS / EN Standard	Testing Frequency	Remarks	Ref Brand & Model
01	Leather Safety Shoes (Color – Black) with PU toe cap.	IS:15298 (Part-2)	Monthly and visual check every day for any crack or damage in the leather or sole.		BATA (Model No.- Endura L/C)  Liberty (Model No. – 7198-01 HT Barton Black – Warrior)
02	HDPE Safety helmet with chin strap and ratchet type for adjustment.	IS:2925-1984	Monthly and visual check every day for any crack in shell.		Karam (PN Safetech )  Joseph Leslie  Accent Industries  Honeywell
03	Full body harness (Safety belt)	EN 361	Monthly and visual check every day of the bends and the harness.		Karam (PN Safetech )  Joseph Leslie  Accent Industries
04	Electrical Safety Gloves	EN: 60903 CE marked	Weekly and visual check for any crack and blow test before every work.	Manufactured not beyond 12 months.	Make Sparian / Sumitech / CATU supplied with inner cotton glove with over glove of split leather.
05	Full face visor with safety helmet	EN: 166 CE marked (Visor)	Monthly and visual check every day for any crack in shell.	Clear acrylic visor attached with safety helmet.	Karam (PN Safetech )  Joseph Leslie  Accent Industries  Honeywell
06	Fire Proof jacket for chest protection		Monthly and visual check every day.		
07	Safety Chain for shorting cum earthing.	As per TPCODL standard	Weekly and visual check before every work.	Made of brass, Total length – 5.5 meters and made of 12 SWG.	

*Note:*

1. Any other Personal Protection Equipment required beyond above list will be according to BIS or EN Standards.
2. All Personal Protection Equipment will be checked by the engineer in-charge or SAFETY group of TPCODL.
3. Safety Representative of the BA has to maintain the record of the availability, condition and checking of the PPEs.
4. All tools required as per the contract must be according to respective IS / EN standards.
5. TPCODL may revise or add the above list of PPE and their specifications as and when feel necessary. The information about new specifications /models will be circulated by the Engineer In-charge (EIC), which shall adhere by the business associated in the shortest possible time. The EIC shall issue a memo / instruction to BA with timeline for implementation. Any delay will be treated as non- compliance / safety violations. Refer picture of each PPE given in next page.

**Pictures of PPE for reference purpose.**

Sl. No.	Name of PPE	IS / EN Standard	Picture
01	Leather Safety Shoes (Color – Black) with PU toe cap.	IS:15298(Part-2) and with test report of electrical resistance.	
02	HDPE Safety helmet with chin strap and ratchet type for adjustment.	IS:2925-1984	
03	Full body harness (Safety belt)  The straps at shoulder and thigh shall have full pad for comfort. The back shall be so designed that harness straps do not tangle with each other.	EN 361:2002 EN 358 : 2000 IS: 3521:1991/2002	

04	Electrical Safety Gloves – Composite type Soft electrical gloves as per size of individual.	EN: 60903 CE marked	
05	Full face visor with safety helmet	EN: 166 CE marked (Visor)	
06	Fire Proof jacket for chest protection		
07	Safety Chain for shorting cum earthing.	As per TPCODL standard	
08	Reflective jacket to each workmen	As per TPCODL standard	

Note : Picture shown are for indicative purpose only. Actual product may differ.

**Annexure 8 (Refer Para 5.8) LIST OF AUDITS TO BE CONDUCTED**

Audits	Responsibility	Freq.	Ref. Doc.
Permit to Work & Field Audit	BA Safety Representative	Weekly	F04 (COR P - 12)
Tool Bag & PPE's Audit		Weekly	F06 (COR P - 12)
First Aid Box Maintenance Record		Fortnightly	F08 (COR P - 12)
Fire Extinguisher Record <i>(Applicable for the BA involved in major construction works and have storage of flammable material at worksite)</i>		Monthly	F09 (COR P - 12)
Safety Talk Register		Weekly	F18 (COR P - 12)
Site Safety Audit		Daily	F29A (COR P - 12)

Note:

1. (BA Safety Representative has to use the formats as per Safety process COR – P – 12 of TPCODL)

Doc. Title	GENERAL CONDITIONS OF CONTRACT - COMPOSITE WORKS	
Rev. No	0	Page 98 of 104

**Annexure 9 (Refer Para 5.9)**

**PERFORMANCE REPORT – SAFETY**

**FOR THE MONTH OF.....**

Name of BA : .....

Name of the Project and Purchase order No: .....

Date of commencement of work: .....

Man Hour Worked in this month (No. of employees X 8 Hrs + Overtime): .....

Cumulative Man Hour worked: .....

Total Number of Minor Injury (this month): ..... Minor Injury (Total).....

Major Injury (this month): ..... Major Injury (Total): .....

**Detail of the Incident / Sub Standard Acts and Condition**

Activity	This Month	Cumulative (Total)	Day Lost (this month)	Days Lost (Cumulative)
No. of the Incident				
No. of lost time injuries				
No. of dangerous occurrences				
No. of near miss reported				
Substandard Act/Conditions observed			Attach details of observation of this month	
Safety Violation Notice received (from TPCODL) (both in numbers and in Rs.)	No.	No.	No. of violation letter received and compliance report for the TPCODL.	
	Rs.	Rs.		

*Note: Cumulative means total from date of commencement of work according to the contract.*

**Detail of the Accident / Near Miss Incidents:**

Date and Time	Type of the incident	Name of Employee	Brief Description	Corrective and Preventive actions recommended

**Details of the Safety Violations:**



Doc. Title	GENERAL CONDITIONS OF CONTRACT - COMPOSITE WORKS	
Rev. No	0	Page 99 of 104

Date and Location	Brief Description	Name of employee involved	Action Taken

Detail of the Safety Talk / Tool Box Talk / Safety Training

Date and Location	Topic (s)	Total Number of employees (Worker / Supervisor)	Number of participants (Worker / Supervisor)

Detail of the Safety Meeting

Date and Location	Number of participants	Topics discussed	Major Observations / Innovation

Detail of the Safety Inspection /Audit: (as per TPCODL site audit checklist F29A(COR-P-12))

Date	Area / Location	Major Observations	Recommendations	Action Taken

Any other Safety, Occupational Health, Environment & Disaster Management Promotional Activity (During this month):

Date	Location	Activity	Level of Participation	Number of participation

Signature of the BA Safety Representative  
HoG

Signature of ZM /

Name, E. No. and Date

Name, E. No. Date.

*Note: The original form to be deposited with Engineer in-charge and a copy to SAFETY group on or before 5<sup>th</sup> of every month along with bill. List of training of the current month and status of PPE to be also mentioned individual wise.*

*BA may include additional lines if required. The TPCODL may revise the format as and when deemed required.*

Doc. Title	GENERAL CONDITIONS OF CONTRACT - COMPOSITE WORKS	
Rev. No	0	Page 100 of 104

**ANNEXURE-M**  
**VENDOR APPRAISAL FORM**

<b>TO BE SUBMITTED BY VENDOR (To be filled as applicable)</b>			
<b>VENDOR:</b>			
<b>1.0</b>	<b>DETAILS OF THE FIRM</b>		
	1.1	NAME (IN CAPITAL LETTERS)	:
	1.2	TYPE OF CONCERN (PROPRIETARY) Partnership, Pvt. Ltd., Public Ltd. etc.	:
	1.3	YEAR OF ESTABLISHMENT	:
	1.4	LOCATION OF OFFICE POSTAL ADDRESS TELEGRAPHIC ADDRESSES, TELEX NO. FAX NO.	:
	1.5	LOCATION OF MANUFACTURING UNITS	:
		i) UNITS 1	:
		ii) OTHER UNITS	:
<b>2.0</b>	<b>PRODUCTS MANUFACTURED</b>		
<b>3.0</b>	<b>TURNOVER DURING THE LAST 3 YEARS (TO BE VERIFIED WITH THE LATEST PROFIT &amp; LOSS STATEMENT).</b>		
<b>4.0</b>	<b>VALUE OF FIXED ASSETS</b>		
<b>5.0</b>	<b>NAME &amp; ADDRESS OF THE BANKERS</b>		
<b>6.0</b>	<b>BANK GUARANTEE LIMIT</b>		
<b>7.0</b>	<b>CREDIT LIMIT</b>		
<b>8.0</b>	<b>TECHNICAL</b>		
	8.1	NO.OF DESIGN ENGINEERS (INDICATE NO.OF YEARS EXPERIENCE IN RELATED FIELDS)	:
	8.2	NO.OF DRAUGHTSMEN	:
	8.3	COLLABORATION DETAILS (IF ANY)	:
		8.3.1 DATE OF COLLABORATION	:
		8.3.2 NAME OF COLLABORATOR	:

Doc. Title	GENERAL CONDITIONS OF CONTRACT - COMPOSITE WORKS	
Rev. No	0	Page 101 of 104

		8.3.3 RBI APPROVAL DETAILS	:
		8.3.4 EXPERIENCE LIST OF COLLABORATOR	:
		8.3.5 DURATION OF AGREEMENT	:
	8.4	AVAILABILITY OF STANDARDS / DESIGN PROCEDURES / COLLABORATOR'S / DOCUMENTS (CHECK WHETHER THESE ARE LATEST/CURRENT)	:
	8.5	TECHNICAL SUPPORT, BACK-UP GUARANTEE, SUPERVISION, QUALITY CONTROL BY COLLABORATOR (WHEREVER ESSENTIAL). (THIS CLAUSE IS RELEVANT WHEN VENDOR'S EXPERIENCE IS INADEQUATE)	:
	8.6	QUALITY OF DRAWINGS	:
<b>9.0</b>	<b>MANUFACTURE</b>		
	9.1	SHOP SPACE, LAYOUT LIGHTING, VENTILATION, ETC.	:
	9.2	POWER (KVA)	:
		MAINS INSTALLED	:
		UTILISED	:
		STANDBY POWER SOURCE	:
	9.3	MANUFACTURING FACILITIES (ATTACH LIST OF EQUIPMENT AS APPLICABLE)	:
		9.3.1 MATERIAL HANDLING	:
		9.3.2 MACHINING	:
		9.3.3 FABRICATION	:
		9.3.4 HEAT TREATMENT	:
		9.3.5 BALANCING FACILITY	:
		9.3.6 SURFACE TREATMENT PRIOR TO PAINTING/ COATING, POLISHING, PICKLING, PASSIVATION, PAINTING, ETC.	:
	9.4	SUPERVISORY STAFF	:
	9.5	ADEQUACY OF SKILLED LABOURS (MACHINISTS, WELDERS, ETC.)	:
	9.6	NO. OF SHIFTS	:
	9.7	TYPE OF MATERIAL HANDLED (SUCH AS CS, SS, ETC.)	:

Doc. Title	<b>GENERAL CONDITIONS OF CONTRACT - COMPOSITE WORKS</b>	
Rev. No	0	Page 102 of 104

	9.8	WORKMANSHIP	:
	9.9	MATERIAL IN STOCK AND VALUE	:
	9.10	TRANSPORT FACILITIES	:
	9.11	CARE IN HANDLING	:
<b>10.0</b>	<b>INSPECTION / QC / QA / TESTING</b>		
	10.1	NUMBER OF PERSONNEL (INDICATE NO.OF YEARS OF EXPERIENCE)	:
	10.2	INDEPENDENCE FROM PRODUCTION	:
	10.3	AVAILABILITY OF PROCEDURAL WRITE UP/QUALITY PLAN	:
	10.4	INCOMING MATERIAL CONTROL AND DOCUMENTATION	:
	10.5	RELIABILITY/REPUTATION OF SUPPLY SOURCES	:
	10.6	STAGE INSPECTION AND DOCUMENTATION	:
	10.7	SUB-ASSEMBLY & DOCUMENTATION	:
	10.8	FINAL INSPECTION AND DOCUMENTATION	:
	10.9	PREPARATION OF FINAL DOCUMENTATION PACKAGE	:
	10.10	TYPE TEST FACILITIES	:
	10.11	ACCEPTANCE TEST FACILITIES	:
	10.12	CALIBRATION OF INSTRUMENTS AND GAUGES (WITH TRACEABILITY TO NATIONAL STANDARDS) (ATTACH LIST)	:
	10.13	STATUTORY APPROVALS LIKE BIS, IBR, ETC.(AS APPLICABLE)	:
	10.14	SUB-VENDOR APPROVAL SYSTEM AND QUALITY CONTROL	:
	10.15	DETAILS OF TESTS CARRIED OUT AT INDEPENDENT RECOGNISED LABORATORIES	:
		i) FURNISH LIST OF TESTS CARRIED OUT AND THE NAME OF THE LABORATORY WHERE THE TESTS WERE CONDUCTED	:
		ii) CHECK AVAILABILITY OF CERTIFICATES AND REVIEW THESE WHEREVER POSSIBLE	:
<b>11.0</b>	<b>EXPERIENCE (INCLUDING CONSTRUCTION / ERECTION / COMMISSIONING) TO BE FURNISHED IN THE FORMAT INDICATED IN APPENDIX)</b>		
<b>12.0</b>	<b>SALES, SERVICE AND SITE ORANISATIONAL DETAILS</b>		

Doc. Title	GENERAL CONDITIONS OF CONTRACT - COMPOSITE WORKS	
Rev. No	0	Page 103 of 104

13.0	<b>CERTIFICATE FROM CUSTOMERS (ATTACH COPIES OF DOCUMENTS)</b>	:
14.0	<b>POWER SITUATION</b>	:
15.0	<b>LABOUR SITUATION</b>	:
16.0 *	<b>APPLICABILITY OF SC/ST RELAXATION (Y/N) IF YES, SUPPORTING DOCUMENTS TO BE ATTACHED</b>	
17.0	<b>ORGANIZATIONAL DETAILS</b> 1. PF NO 2. ESI NO 3. INSURANCE FOR WORK MAN COMPENSATION ACT NO 4. ELECTRICAL CONTRACT LIC NO 5. ITCC / PAN NO 6. SALES TAX NO 7. WC TAX REG. NO	:
18.0	<b>DOCUMENTS TO BE ENCLOSED:</b> 1. FACTORY LICENSE 2. ANNUAL REPORT FOR LAST THREE YEARS 3. TYPE TEST REPORT FOR THE ITEM 4. PAST EXPERIENCE REPORTS 5. ISO CERTIFICATE –QMS, EMS, OHAS, SA 6. REGISTRATION OF SALES TAX 7. COPY OF TIN NO. 8. COPY OF SERVICE TAX NO. 9. REGISTRATION OF CENTRAL EXCISE 10. COPY OF INCOME TAX CLEARANCE. 11. COPY OF PF REGISTRATION 12. COPY OF ESI REGISTRATION 13. COPY OF INSURANCE FOR WORK MAN COMPENSATION ACT NO 14. COPY OF ELECTRICAL CONTRACT LIC NO 15. COPY OF PAN NO 16. COPY OF WC TAX REGISTRATION 17. DOCUMENTS IN SUPPORT OF SC/ST RELAXATION AT S.NO.16.0 18. GST Registration No	

\* **Classification of BA s under SC/ST shall be governed under following guidelines:**

- **Proprietorship/ Single Ownership Firm:** Proprietor of the firm should be from SC/ST community. Governing document shall be Proprietorship Deed.
- **Partnership Firm:** Only such firms shall qualify which have SC/ST partners holding equal to or more than 50% of the total ownership pattern of the firm. Governing document shall be Partnership Deed.
- **Private Limited Company:** Only such firms shall qualify which have SC/ST directors holding equal to or more than 50% of the total ownership pattern of the firm. Governing document shall be Memorandum of Understanding (MoU) and/or Article of Association (AoA).

**NOTE: Certification from SC/ST Commission shall be required for deciding upon SC/ST status of a person.**

Doc. Title	GENERAL CONDITIONS OF CONTRACT - COMPOSITE WORKS	
Rev. No	0	Page 104 of 104

**ANNEXURE-N**  
**MANUFACTURER AUTHORIZATION FORM**

*(To be submitted on OEM's Letter Head)*

Date: .....

Tender Enquiry No.: .....

To,

Chief (Procurement & Stores)

TP Central Odisha Distribution Limited,  
Bhubaneswar

Sir,

WHEREAS M/s. *[name of OEM]*, who are official manufacturers of ..... having factories at *[address of OEM]* do hereby authorize M/s *[name of bidder]* to submit a Bid in relation to the Invitation for Bids indicated above, the purpose of which is to provide the following Goods, manufactured by us

.....

and to subsequently negotiate and sign the Contract.

We hereby extend our full guarantee and warranty in accordance with the Special Conditions of Contract or as mentioned elsewhere in the Tender Document, with respect to the Goods offered by the above firm in reply to this Invitation for Bids.

We hereby confirm that in case, the channel partner fails to provide the necessary services as per the Tender Document referred above, M/s *[name of OEM]* shall provide standard warranty on the materials supplied against the contract. The warranty period and inclusion / exclusion of parts in the warranty shall remain same as defined in the contract issued to their channel partner against this tender enquiry.

Yours Sincerely,

For .....

Authorized Signatory