

TPCODL

TP Central Odisha Distribution Limited

TPNODL

TP Northern Odisha Distribution Limited

TPSODL

TP Southern Odisha Distribution Limited

TPWODL

TP Western Odisha Distribution Limited

CENTRALIZED CONTRACTS GROUP

NIT No.: TPCODL/CCG/23-24/019

Open Tender Notification**for****Rate Contract for Supply of AB Switches of various ratings
for TPCODL, TPNODL, TPWODL & TPSODL****Tender Enquiry No.: TPCODL/CCG/23-24/019,
Due Date for Bid Submission: 17th July 2023 [15:00 Hrs.]****Centralized Contracts Group
TP Central Odisha Distribution Limited
(A TATA Power and Odisha Government Joint Venture)****1st Floor, Anuj Building, Plot No. 29, Satya Nagar,
Bhubaneswar – 751007**

CENTRALIZED CONTRACTS GROUP

NIT No.: TPCODL/CCG/23-24/019

Tender Enquiry No.	Work Description	EMD (Rs.) *	Tender Fee inclusive of GST (Rs.) **	Last Date and Time for payment of Tender Fee
TPCODL/CCG/23-24/019	Rate Contract for Supply of AB Switches of various ratings for TPCODL, TPNODL, TPWODL & TPSODL	10 Lakhs	5,000	07.07.2023, 15:00 Hrs

* EMD is exempted for MSMEs registered in the State of Odisha.

** MSMEs registered in the State of Odisha shall pay tender fee of Rs. 1,000/- including GST. For details of MSME norms, pls refer "Annexure A" below.

INFORMATION TO THE BIDDERS TO PARTICIPATE IN E-OPEN TENDER SYSTEM OF TPCODL

-: Steps for E-tender submission:-

Bids are to be submitted only through online e-procurement platform, ARIBA. Any other form of bid submission will not be accepted. Online Link for submission of bid through ARIBA will be sent only after confirmation of payment of tender fee from bidder.

Step 1: The bidder can get primary information about the tender from the Newspaper advertisement / TPCODL/TPWODL/TPNODL/TPSODL website <www.tpcentralodisha.com> and can download the tender document from the above website.

Step 2: Non-Refundable Tender Participation Fee, as indicated in tender document, to be submitted before last date of tender fee payment, in the form of direct deposit/NEFT/RTGS in the following bank account.

Account Name: TP Central Odisha Distribution Limited
Bank Name: State Bank of India,
IDCO Towers, Bhubaneswar
Bank Account No. : 10835304915
IFSC Code : SBIN0007891

Step 3: Eligible and Interested bidder to send an email to TPCODL attaching duly signed and stamped letter on Bidder's letterhead, with following details, expressing their intend to bid against above tender:

CENTRALIZED CONTRACTS GROUP

NIT No.: TPCODL/CCG/23-24/019

SI No	Description	Bidder's Response
i)	Tender Enquiry No.	
ii)	Description of materials / Works Tendered	
iii)	Name and address of the bidding company	
iv)	Name of the authorized contact person	
v)	Contact No. authorized person	
vi)	E-mail Id of the where online ARIBA link to be sent	
vii)	Tender Fee details (Amount / NEFT-RTGS UTR No	
viii)	GST No.of bidder	
ix)	MSME Certificate, wherever applicable	
x)	Postal address of bidder for return of EMD BG	

E-mail has to be sent to <santanu.mukherjee@tpnodl.com> with copy to <vipin.chauhan@tpnodl.com> before "Last date and time for payment of Tender Participation Fee".

Step 4: On receipt of the document as mentioned in Step 3 above and after due verification of the same, ARIBA link for participation in the tender will be sent to bidder's mail address from ARIBA system.

Step 5: In this mail there will be an online link as **Click Here** to participate in the tender.

Step 6: Click "**Click Here**" to access this event.

Step 7: If bidder is bidding first time for CCG through ARIBA site then please "Sign UP" by creating User Name and password as mentioned in Sign Up page. Please follow the process, as mentioned in the Sign Up page, during creation of User Name and password. Also a simple one-page registration screen will open for first time user. All * mark mandatory field to be filled in.

Those who are already having User Name and password for accessing TPCODL events, they can LOGIN using same User Name and password.

If bidder has got User name and password for their other customer, same will not be applicable for TPCODL/TPWODL/TPNODL/TPSODL

Step 8: You will be able to see the RFQ

Step 9: After review and downloading of all documents click on "**Review Pre-requisites**"

Step 10: Review and accept "**Bidder Agreement**".

Step 11: You can see attached pdf tender document against clause no 1.1.1 (Introduction).

Step 12: Vendor has to attach pdf version of technical bid in clause no. 2.1 and 2.2. In this field do not attach any price document.

TPCODL

TP Central Odisha Distribution Limited

TPNODL

TP Northern Odisha Distribution Limited

TPSODL

TP Southern Odisha Distribution Limited

TPWODL

TP Western Odisha Distribution Limited

CENTRALIZED CONTRACTS GROUP

NIT No.: TPCODL/CCG/23-24/019

Price schedule is attached in clause no.3.2. Same has to be downloaded and price and tax details to be filled in as per the format given, print to be taken in vendor's letter head and signature and seal to be made by authorised person. PDF version of this price bid to be attached in clause 3.2 For Price Bid put all the unit price and taxes and duties in provided field. Put "0" (ZERO) in not applicable field.

Step 13: After successfully putting Techno commercial offer and price part then click on **"Submit Entire Response"**

Note: Once user ID and password created, bidder can also login to ARIBA site through the following URL:

CENTRALIZED CONTRACTS GROUP

NIT No.: TPCODL/CCG/23-24/019

Annexure-A**Preferential norms for procurement from MSMEs registered in the State of Odisha****1) Tender Fees**

To participate in the tender, MSMEs registered in the State of Odisha shall pay Rs.1,000/- including GST towards cost of tender paper.

2) Earnest Money Deposit (EMD)

EMD shall be exempted for MSME registered in the State of Odisha. However, Bidder shall be barred to participate in the tendering process for a period of 2 years in case it backs out post award of the contract.

3) Qualification Requirement for Open Tenders

Qualification Requirement of Financial Turnover for MSME registered in the State of Odisha shall be reduced to 20% of the existing criteria.

For past experience, instead of relying on the volumes / value of earlier Supplies / Projects, assessment of the Bidder shall be done on the basis of feedback from Customers. Past performance experience at Tata Power and its Group Companies shall supersede feedback from other Customers.

4) Reservation for MSME

It shall be mandatory to procure at least 20% of the total volume of the procurement from MSME registered in the State of Odisha (however, it shall not apply where goods/services are not available with the MSME), subject to matching L1 discovered prices and meeting technical specifications including quality requirements.

5) Performance Bank Guarantees

Performance Bank Guarantee for MSME registered in the State of Odisha shall be 25% of the value normally prescribed.

CENTRALIZED CONTRACTS GROUP

NIT No.: TPCODL/CCG/23-24/019

CONTENTS OF THE ENQUIRY

S. NO.	PARTICULARS
1.	Event Information
2.	Submission of Bid Documents
3.	Bid Opening & Evaluation process
4.	Evaluation Criteria
5.	Award Decision
6.	Order of Preference/Contradiction
7.	Post Award Contract Administration
8.	Specifications and Standards
9.	General Conditions of Contract
10.	Safety
Annexures	
I	Annexure I – Schedule of Items
II	Annexure II – Specification, drawing and GTP
III	Annexure III – Schedule of Deviations
IV	Annexure IV – Schedule of Commercial Specifications
V	Annexure V – Document Check List
VI	Annexure VI – Acceptance Form for Participation in Reverse Auction Event
VII	Annexure VII – General Condition of Contract
VIII	Annexure VIII – Safety Policy and Safety Terms and Conditions
IX	Annexure IX - Environment & Sustainability Policy
X	Annexure X – Tata Code of Conduct (TCOC)

CENTRALIZED CONTRACTS GROUP

NIT No.: TPCODL/CCG/23-24/019

Definition & Introduction of Centralized Contracts Group

The Centralized Contracts Group (CCG) is a shared group of 4 Discom (TPCODL, TPNODL, TPSODL & TPWODL) in Odisha. The contract finalized by CCG shall be used by 4 Discoms to execute the work.

1.0 Event Information

1.1. Scope of work

Bids are invited from interested Bidders to award contract for Procurement of AB Switches as mentioned below:

ITEM DESCRIPTION	UOM	TPNODL QTY.	TPSODL QTY.	TPCODL QTY.	TPWODL QTY.	TOTAL QTY.
AB S/W 11KV 200A 3 POLE HORIZONTAL	EA	8,345	9,597	800	4,500	23,241
AB S/W 33KV 400A 3 POLE GANG OPE. HORIZONTAL	EA	600	690	200	1,000	2,490
AB S/W 11KV 400A 3 POLE HORIZONTAL	EA	1,200	1,380	-	6,760	9,340

1.2. Availability of Tender Documents

Please refer "Procedure to participate in the e-tender".

1.3. Calendar of Events

(a)	Date of availability of tender documents from TPCODL Website	01.07.2023
(b)	Last date and time of Payment of Tender Fee	07.07.2023, 15:00 Hours
(c)	Last Date of receipt of pre-bid queries, if any	07.07.2023, 17:00 Hours
(d)	Last Date of Posting Consolidated replies to all the pre-bid queries as received	12.07.2023
(e)	Last date and time of receipt of Bids	17.07.2023, 15:00 Hours

Note: In the event of last date specified for submission of bids and date of opening of bids is declared as a closed holiday for TPCODL's office, the last date of submission of bids and date of opening of bids will be the day following working day at appointed times.

CENTRALIZED CONTRACTS GROUP

NIT No.: TPCODL/CCG/23-24/019

1.4 Mandatory documents required along with the Bid

- 1.4.1 EMD of requisite value and validity
- 1.4.2 Tender Fee.
- 1.4.3 Requisite Documents for compliance to Qualification Criteria mentioned in Clause 1.7.
- 1.4.4 Acceptance of Specification, drawing with filled in GTP as per Annexure II.
- 1.4.5 Duly signed and stamped 'Schedule of Deviations' as per Annexure III on bidder's letter head.
- 1.4.6 Duly signed and stamped 'Schedule of Commercial Specifications' as per Annexure IV on bidder's letter head.
- 1.4.7 Duly filled in Annexure V and VI.
- 1.4.8 Proper authorization letter/ Power of Attorney to sign the tender on the behalf of bidder.
- 1.4.9 Copy of PAN, GST registration (In case any of these documents is not available with the bidder, same to be explicitly mentioned in the 'Schedule of Deviations')

Please note that in absence of any of the above documents, the bid submitted by a bidder shall be liable for rejection.

1.5. Deviation from Tender

Normally, the deviations to tender terms are not admissible and the bids with deviation are liable for rejection. Hence, the bidders are advised to refrain from taking any deviations on this Tender. Still in case of any deviations, all such deviations shall be set out by the Bidders, clause by clause in the 'Annexure III - Schedule of Deviations' and same shall be submitted as a part of the Technical Bid.

1.6. Right of Acceptance/Rejection

Bids are liable for rejection in absence of following documents:

- i. EMD of requisite value and validity.
- ii. Tender fee of requisite value.
- iii. Price Bid as per the Price Schedule mentioned in Annexure I (BOQ)
- iv. Necessary documents against compliance to Qualification Requirements mentioned at Clause 1.7 of this Tender Document.
- v. Filled in Schedule of Deviations as per Annexure III.
- vi. Filled in Schedule of Commercial Specifications as per Annexure IV.
- vii. Signed and filled in Specification and GTP as per Annexure II.
- viii. Duly filled and signed Annexure V and VI.
- ix. Receipt of Bid within the due date and time.

CCG reserves the right to accept/reject any or all the bids without assigning any reason thereof.

CENTRALIZED CONTRACTS GROUP

NIT No.: TPCODL/CCG/23-24/019

1.7 Qualification Criteria

1. The Average Annual Turnover of the prospective bidder(s) should be equal to or more than **Rs. 06 Crores** during any three of last five Financial years (i.e FY 18-19 ,FY 19-20, FY 20-21, FY 21-22 & FY 22-23). For MSME registered in the State of Odisha, criteria shall be reduced to 20% of the existing one. Copy of audited P&L Account (with UDIN no.) to be submitted in this regard.
2. The bidder should have own manufacturing facility to manufacture AB Switches of same or higher rating and should have in-house facilities for routine & acceptance tests as per technical specifications. Bidder must submit undertaking in this regard.
3. Bidder should have Experience of having successfully executed supply orders for at least 50% of tender quantity (cumulative) or single order of 25% of tender quantity or 2 orders of 10% each of same or higher rating during last 5 years.
Copy of work order / completion certificate to be submitted in this regard. Last day of previous month prior to date of bid submission shall be counted for purpose of years calculation.
4. Certificate for 1 year of satisfactory performance of AB Switch of similar or higher rating issued by any Discoms/ PSUs / Reputed companies is to be submitted. The work against these issued certificates should be completed in last 07 years from the date of bid submission. In case the bidder has a previous association with Tata Power Discoms for similar products and services, the performance feedback for that bidder by Tata Power's User Group shall only be considered irrespective of performance certificates issued by any third organization.
5. The bidder must adhere to all statutory compliances like valid PAN no, and GST No. The bidder must submit the copy of all these registrations.

1.8. Marketing Integrity

We have a fair and competitive marketplace. The rules for bidders are outlined in the General Condition of Contracts. Bidders must agree to these rules prior to participating. In addition to other remedies available, CCG reserves the right to exclude a bidder from participating in future markets due to the bidder's violation of any of the rules or obligations contained in the General Condition of Contracts. A bidder who violates the market place rules or engages in behavior that disrupts the fair execution of the marketplace, may result in restriction of a bidder from further participation in the marketplace for a length of time, depending upon the seriousness of the violation. Examples of violations include, but are not limited to:

- Failure to honor prices submitted to the marketplace
- Breach of terms as published in TENDER/NIT

1.9. Supplier Confidentiality

All information contained in this tender is confidential and shall not be disclosed, published or advertised in any manner without written authorization from TPCODL/TPWODL/TPNODL/TPSODL. This includes all bidding information submitted to TPCODL/TPWODL/TPNODL/TPSODL. All tender documents remain the property of TPCODL/TPWODL/TPNODL/TPSODL and all suppliers are required to return these documents to TPCODL upon request. Suppliers who do not honor these confidentiality provisions will be excluded from participating in future bidding events.

TPCODL

TP Central Odisha Distribution Limited

TPNODL

TP Northern Odisha Distribution Limited

TPSODL

TP Southern Odisha Distribution Limited

TPWODL

TP Western Odisha Distribution Limited

CENTRALIZED CONTRACTS GROUP

NIT No.: TPCODL/CCG/23-24/019

2.0 Evaluation Criteria

- The bids will be evaluated technically and on qualifying criteria of tender terms and conditions.
- The bids will be evaluated commercially on **Line-Item basis** (i.e all-inclusive lowest cost for the each line item as calculated in Schedule of Items [Annexure I]).
- Bidder has to mandatorily quote against each item of Schedule of Items [Annexure I]. Failing to do so, TPCODL may reject the bids.

NOTE: In case a new bidder is not registered with TPCODL/TPWODL/TPNODL/TPSODL, factory inspection and evaluation shall be carried out to ascertain bidder's manufacturing capability and quality procedures. However, TPCODL/TPWODL/TPNODL/TPSODL reserves the right to carry out factory inspection and evaluation for any bidder prior to technical qualification.

In case a bidder is found as Disqualified in the factory evaluation, their bid shall not be evaluated any further and shall be summarily rejected. The decision of TPCODL/TPWODL/TPNODL/TPSODL shall be final and binding on the bidder in this regard.

2.1 Price Basis: Price will be fixed and firm during the contractual period.

3.0 Submission of Bid Documents**3.1 Bid Submission**

Bidders are requested to submit their offer in line with this Tender document through e-tendering process.

Please note all future correspondence regarding the tender, bid submission, bid submission date extension, Pre-bid query etc. will happen only through TPCODL E-Tender system (Ariba).

No e-mail or verbal correspondence will be responded. All communication will be done strictly with the bidder who have done the above step to participate in the Tender.

Bids shall be submitted in 3 (Three) parts:

FIRST PART: "EMD" as applicable shall be submitted. The EMD shall be valid for 210 days from the due date of bid submission in the form of Bank Guarantee / Bank Draft / Bankers Pay Order (issued from a Scheduled Bank) online NEFT/ RTGS transfer favoring 'TP Central Odisha Distribution Limited' payable at Bhubaneswar. The EMD BG has to be strictly in the format as mentioned in General Condition of Contract, failing which it shall not be accepted by CCG and the bid as submitted shall be liable for rejection. A separate non-refundable tender fee of stipulated amount also needs to be transferred online through NEFT/ RTGS in case the tender document is downloaded from our website.

TPCODL Bank Details for transferring Tender Fee and EMD is as below:

Account Name: TP CENTRAL ODISHA DISTRIBUTION LIMITED

Bank Name: SBI, IDCO Towers, Bhubaneswar

Bank Account No.: 10835304915

IFSC Code: SBIN007891

Note- EMD is preferred in form of Bank Guarantee and to be delivered at the following address. However, in view of present situation if Bidder is finding it difficult to make and submit BG for EMD amount, they can do

TPCODL

TP Central Odisha Distribution Limited

TPNODL

TP Northern Odisha Distribution Limited

TPSODL

TP Southern Odisha Distribution Limited

TPWODL

TP Western Odisha Distribution Limited

CENTRALIZED CONTRACTS GROUP

NIT No.: TPCODL/CCG/23-24/019

online transfer of EMD amount in the above mentioned Account and submit proof of the same as part of Bid Submission.

Please note that in such case, Tender Fee and EMD should be strictly 2 separate transactions.

Please note as return of EMD from Bank Account is non-standard practice and the same may take more time than return of EMD BG.

EMD Original Hard Copy shall be delivered at the following address in Envelope clearly indicating Tender Reference/ Enquiry Number, Name of Tender and Bidder Name

**Chief –Centralized Contracts Group
TP Central Odisha Distribution Limited
1st Floor, Anuj Building, Plot No. 29, Satya Nagar, Bhubaneswar- 751007**

EMD shall be exempted for MSME registered in the State of Odisha. However, Bidder shall be barred to participate in the tendering process for a period of 2 years in case it backs out post award of the contract.

SECOND PART: “TECHNICAL BID” shall contain the following documents:

- i) Requisite Documents for compliance to Qualification Criteria mentioned in Clause 1.7 and clause no. 1.4.
- ii) Type Test Certificate of Lightning Arrester of same or higher rating.
- iii) Acceptance of Specification as per Annexure II.
- iv) Duly signed and stamped ‘Schedule of Deviations’ as per Annexure III on bidder’s letter head.
- iv) Duly signed and stamped ‘Schedule of Commercial Specifications’ as per Annexure IV on bidder’s letter head.
- v) Duly filled in Annexure V and VI.
- vi) Proper authorization letter/ Power of Attorney to sign the tender on the behalf of bidder.
- vii) Copy of PAN, GST registration (In case any of these documents is not available with the bidder, same to be explicitly mentioned in the ‘Schedule of Deviations’)

The technical bid shall be properly indexed and is to be submitted through CCG/TPCODL E-tender System (Ariba) only. Hard Copy of Technical Bids need not be submitted

THIRD PART: “PRICE BID” shall contain only the price details and strictly in format as mentioned in Annexure I along with explicit break up of basic prices and Taxes & duties etc. In case any discrepancy is observed between the item description stated in Schedule of Items mentioned in the tender and the price bid submitted by the bidder, the item description as mentioned in the tender document (to the extent modified through Corrigendum issued if any) shall prevail.

Price Bid is to be submitted in soft copy through CCG/TPCODL E-Tendering system (Ariba) only. Hard copy of Price Bid not be submitted

The EMD in the form of Bank Draft / BG / Bankers Pay Order shall be submitted in original hard copy and then placed in sealed envelope which shall be clearly marked as below:

EMD

“RC for supply of AB Switches of various ratings for TPCODL/TPWODL/TPNODL/TPSODL”

The Bid prepared by the Bidder, and all correspondence and documents relating to the Bid exchanged by the Bidder and the TPCODL, shall be written in the English Language. Any printed literature furnished by the

TPCODL

TP Central Odisha Distribution Limited

TPNODL

TP Northern Odisha Distribution Limited

TPSODL

TP Southern Odisha Distribution Limited

TPWODL

TP Western Odisha Distribution Limited

CENTRALIZED CONTRACTS GROUP**NIT No.: TPCODL/CCG/23-24/019**

Bidder may be written in another Language, provided that this literature is accompanied by an English translation, in which case, for purposes of interpretation of the Bid, the English translation shall govern.

SIGNING OF BID DOCUMENTS:

The bid must contain the name, residence and place of business of the person or persons making the bid and must be signed and sealed by the Bidder with his usual signature. The names of all persons signing should also be typed or printed below the signature.

The Bid being submitted must be signed by a person holding a Power of Attorney authorizing him to do so, certified copies of which shall be enclosed.

The Bid submitted on behalf of companies registered with the Indian Companies Act, for the time being in force, shall be signed by persons duly authorized to submit the Bid on behalf of the Company and shall be accompanied by certified true copies of the resolutions, extracts of Articles of Association, special or general Power of Attorney etc. to show clearly the title, authority and designation of persons signing the Bid on behalf of the Company. Satisfactory evidence of authority of the person signing on behalf of the Bidder shall be furnished with bid.

A bid by a person who affixes to his signature the word 'President', 'Managing Director', 'Secretary', 'Agent' or other designation without disclosing his principal will be rejected.

The Bidder's name stated on the Proposal shall be the exact legal name of the firm.

3.2 Contact Information

All the bidders are requested to send their pre-bid queries (if any) against this tender through e-mail within the stipulated timelines. The consolidated reply to all the queries received shall be posted on TPCODL website by the stipulated timelines as detailed in calendar of events.

Communication Details:**Handling Executive for this Tender:**

Name: Santanu Mukherjee
Contact No.: 6297445379
E-Mail ID: santanu.mukherjee@tpnodl.com

Escalation:Head -CCG:

Name: Mr. Vipin Chauhan
Contact No.: 9717393121
E-Mail ID: Vipin.Chauhan@tpnodl.com

3.3 Bid Prices

Bidders need to quote for all items as per the Price schedule attached in Annexure I. The bidder shall complete the appropriate Price Schedules included herein, stating the Unit Price for each item & total price with taxes, duties & freight up to destination at various sites of TPCODL/TPWODL/TPNODL/TPSODL. The all-inclusive prices offered shall be inclusive of all costs as well as Duties, Taxes and Levies paid or payable during the execution of the supply work, breakup of price constituents.

Applicable GST to be specified clearly.

CENTRALIZED CONTRACTS GROUP

NIT No.: TPCODL/CCG/23-24/019

The quantity break up shown else-where other than Price Schedule is tentative. The bidder shall ascertain himself regarding material required for completeness of the entire work. Any items not indicated in the price schedule but which are required to complete the job as per the Technical Specifications/ Scope of Work/ SLA mentioned in the tender, shall be deemed to be included in prices quoted.

3.4 Bid Currencies

Prices shall be quoted in Indian Rupees Only.

3.5 Period of Validity of Bids

Bids shall remain valid for 180 days from the due date of submission of the bid.

Notwithstanding clause above, the TPCODL/TPWODL/TPNODL/TPSODL may solicit the Bidder's consent to an extension of the Period of Bid Validity. The request and responses thereto shall be made in writing.

3.6 Alternative Bids

Bidders shall submit Bids, which comply with the Bidding documents. Alternative bids will not be considered. The attention of Bidders is drawn to the provisions regarding the rejection of Bids in the terms and conditions, which are not substantially responsive to the requirements of the bidding documents.

3.7 Modifications and Withdrawal of Bids

The bidder is not allowed to modify or withdraw its bid after the Bid's submission. The EMD as submitted along with the bid shall be liable for forfeiture in such event.

3.8 Earnest Money Deposit (EMD)

The bidder shall furnish, as part of its bid, an EMD amounting as specified in the tender. The EMD is required to protect TPCODL against the risk of bidder's conduct which would warrant forfeiture.

The EMD shall be denominated in any of the following form:

- Banker's Cheque/ Demand Draft/ Pay order drawn in favor of TP Central Odisha Distribution Limited payable at Bhubaneswar.
- Online transfer of requisite amount through NEFT/ RTGS.
- Bank Guarantee valid for 210 days after due date of submission.

The EMD shall be forfeited in case:

a) The bidder withdraws its bid during the period of specified bid validity.

Or

b) The successful Bidder does not

- a) accept the Purchase Order, or
- b) furnish the required Performance Security Bank Guarantee

3.9 Type Tests (if applicable)

The type tests specified in TPCODL/TPNODL/TPSODL/TPWODL specifications should have been carried out within five years prior to the date of opening of technical bids and test reports are to be submitted along with the bids. If type tests carried out are not within the five years prior to the date of bidding, the bidder will arrange to carry out type tests specified, at his cost. The decision to accept/ reject such bids rests with TPCODL

TPCODL

TP Central Odisha Distribution Limited

TPNODL

TP Northern Odisha Distribution Limited

TPSODL

TP Southern Odisha Distribution Limited

TPWODL

TP Western Odisha Distribution Limited

CENTRALIZED CONTRACTS GROUP

NIT No.: TPCODL/CCG/23-24/019

4 Bid Opening & Evaluation process**4.1. Process to be confidential**

Information relating to the examination, clarification, evaluation and comparison of Bids and recommendations for the award of a contract shall not be disclosed to Bidders or any other persons not officially concerned with such process. Any effort by a Bidder to influence the TPCODL/TPWODL/TPNODL/TPSODL processing of Bids or award decisions may result in rejection of the Bidder's Bid.

4.2. Technical Bid Opening

Bids will be opened at CCG/TPCODL Office, Bhubaneswar. All tender bids shall be opened internally by TPCODL. Presence of any bidder will not be allowed during bid opening process. Technical bid must not contain any cost information whatsoever.

First the envelope marked "EMD" will be opened. Bids without EMD/cost of tender (if applicable) of required amount/ validity in prescribed format, shall be rejected.

Next, the technical bid of the bidders who have furnished the requisite EMD will be opened, one by one.

4.3. Preliminary Examination of Bids/Responsiveness

TPCODL will examine the Bids to determine whether they are complete, whether any computational errors have been made, whether required sureties have been furnished, whether the documents have been properly signed, and whether the Bids are generally in order. CCG may ask for submission of original documents in order to verify the documents submitted in support of qualification criteria.

Arithmetical errors will be rectified on the following basis: If there is a discrepancy between the unit price and the total price per item that is obtained by multiplying the unit price and quantity, the unit price shall prevail and the total price per item will be corrected. If there is a discrepancy between the Total Amount and the sum of the total price per item, the sum of the total price per item shall prevail and the Total Amount will be corrected.

Prior to the detailed evaluation, CCG will determine the substantial responsiveness of each Bid to the Bidding Documents including production capability and acceptable quality of the Goods offered. A substantially responsive Bid is one, which conforms to all the terms and conditions of the Bidding Documents without material deviation.

Bid determined as not substantially responsive will be rejected by the TPCODL/TPWODL/TPNODL/TPSODL and may not subsequently be made responsive by the Bidder by correction of the non-conformity.

4.4. Techno Commercial Clarifications

Bidders need to ensure that the bids submitted by them are complete in all respects. To assist in the examination, evaluation and comparison of Bids, TPCODL/TPWODL/TPNODL/TPSODL may, at its discretion, ask the Bidder for a clarification on its Bid for any deviations with respect to the TPCODL/TPWODL/TPNODL/TPSODL specifications and attempt will be made to bring all bids on a common footing. All responses to requests for clarification shall be in writing and no change in the price or substance of the Bid shall be sought, offered or permitted owing to any clarifications sought by TPCODL/TPWODL/TPNODL/TPSODL.

CENTRALIZED CONTRACTS GROUP

NIT No.: TPCODL/CCG/23-24/019

4.5. Price Bid Opening

Price bids will be opened internally without the presence of any bidder representative. The EMD of the bidder withdrawing or substantially altering his offer at any stage after the technical bid opening will be forfeited at the sole discretion of TPCODL/TPWODL/TPNODL/TPSODL without any further correspondence in this regard.

4.6. Reverse Auctions

TPCODL/TPWODL/TPNODL/TPSODL reserves the right to conduct the reverse auction (instead of public opening of price bids) for the products/ services being asked for in the tender. The terms and conditions for such reverse auction events shall be as per the Acceptance Form attached as Annexure VI of this document. The bidders along with the tender document shall mandatorily submit a duly signed copy of the Acceptance Form attached as Annexure VI as a token of acceptance for the same.

5 Award Decision

TPCODL/TPWODL/TPNODL/TPSODL will award the contract to the successful bidder whose bid has been determined to be the lowest-evaluated responsive bid as per the Evaluation Criterion mentioned at Clause 2.0. The Cost for the said calculation shall be taken as the all-inclusive cost quoted by bidder in Annexure I (Schedule of Items) subject to any corrections required in line with Clause 3.1 above. The decision to place purchase order/LOI solely depends on CCG on the cost competitiveness across multiple lots, quality, delivery and bidder's capacity, in addition to other factors that CCG may deem relevant.

TPCODL/TPWODL/TPNODL/TPSODL reserves the rights to award contract to one or more bidders so as to meet the delivery requirement or nullify award decision without assigning any reason thereof.

In case any supplier is found unsatisfactory during delivery process, the award will be cancelled and TPCODL/TPWODL/TPNODL/TPSODL reserves right to award contract to other suppliers who are found fit.

6 Order of Preference/Contradiction

In case of contradiction in any part of various documents in tender, following shall prevail in order of preference:

1. Schedule of Items (Annexure I)
2. Technical Specifications (Annexure II)
3. Special Conditions of Contract (Clause 7.0)
4. Submission of Bid Documents (Clause 3.0)
5. Acceptance Form for Participation in Reverse Auction (Annexure VI)
6. General Conditions of Contract (Annexure VIII)

CENTRALIZED CONTRACTS GROUP

NIT No.: TPCODL/CCG/23-24/019

7 Post Award Contract Administration**7.1. Special Conditions of Contract**

1. Rate Contract shall be valid for a period of 12 months from the placement of the Contract. Release Order (RO) shall be placed as per the requirement of respective TP Odisha Discom. Rates shall remain firm throughout RC period.
2. Prices shall be inclusive of Transit Insurance/ Packing & Forwarding charges and shall be inclusive of unloading and stacking at TPNODL, TPWODL, TPSODL & TPCODL site/store locations.
3. BA shall submit applicable PBG as per GCC within 21 days of issuance of RC. PBG applicable shall be 5% of contract value. PBG submitted, shall be released after completion of applicable guarantee period plus one month. Performance Bank Guarantee for MSME registered in the State of Odisha shall be 25% of the value normally prescribed.
4. Guarantee period shall be 24 months from date of supply.
5. BA shall submit GTP/ Drawing within 10 days from issuance of rate contract. In case BA does not get necessary approvals for issuance of manufacturing clearances /CAT-A within mentioned /mutually agreed timelines, then CCG-TPCODL/other TP Odisha Discoms reserve the right to cancel issued rate contract / release order and also reserve the right to forfeit EMD/PBG.
6. Delivery Period shall be 90 days from date of receipt of release order / CAT-A issuance, whichever is later.
7. Payment Terms: 100% payment within 60 days of submission of error-free Invoice complete in all respects. However, for MSME the payment cycle shall be 45 days.
8. Prices shall remain firm throughout the RC period.
9. Pre-dispatch inspection, MDCC and LD shall be applicable as per GCC.
10. CCG-TPCODL / Other TP Odisha Discoms shall short close the issued Release Order / Rate contract, in case of any quality issues.
11. Any change in statutory taxes, duties and levies during the contract period shall be borne by respective TP Odisha Discom. However, in case of delay in supply owing to reasons not attributable to TP Odisha Discom, any increase in total liability shall be passed on the Bidder, whereas any benefits arising owing to such statutory variation in taxes and duties shall be passed on TP Odisha Discom.
12. All other terms of GCC – Supply shall be applicable.

7.2 Drawing Submission and Approval

As per SCC, Clause number 7.1.

7.3 Payment Terms

As per SCC, Clause number 7.1.

TPCODL

TP Central Odisha Distribution Limited

TPNODL

TP Northern Odisha Distribution Limited

TPSODL

TP Southern Odisha Distribution Limited

TPWODL

TP Western Odisha Distribution Limited

CENTRALIZED CONTRACTS GROUP

NIT No.: TPCODL/CCG/23-24/019

7.4 Climate Change

Significant quantities of waste are generated during the execution of project and an integrated approach for effective handling, storage, transportation and disposal of the same shall be adopted. This would ensure the minimization of environmental and social impact in order to combat the climate change. Please refer attached Environment Policy and Sustainability Policy, enclosed for more details.

7.5 Ethics

TPCODL/TPSODL/TPNODL/TPWODL is an ethical organization and as a policy TPCODL/TPSODL/TPNODL/TPWODL lays emphasis on ethical practices across its entire domain. Bidder should ensure that they should abide by all the ethical norms and in no form either directly or indirectly be involved in unethical practice.

TPCODL work practices are governed by the Tata Code of Conduct which emphasizes on the following:

- We shall select our suppliers and service providers fairly and transparently.
- We seek to work with suppliers and service providers who can demonstrate that they share similar values. We expect them to adopt ethical standards comparable to our own.
- Our suppliers and service providers shall represent our company only with duly authorized written permission from our company. They are expected to abide by the Code in their interactions with, and on behalf of us, including respecting the confidentiality of information shared with them.
- We shall ensure that any gifts or hospitality received from, or given to, our suppliers or service providers comply with our company's gifts and hospitality policy.
- We respect our obligations on the use of third party intellectual property and data.

Bidder is advised to refer Tata Code of Conduct (TCOC) attached for more information.

Any ethical concerns with respect to this tender can be reported to the following e-mail ID:

pradip.sil@tpcentralodisha.com

8 Specification and standards

As per Annexure II

9 General Condition of Contract

Any condition not mentioned above shall be applicable as per GCC attached along with this tender.

TPCODL

TP Central Odisha Distribution Limited

TPNODL

TP Northern Odisha Distribution Limited

TPSODL

TP Southern Odisha Distribution Limited

TPWODL

TP Western Odisha Distribution Limited

CENTRALIZED CONTRACTS GROUP

NIT No.: TPCODL/CCG/23-24/019

Annexure-I, Price Schedule

S. No.	Item Description	Qty.	Unit	HSN /SAC Code	Unit Ex-Work Price (Rs./Unit)	Freight (Rs./Unit)	GST (Rs/Unit)	All Inclusive Unit Rate (Rs.)	Total All Inclusive Value (Rs.)
1	2	3	4	5	6	7	8	9=(6+7+8)	10=(3x9)
1	AB S/W 11KV 200A 3 POLE HORIZONTAL	23,241							
2	AB S/W 33KV 400A 3 POLE GANG OPE. HORIZONTAL	2,490							
3	AB S/W 11KV 400A 3 POLE HORIZONTAL	9,340							
GRAND TOTAL AMOUNT (Rs.)									

NOTE:

- Prices shall be firm till the validity of the contract.
- The bids will be evaluated commercially on the **line-item wise** lowest cost basis.
- The unit price to be entered in column "6" of above table is exclusive of GST.
- The prices mentioned above shall be on FOR basis for all the TPNODL, TPCODL, TPWODL & TPSODL locations.
- Issuance of Release Orders (RO) shall be done by respective discoms as per their requirement.
- The material shall be delivered as per the location captured in the release order.
- The bidders are advised to quote prices strictly in the above format. Failing to do so, bids are liable for rejection.
- The bidder must fill each and every column of the above format. **Mentioning "extra/inclusive" in any of the column may lead for rejection of the price bid.**
- No cutting/ overwriting in the prices is permissible.
- The quantity mentioned above are for evaluation purpose only and may vary as per actual site requirement.

TPCODL

TP Central Odisha Distribution Limited

TPNODL

TP Northern Odisha Distribution Limited

TPSODL

TP Southern Odisha Distribution Limited

TPWODL

TP Western Odisha Distribution Limited

CENTRALIZED CONTRACTS GROUP

NIT No.: TPCODL/CCG/23-24/019

CONFIDENTIAL

Annexure-II, Technical Specification

(Attached separately with Tender)

CENTRALIZED CONTRACTS GROUP

NIT No.: TPCODL/CCG/23-24/019

ANNEXURE III**Schedule of Deviations**

*Bidders are advised to refrain from taking any deviations on this TENDER. Still in case of any deviations, all such deviations from this tender document shall be set out by the Bidders, Clause by Clause in this schedule and submit the same as a part of the **Technical Bid**.*

*Unless **specifically** mentioned in this schedule, the tender shall be deemed to confirm the TPCODL/TPWODL/TPNODL/TPSODL's specifications:*

S. No.	Clause No.	Tender Clause Details	Details of deviation with justifications

By signing this document we hereby withdraw all the deviations whatsoever taken anywhere in this bid document and comply to all the terms and conditions, technical specifications, scope of work etc. as mentioned in the standard document except those as mentioned above.

Seal of the Bidder:

Signature:

Name:

CENTRALIZED CONTRACTS GROUP

NIT No.: TPCODL/CCG/23-24/019

ANNEXURE IV**Schedule of Commercial Specifications**

(The bidders shall mandatorily fill in this schedule and enclose it with the offer Part I: Technical Bid. In the absence of all these details, the offer may not be acceptable.)

S. No.	Particulars	Remarks
1.	Prices firm or subject to variation (If variable indicate the price variation clause with the ceiling if applicable)	Firm / Variable
1a.	If variable price variation on clause given	Yes / No
1b.	Ceiling	----- %
1c.	Inclusive of GST	Yes / No (If Yes, indicate % rate)
1d.	Inclusive of transit insurance	Yes / No
2.	Delivery	Weeks / months
3.	Guarantee clause acceptable	Yes / No
4.	Terms of payment acceptable	Yes / No
5.	Performance Bank Guarantee acceptable	Yes / No
6.	Liquidated damages clause acceptable	Yes / No
7.	Validity (180 days) (From the date of opening of bid)	Yes / No
8.	Inspection during stage of manufacture	Yes / No
9.	Rebate for increased quantity	Yes / No (If Yes, indicate value)
10.	Change in price for reduced quantity	Yes / No (If Yes, indicate value)
11.	Covered under Small Scale and Ancillary Industrial Undertaking Act 1992	Yes / No (If Yes, indicate, SSI Reg'n No.)

Seal of the Bidder:**Signature:****Name:**

CENTRALIZED CONTRACTS GROUP

NIT No.: TPCODL/CCG/23-24/019

ANNEXURE V**Checklist of all the documents to be submitted with the Bid**

Bidder has to mandatorily fill in the checklist mentioned below:

S. No.	Documents attached	Yes / No / Not Applicable
1	EMD of required value	
2	Tender Fee as mentioned in this tender	
3	Signed copy of this tender as an unconditional acceptance	
5	Duly filled schedule of commercial specifications (Annexure IV)	
6	Sheet of commercial/technical deviation if any (Annexure III)	
7	Balance sheet for the last completed three financial years; mandatorily enclosing Profit & loss account statement	
8	Acknowledgement for Testing facilities if available (duly mentioned on bidder letter head)	
9	List of Machine/tools with updated calibration certificates if applicable	
10	Details of order copy (duly mentioned on bidder letter head)	
11	Order copies as a proof of quantity executed	
12	Details of Type Tests if applicable (duly mentioned on bidder letter head)	
13	All the relevant Type test certificates as per relevant IS/IEC (CPRI/ERDA/other certified agency) if applicable	
14	Project/supply Completion certificates	
15	Performance certificates	
16	Client Testimonial/Performance Certificates	
17	Credit rating/solvency certificate	
18	Undertaking regarding non blacklisting (On company letter head)	
19	List of trained/untrained Manpower	

Seal of the Bidder:**Signature:****Name**

TPCODL

TP Central Odisha Distribution Limited

TPNODL

TP Northern Odisha Distribution Limited

TPSODL

TP Southern Odisha Distribution Limited

TPWODL

TP Western Odisha Distribution Limited

CENTRALIZED CONTRACTS GROUP

NIT No.: TPCODL/CCG/23-24/019

ANNEXURE VI**ACCEPTANCE FORM FOR PARTICIPATION IN REVERSE AUCTION EVENT*****(To be signed and stamped by the bidder)***

In a bid to make our entire procurement process more fair and transparent, TPCODL intends to use the reverse auctions as an integral part of the entire tendering process. All the bidders who are found as technically qualified based on the tender requirements shall be eligible to participate in the reverse auction event.

The following terms and conditions are deemed as accepted by the bidder on participation in the bid event:

1. TPCODL/TPWODL/TPNODL/TPSODL shall provide the user id and password to the authorized representative of the bidder. *(Authorization Letter in lieu of the same shall be submitted along with the signed and stamped Acceptance Form).*
2. TPCODL/TPWODL/TPNODL/TPSODL will make every effort to make the bid process transparent. However, the award decision by TPCODL/TPWODL/TPNODL/TPSODL would be final and binding on the supplier.
3. The bidder agrees to non-disclosure of trade information regarding the purchase, identity of TPCODL/TPWODL/TPNODL/TPSODL, bid process, bid technology, bid documentation and bid details.
4. The bidder is advised to understand the auto bid process to safeguard themselves against any possibility of non-participation in the auction event.
5. In case of bidding through Internet medium, bidders are further advised to ensure availability of the entire infrastructure as required at their end to participate in the auction event. Inability to bid due to telephone line glitch, internet response issues, software or hardware hangs, power failure or any other reason shall not be the responsibility of TPCODL/TPWODL/TPNODL/TPSODL.
6. In case of intranet medium, TPCODL/TPWODL/TPNODL/TPSODL shall provide the infrastructure to bidders. Further, TPCODL/TPWODL/TPNODL/TPSODL has sole discretion to extend or restart the auction event in case of any glitches in infrastructure observed which has restricted the bidders to submit the bids to ensure fair & transparent competitive bidding. In case of an auction event is restarted, the best bid as already available in the system shall become the start price for the new auction.
7. In case the bidder fails to participate in the auction event due any reason whatsoever, it shall be presumed that the bidder has no further discounts to offer and the initial bid as submitted by the bidder as a part of the tender shall be considered as the bidder's final no regret offer. Any offline price bids received from a bidder in lieu of non-participation in the auction event shall be out-rightly rejected by TPCODL/TPWODL/TPNODL/TPSODL.
8. The bidder shall be prepared with competitive price quotes on the day of the bidding event.
9. The prices as quoted by the bidder during the auction event shall be inclusive of all the applicable taxes, duties and levies and shall be FOR at TPCODL/TPSODL/TPNODL/TPWODL site.
10. The prices submitted by a bidder during the auction event shall be binding on the bidder.
11. No requests for time extension of auction event shall be considered by TPCODL/TPWODL/TPNODL/TPSODL.
12. The original price bids of the bidders shall be reduced on pro-rata basis against each line item based on the final all-inclusive prices offered during conclusion of the auction event for arriving at Contract amount.

[Signature & Stamp of Bidder]

STANDARD TECHNICAL SPECIFICATION COVER SHEET

Specification No. : ENG-EHV-1018

Specification Name : Technical Specification for 33 kV AB switch (400 A)

YASHOBANTA ROUT	ANUP SAMAL	J DURAIRAJ	Sandeep Saurav	KHAJAN BHARDWAJ	POURUSH GARG
Prepared by	Reviewed by	Reviewed by	Reviewed by	Approved by	Released by
TPCODL	TPNODL	TPWODL	TPSODL	TPCODL	TPCODL
10-01-2023	10-01-2023	10-01-2023	10-01-2023	10-01-2023	12-01-2023

*Property of TATA POWER ODISHA DISCOMs – Not to be reproduced without permission of TPCODL/ TPNODL/ TPSODL/
TPWODL*

CONTENTS

1. SCOPE
2. APPLICABLE STANDARDS
3. CLIMATIC CONDITIONS OF THE INSTALLATION
4. GENERAL TECHNICAL REQUIREMENTS
5. GENERAL CONSTRUCTIONS/REQUIREMENTS
6. MARKING
7. TESTS
8. TYPE TEST CERTIFICATES
9. PRE-DISPATCH INSPECTION
10. INSPECTION AFTER RECEIPT AT STORES
11. GUARANTEE
12. PACKING
13. TENDER SAMPLE
14. QUALITY CONTROL
15. MINIMUM TESTING FACILITIES
16. MANUFACTURING ACTIVITIES
17. SPARES, ACCESSORIES AND TOOLS
18. DRAWINGS AND DOCUMENTS
19. GUARANTEED TECHNICAL PARTICULARS
20. SCHEDULE OF DEVIATIONS

1. SCOPE

This specification covers design, manufacturing, testing at manufacturer's works, inspection, packing & delivery of 33 kV Air Break Switch with accessories for out-door installation for use on transformer centers and tap line in Central Odisha. Aforesaid item(s) shall include loading and unloading at anywhere in Odisha.

It is not the intent to specify completely herein all the details of design and construction of Air Break Switches. However, AB Switches will confirm in all respects to high standards of engineering design and workmanship and shall be capable of performing in continuous Commercial operation up to the supplier's guarantee, in a manner acceptable to the purchaser, who will interpret the meanings of drawings and specifications and shall have the power to reject any material, which in his judgment i.e. not in accordance with the specifications/drawings.

The AB Switches offered shall be complete with all components necessary for its effective and trouble-free operation along with associated equipment etc. such components shall be deemed to be within the scope of supplier's supply, irrespective of whether those are specifically brought out in the specification and/or in order or not. Also similar parts particularly removable ones shall be inter-changeable.

2. APPLICABLE STANDARDS

The equipment covered by this specification shall unless otherwise stated, be designed, manufactured and tested in accordance with the latest editions of the following Indian, International Standards and shall conform to the regulations of the local authorities:

Ref. IS	Description
IS 9920 (part-I to V)	Specification for helically formed fittings for Overhead lines up to 33 kV
IS 2633 (Part 1)	Method for testing uniformity of coating on zinc coated
IEC 62231	Composite station post insulators for substations with a.c. voltages greater than 1 000 V up to 245 kV – Definitions, test methods and acceptance criteria
IEC 60168:1994+AMD1:1997+AMD2:2000 CSV	Tests on indoor and outdoor post insulators of ceramic material or glass for systems with nominal voltages greater than 1000 V
IS 9530	Recommended practice for silver plating
IS 5925	Recommended practice for silver plating for general engineering purposes
BS 2816	Testing of silver plating thickness

IS 1239	GI pipe('B' class or Medium class)
IS: 5561	Electrical Power Connectors
IS 2062	Hot rolled medium and high tensile structural steel — specification

3. CLIMATIC CONDITIONS OF THE INSTALLATION

SL.NO.	CONDITONS	VALUES
1	Max. altitude above sea level	1200m
2	Max. Ambient Temperature	50 °C
3	Max. Daily average ambient temp	35 °C
4	Min Ambient Temp	0 °C
5	Maximum temperature attainable by an object exposed to sun	60 °C
6	Maximum Humidity	95%
7	Minimum Humidity	10%
8	Average No. of thunderstorm days per annum	70
9	Average Annual Rainfall	150 cm
10	Average No. of rainy days per annum	120
11	Thermal Resistivity of soil	150 Deg. Ccm/W
12	Wind Pressure	126 kg/sq. m up to an elevation of 10 meter.
14	Earthquakes of intensity in horizontal direction	equivalent to seismic acceleration of 0.3g
15	Earthquakes of intensity in vertical direction	equivalent to seismic acceleration of 0.15g
16	Wind velocity	300 km/hr.

TPCODL/TPNODL/TPSODL/TPWODL service area has heavy saline conditions along the coast and High cyclonic Intensity winds with speed upto 300 Kmph. The atmosphere is generally laden with mild acid and dust in suspension during the dry months and is subjected to fog in cold months.

4. GENERAL TECHNICAL REQUIREMENTS

SL. NO.	TECHNICAL PARTICULARS	DESIRED VALUE
1	Rating of AB Switch	400 Amps AB Switch
1.a	Reference standards (latest amend.)	IS 9920, IEC 129, IEC 62231,IS 1239
2	Installation	Outdoor

SL. NO.	TECHNICAL PARTICULARS	DESIRED VALUE
3	Suitable for Mounting	Horizontal Rotating Type
4	Type	3 Pole
5	Service Voltage	33 kV
6	Rated Voltage	36 kV
7	Rated Frequency	50 Hz
8	Current Carrying Capacity	400 Amps
9	Rated short time current	16 kA for 1sec
10	Rated peak withstand current	40 kA
11	Rated Short circuit making capacity	25 KA RMS
12	Rated Cable Charging breaking capacity	40 A RMS
13	Rated line charging breaking capacity	5.3 A RMS
14	Rated Transformer off load breaking Capacity	16 A RMS
15	One-minute power frequency withstand voltage Dry	95 KV RMS
16	One-minute power frequency withstand voltage Wet	75 KV RMS
17	Power Frequency puncture withstand voltage	1.3 times of actual dry flashover voltage
A	Visible Discharge Voltage	27 KV RMS
B	Dry flashover Voltage	95 kV
18	Power Frequency withstand voltage between pole and earth	70 KV RMS
19	Power frequency withstand voltage across the isolation distance	80 KV RMS
20	Impulse withstand voltage for positive and negative polarity (1.2 / 50) micro second wave)	
A	Across Isolating distance	195 KV Peak
B	To earth and between poles	170 KV Peak
21	No. of Post Per Phase (Polymeric, IEC 62231)	02
22	Total No. of post	06
22.a	FRP Dia of the Post Insulator (min)	32mm
22.b	Dai of Weather sheds	>100mm
22.c	Thickness of Housing (min)	3mm
22.d	Type of Sheds	Aerodynamic
23	Minimum Creepage Distance	900 mm (one post)
24	Phase to Phase Clearance	1200 mm
25	Isolation Distance in switch open condition	640 mm
26	Vertical clearance from Top of Insulator cap to mounting channel	508 mm (Minimum)
27	Copper contacts Temp in Air should not exceed	65 Degree

SL. NO.	TECHNICAL PARTICULARS	DESIRED VALUE
28	Size of fixed contacts (Copper Type Electrolytic with silver plated) (coating thickness not less than 10 microns)	80mmx50mmx8mm Jaw assemblies are to be bolted through stainless steel flat and spring washer (Min 6 nos. of phosphor bronze high pressure spring to be used on each post).
29	Size of Moving contacts (Copper Type Electrolytic with silver plated) (coating thickness not less than 10 microns)	250mmx50mmx8mm (a Min deposit of 10 micron of Silver on copper contact)
30	Moving Contact supporting Angle	50mmx50mmx6mm
31	Size of rods used for arcing horns	10 mm
32	Insulation for tinned Copper braid/rope	Polyolefin, (RSFR-H) type
33	Copper Flexible BRAIDED Tape - 420 mm Long, Tined plated with Brass Nut, bolt & Washers both end shall be crimped with copper socket through brass bolts and nuts	450gm /Mtr
34	Minimum size*Length of Coupling Hot Dip GI Solid Pipe for Phase coupling pipe, B Class (IS 1239)(Nominal Bore)	25mm Dia & 2500mm long
35	Operating Down Pipe, B Class (IS 1239)(Nominal Bore)	32mm Dia & 7 Mtr Long (one piece)
36	Temperature Rise Limit (w.r.t ambient temp) - Tinned Copper contacts - Terminals - Metal Parts	50°C 40°C 40°C
37	Arching Horns	10 mm dia GI rod
38	Locking Arrangement	Provision for pad locking at both 'ON' & 'OFF' position
39	Earth Terminal	M12 Bolts with nuts and flat washer shall be provided at base channel as earthing Terminal.
40	'T' Connection	The T connection provided on the channel having 'moving contact' shall be G.I Nut & bolt at the bottom end to facilitate replacement of this unit only during requirements & avoid entire change of arm.
41	'I' bolt	The I bolt shall be longer with 75 mm thread.
42	Supporting Channel HDG 100 micron	100x50x6 mm hot dip galvanized channel (C/C slotted 18x36 hole 250 mm) Min. 760 mm length
43	Connectors/sockets	Connectors shall be of hard drawn electrolytic copper or brass. The connector should be of 4 bolted type and suitable for 100-232 sqmm AAC conductor. SOCKET: Two no. of bimetallic copper sockets shall be used at both ends suitable for 100-232 sqmm AAC conductor.

SL. NO.	TECHNICAL PARTICULARS	DESIRED VALUE
44	Terminal Connectors/ Pads	The size of fixed connector shall be (80 x 50 x 8) and size of movable connector shall be (80 x50)x (80 x 50) x 8 mm of HDE copper with uniform machine finishing duly silver plated with 2 no. of 14 mm dia holes provided with suitable brass bolts, double nuts, washers & spring washers
45	Bearing	4 nos. self-lubricating bearing to be provided with grease nipple including 4 th bearing being a thrust bearing.
46	Marking/Engraving (Parameters should be embossed on SS sheet of thickness 1mm with black background. It should be riveted on MS channel of AB switch)	1. Rated Voltage 2. Manufacturer Name 3. Month/Year of Manufacture 4. Serial No. 5. PO No. 6. Rated Normal Current in Amps 7. Rated One Second Short-Time Current
47	Pressure Spring	Stainless steel

5. GENERAL CONSTRUCTIONS/REQUIREMENTS

- The Air break switch shall be outdoor type, rotating type gang operated and shall be suitable for horizontal installation having 2 no. of polymeric post insulators per phase.
- The Rotating type operating mechanism shall be suitable for manual operation from ground level and shall be designed in such way that all the three phases shall open and close simultaneously in smooth way.
- The air break switch shall be with the arcing horns, 10mm for 33 kV 400 A AB switch of GI rod.
- The current carrying connectors should be two-bolt type having nuts and bolts, with spring washer and plane washer.
- Each joint shall be provided with one plane and one spring of not less than 2mm thickness.
- Connectors shall be of H D electrolytic copper or Brass.
- Tinned Copper braid/rope shall be insulated by Polyolefin (RSFR-H) type to prevent animal electrocution. It shall be 420 mm long minimum and shall weigh 450 G/M. It shall be punched at both ends.
- All ferrous parts shall be hot dip galvanized with heavy coating after proper surface treatment as per standards. Coating thickness shall not be less than 100 micron at any point.
- All Copper parts shall be silver plated as per relevant standards and coating thickness not less than 10 microns at any point.
- Equipment grounding shall be provided by bidder at two points with terminals. .
- All the nut bolt used must be Hot dip Galvanized and of size not less than M10 until and unless specified.
- A rigid base of galvanized steel channel of size approx.100x50x6 mm Length 760 mm min. (C/C slotted hole 18x 36 mm- 250mm shall be provided with clamps and bolts for Horizontal mounting firmly on steel structure.
- Each member of the switch shall be free from Rust, sharp edges, burr and any kind of deformation.

14. The phase coupling rod, operation rod with intermediate guide braided with flexible electrolytic copper, tail piece of required current carrying capacity and operation mechanism with 'ON' & 'OFF' positions shall be provided.
15. The operation rod shall be medium gage of 32mm diameter nominal bore G.I. pipe single length 7 meters. The phase coupling rod for gang operation shall be of medium gauge 25mm dia & 2500 mm length nominal bore G.I. pipe.
16. Spacing: The Minimum clearance between phase to switch shall be 1200 mm. The operating down rod shall be at a transverse distance of 300 mm from the outer limb of the switch. The center spacing between two post insulators of the same phase shall be 560 mm. in open position of the AB switches the moving blade shall rotate through an angle of 90 degree. This shall be exhibited in the drawing.
17. Non-threaded type spindle shall be provided for connection with down pipe.
18. Provision for operating handle earth with flexible copper wire shall be provided.

6. MARKING

Below parameters should be embossed on SS sheet of thickness 1mm with black background.

It should be riveted on MS channel of AB switch:

1. Rated Voltage
2. Manufacturer's Name
3. Month/Year of Manufacture
4. Serial Number
5. PO no.
6. Rated normal current in Amps
7. Rated one second short-time current in Amps

7. TESTS CERTIFICATE

7.1 Type Test

The A.B. switches shall be subjected to the following type tests in accordance with clause No. 6 of IS-9920 (Part-1)/2002.

- (i) Tests to prove that the temperature rise of any parts does not exceed the values specified in part-2 of this standard.
- (ii) Tests to prove the capability of the switch to carry the rated peak withstand current and the rated short time current.
- (iii) Measurement of the resistance of the main circuit.
- (iv) Tests to prove the ability of the switch to make and break the specified currents.
- (v) Tests to verify the insulation level including withstand tests at power frequency voltages on auxiliary equipment if any. Di-electric tests include impulse withstand tests, power frequency voltage withstand tests, and power frequency voltage withstand tests.
- (vi) Tests to prove satisfactory operation and Mechanical endurance.
- (vii) Tests to prove the integrity of the external insulation under conditions of the air pollution.

Note 1: The type test certificate should not be more than 5 years old as on due date of opening of tender.

Note 2: Type test certificate of polymeric post Insulator shall be submitted and shall be issued from CPRI/ERDA or Government lab only.

7.2 Acceptance Tests

The following acceptance test should be carried out as per IS: 9920 (P4/1985) on

number of samples selected from the offered lot.

- (i) Visual Inspection.
- (ii) Checking of Dimensions (of all parts as per the approved drawing).
- (iii) Power frequency voltage dry test.
- (iv) Measurement of the resistance of the main circuit.
- (v) Test to prove satisfactory operation
- (vi) Galvanizing test as per IS: 2633.
- (vii) Temperature rise test.

7.3 Routine Tests:

Supplier shall provide a control plan, which will be implemented on AB switches. Routine test reports should be submitted by the manufacturer with inspection call.

The following routine tests as outlined in clause No.4 of IS: 9920 (Part4/1985) shall be carried out by the manufacturer on each unit to check certain essential requirements.

- i) Power frequency voltage dry tests.
- ii) Measurement of the resistance of the main circuit.
- iii) Test to prove satisfactory operation.
- iv) Dimension check
- v) Galvanization test

The tenderer shall clearly indicate what testing facilities are available in the works of manufacturer & whether facilities are adequate to carry out all Acceptance & Routine Tests. These facilities should be available to TPCODL/TPNODL/TPSODL/TPWODL's representative if deputed or carry out or witness the tests in the manufacturer works.

8. TESTS

Along with the bid, the bidder must submit Type Test Reports on AB switches as per this technical specification, carried out within last five years from the date of opening of techno-commercial bid of the tender from CPRI/ERDA labs only. Otherwise the tender may be rejected.

9. PRE DISPATCH INSPECTION

Equipment shall be subject to inspection by a duly authorized representative of the TPCODL/TPNODL/TPSODL/TPWODL. Inspection may be made at any stage of manufacture at the option of the TPCODL/TPNODL/TPSODL/TPWODL and the equipment if found unsatisfactory as to workmanship or material is liable to rejection. Supplier shall grant free access to the places of manufacture to TPCODL/TPNODL/TPSODL/TPWODL's representatives at all times when the work is in progress. Inspection by the TPCODL/TPNODL/TPSODL/TPWODL authorized representatives shall not relieve the supplier of his obligation of furnishing equipment in accordance with the specifications.

Material shall be dispatched after specific MDCC (Material Dispatch Clearance Certificate) is issued by TPCODL/TPNODL/TPSODL/TPWODL. Following documents shall be sent along with material

- a) Routine Test reports
- b) MDCC issued by TPCODL/TPNODL/TPSODL/TPWODL
- c) Invoice in duplicate
- d) Packing list
- e) Drawings
- f) Delivery Challan
- g) Installation and maintenance Manual soft copy for all components
- h) Other Documents (as applicable)

10. INSPECTION AFTER RECEIPT AT STORES/SITE

The material received at TPCODL/TPNODL/TPSODL/TPWODL Store/Site will be inspected for acceptance and shall be liable for rejection if found different from the reports of the pre-dispatch inspection. If any deviation or anomaly observed at this stage same need to be rectified by bidder at bidders own cost at earliest.

11. GUARANTEE

Bidder shall stand guarantee towards design, materials, workmanship & quality of process/ manufacturing of items under this contract for due and intended performance of the same, as an integrated product delivered under this contract. In the event any defect is found by the Purchaser up to a period of at least 12 months from the date of commissioning or 24 months from the date of last supplies made under the contract whichever is earlier. Bidder shall be liable to undertake to replace/rectify such defects at its own costs, within mutually agreed time frame, and to the entire satisfaction of the Purchaser, failing which the Purchaser will be at liberty to get it replaced/rectified at Bidder's risks and costs and recover all such expenses plus the Purchaser's own charges (@ 20% of expenses incurred), from the Bidder or from the "Security cum Performance Deposit" as the case may be.

12. PACKING

Bidder shall ensure that all equipment covered by this specification shall be prepared for rail/road transport (local equipment) and be packed in such a manner as to protect it from damage in transit. The packing should be in such manner that during storage and its components should not be damaged. No single use plastic to be used in packing material. Packing should be done with environment friendly recyclable materials

13. TENDER SAMPLE

Bidder shall submit the sample of material with the offer (in case of first supply to TPCODL/TPNODL/TPSODL/TPWODL).

14. QUALITY CONTROL

The bidder shall submit with the offer, assurance plan indicating the various stages of inspection, the tests and checks which will be carried out on the material of construction, components during manufacture and after finishing, bought out items and fully assembled component and equipment including drives. As part of the plan, a schedule for stage and final inspection within the parameters of the delivery schedule shall be furnished. The TPCODL/TPNODL/TPSODL/TPWODL's or its nominated representative engineer shall have free access to the manufacturer/sub-supplier's works to carry out inspections. To ensure proper operation of Product the bidder shall provide onsite training of TPCODL/TPNODL/TPSODL/TPWODL teams as and when required. To ensure quality of installations bidder shall provide supervision support during impartation.

15. MINIMUM TESTING FACILITIES

Bidder shall have adequate in-house testing facilities for carrying out all routine tests & acceptance tests as per relevant International / Indian standards.

16. MANUFACTURING ACTIVITIES

The bidder shall get the approved drawing and GTP before start of manufacturing activity. The successful bidder will have to submit details of the offered design & components for approval as per specification. CAT-A/CAT-B is mandatory to start manufacturing.

17. SPARES, ACCESSORIES AND TOOLS

Not applicable.

18. DRAWINGS AND DOCUMENTS

Following documents to be submitted along with the bid for evaluation:

- a) Completely filled-in clause wise compliance of this specification.
- b) Signed and stamped copy of drawing
- c) Complete Type test reports
- d) Completely filled signed and stamped copy of tender document.
- e) Any other requisite document
- f) Experience List.

Following documents shall be submitted after award of RC/PO before manufacturing:

- a) Completely filled-in clause wise compliance of the specification.
- b) Signed and stamped copy of GA drawing
- c) Signed and stamped copy of installation drawing
- d) Compliance of all undertaking submitted during technical evaluation, if any
- e) Type test Certificates for each specified test if not submit during technical evaluation

Following Drawings/Documents shall be submitted after the award of the contract.

S. No	Description	For Approval	For Review Information	Final Submission
1	Technical Parameters	√		√
2	Manual/Catalogues/drawings for all components.		√	
3	Technical details and test certificates.		√	√
4	Installation Instructions		√	√
5	Transport/shipping dimension drawing		√	√
6	QA & QC Plan	√	√	√
7	Routine, Acceptance and Type test Certificates	√	√	√

All the Documents and Drawings shall be in English Language.

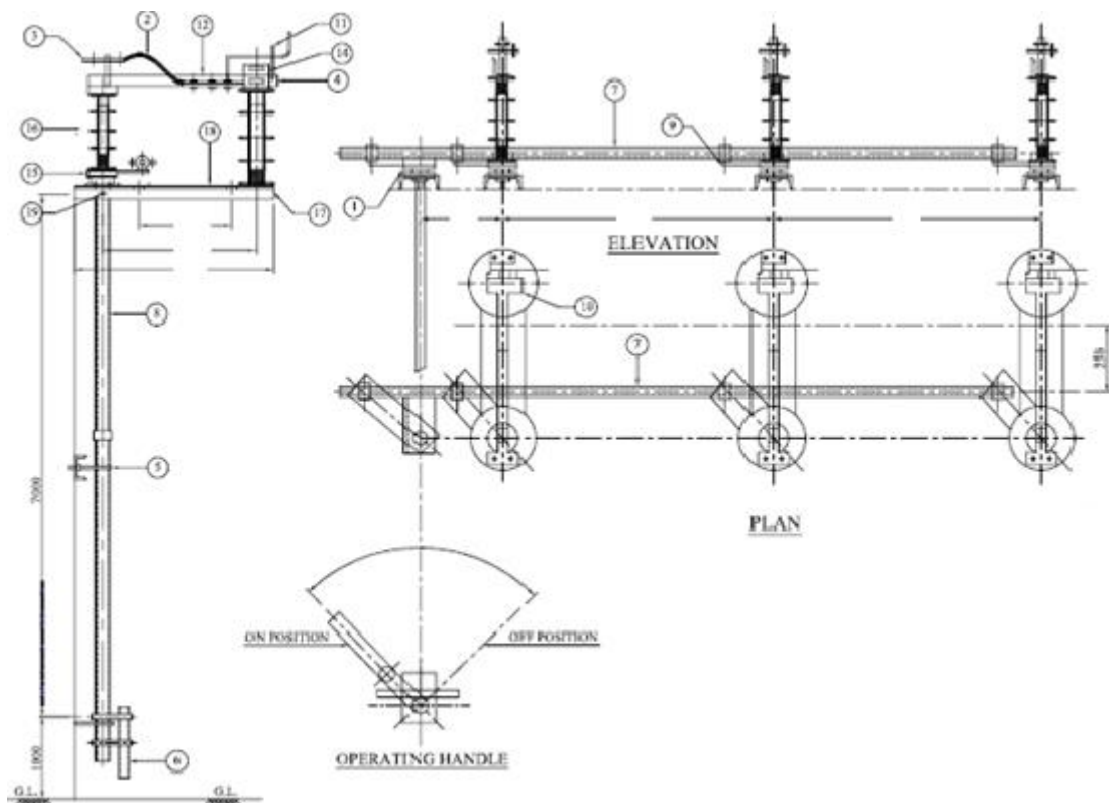

Indicative drawing of 33 KV 400A AB Switch

19. GUARANTEED TECHNICAL PARTICULARS

Completely filled-in clause wise compliance of this specification along with bid.

20. SCHEDULE OF DEVIATIONS



Specification No: ENG-EHV-1018

Specification Name: Technical Specification for 33 kV AB switch (400 A)

(TO BE ENCLOSED WITH TECHNICAL BID)

All deviations from this specification shall be set out by the Bidders, clause by Clause in this schedule. Unless specifically mentioned in this Schedule, the tender shall be deemed to confirm the purchaser's specifications:

SL. No	Clause No.	Details of deviation with justifications

We confirm that there are no deviations apart from those detailed above.

Seal of the Company:

Signature

Designation

STANDARD TECHNICAL SPECIFICATION COVER SHEET

Specification No. : ENG-HV-2013

Specification Name : Technical Specification for 11 kV AB switch (400 A & 200 A)

YASHOBANTA ROUT	DEEPAK BADATYA	J DURAIRAJ	Sandeep Saurav	KHAJAN BHARDWAJ	POURUSH GARG
Prepared by	Reviewed by	Reviewed by	Reviewed by	Approved by	Released by
TPCODL	TPNODL	TPWODL	TPSODL	TPCODL	TPCODL
07-01-2023	07-01-2023	09-01-2023	10-01-2023	10-01-2023	12-01-2023

Property of TATA POWER ODISHA DISCOMs – Not to be reproduced without permission of TPCODL/ TPNODL/ TPSODL/ TPWODL

CONTENTS

- 1. SCOPE**
- 2. APPLICABLE STANDARDS**
- 3. CLIMATIC CONDITIONS OF THE INSTALLATION**
- 4. GENERAL TECHNICAL REQUIREMENTS**
- 5. GENERAL CONSTRUCTIONS/REQUIREMENTS**
- 6. MARKING**
- 7. TESTS**
- 8. TYPE TEST CERTIFICATES**
- 9. PRE-DISPATCH INSPECTION**
- 10. INSPECTION AFTER RECEIPT AT STORES**
- 11. GUARANTEE**
- 12. PACKING**
- 13. TENDER SAMPLE**
- 14. QUALITY CONTROL**
- 15. MINIMUM TESTING FACILITIES**
- 16. MANUFACTURING ACTIVITIES**
- 17. SPARES, ACCESSORIES AND TOOLS**
- 18. DRAWINGS AND DOCUMENTS**
- 19. GUARANTEED TECHNICAL PARTICULARS**
- 20. SCHEDULE OF DEVIATIONS**

1. SCOPE

This specification covers design, manufacturing, testing at manufacturer's works, inspection, packing & delivery of 11 kV Air Break Switch with accessories for out-door installation for use on transformer centers and tap line in Central Odisha. Aforesaid item(s) shall include loading and unloading at anywhere in Odisha.

It is not the intent to specify completely herein all the details of design and construction of Air Break Switches. However, AB Switches will confirm in all respects to high standards of engineering design and workmanship and shall be capable of performing in continuous Commercial operation up to the supplier's guarantee, in a manner acceptable to the purchaser, who will interpret the meanings of drawings and specifications and shall have the power to reject any material, which in his judgment i.e. not in accordance with the specifications/drawings.

The AB Switches offered shall be complete with all components necessary for its effective and trouble-free operation along with associated equipment etc. such components shall be deemed to be within the scope of supplier's supply, irrespective of whether those are specifically brought out in the specification and/or in order or not. Also similar parts particularly removable ones shall be inter-changeable.

2. APPLICABLE STANDARDS

The equipment covered by this specification shall unless otherwise stated, be designed, manufactured and tested in accordance with the latest editions of the following Indian, International Standards and shall conform to the regulations of the local authorities:

Ref. IS	Description
IS 9920 (part-I to V)	Specification for helically formed fittings for Overhead lines up to 33 kV
IS 2633 (Part 1)	Method for testing uniformity of coating on zinc coated
IEC 62231	Composite station post insulators for substations with a.c. voltages greater than 1 000 V up to 245 kV – Definitions, test methods and acceptance criteria
IEC 60168:1994+AMD1:1997+AMD2:2000 CSV	Tests on indoor and outdoor post insulators of ceramic material or glass for systems with nominal voltages greater than 1000 V
IS 9530	Recommended practice for silver plating
IS 5925	Recommended practice for silver plating for general engineering purposes
BS 2816	Testing of silver plating thickness

IS 1239	GI pipe('B' class or Medium class)
IS: 5561	Electrical Power Connectors
IS 2062	Hot rolled medium and high tensile structural steel — specification

3. CLIMATIC CONDITIONS OF THE INSTALLATION

SL.NO.	CONDITONS	VALUES
1	Max. altitude above sea level	1200m
2	Max. Ambient Temperature	50 °C
3	Max. Daily average ambient temp	35 °C
4	Min Ambient Temp	0 °C
5	Maximum temperature attainable by an object exposed to sun	60 °C
6	Maximum Humidity	95%
7	Minimum Humidity	10%
8	Average No. of thunderstorm days per annum	70
9	Average Annual Rainfall	150 cm
10	Average No. of rainy days per annum	120
11	Thermal Resistivity of soil	150 Deg. Ccm/W
12	Wind Pressure	126 kg/sq. m up to an elevation of 10 meter.
14	Earthquakes of intensity in horizontal direction	equivalent to seismic acceleration of 0.3g
15	Earthquakes of intensity in vertical direction	equivalent to seismic acceleration of 0.15g
16	Wind velocity	300 km/hr.

Environmentally, some of the regions, where the work will take place include coastal areas, subject to high relative humidity, which can give rise to condensation. Onshore winds will frequently be salt laden. On occasions, the combination of salt and condensation may create pollution conditions for outdoor insulators. Some places are in heavily industrial polluted areas. Therefore, Outdoor material and equipment shall be designed and protected for use in exposed, heavily polluted, salty, corrosive and humid coastal atmosphere.

The atmosphere is generally laden with mild acid and dust in suspension during the dry months and is subjected to fog in cold months. The design of equipment and accessories shall be suitable to withstand seismic forces corresponding to an acceleration of 0.1 g.

4. GENERAL TECHNICAL REQUIREMENTS

SL. NO.	TECHNICAL PARTICULARS	DESIRED VALUE	
		400 Amps AB Switch	200 Amps AB Switch
1	Rating of AB Switch	400 Amps AB Switch	200 Amps AB Switch
1.a	Reference standards (latest amend.)	IS 9920, IEC 129, IEC 62231, IS 1239	
2	Installation	Outdoor	Outdoor
3	Suitable for Mounting	Horizontal Rotating Type	
4	Type	3 Pole	3 Pole
5	Service Voltage	11 kV	11 kV
6	Rated Voltage	12 kV	12 kV
7	Rated Frequency	50 Hz	50 Hz
8	Current Carrying Capacity	400 Amps	200 Amps
9	Rated short time current	16 kA for 1sec	16 kA for 1sec
10	Rated peak withstand current	40 kA	40 kA
11	Rated main active load breaking capacity	10 Amp	10 Amp
12	Rated line charging breaking capacity	2.5A	2.5A
12.a	Rated Cable charging breaking capacity	10A	10A
13	Rated Transformer off load breaking Capacity	6.3A	6.3A
14	One minute power frequency withstand voltage Dry	35kV RMS	35kV RMS
15	One minute power frequency withstand voltage Wet	35kV RMS	35kV RMS
16	Dry flashover Voltage	55kV	55kV
17	Power Frequency puncture withstand voltage	1.3 times of actual dry flashover Voltage	
18	Visible Discharge Voltage	9kV RMS	
19	1 Minute Power Frequency withstand voltage between pole and earth	28kV RMS	28kV RMS
20	1 Minute Power frequency withstand voltage across the isolation distance	32kV RMS	32kV RMS
21	Impulse withstand voltage for positive and negative polarity (1.2 / 50) micro second wave)		
a	Across Isolating distance	85kV Peak	85kV Peak
b	To earth and between poles	75kV Peak	75kV Peak
22	No. of Post Per Pole (Polymeric, IEC 62231)	2	2
23	Total No. of post	6	6
24	Minimum Creepage Distance	320 mm	320mm

SL. NO.	TECHNICAL PARTICULARS	DESIRED VALUE	
24.a	FRP Dia. of the Post Insulator (min.)	24mm	24mm
24.b	Dai of Weather sheds	>100mm	>100mm
24.c	Thickness of Housing (min)	3mm	3mm
25.d	Type of Sheds	Aerodynamic	Aerodynamic
25	Phase to Phase Clearance	760mm	760mm
26	Isolation Distance in switch open condition	380mm	380 mm
27	Vertical clearance from Top of Insulator cap to mounting channel	254mm (min)	254mm (min)
28	Copper contacts Temp in Air should not exceed	65Degree	65 Degree
29	Size of fixed contacts (Copper Type Electrolytic with silver plated) (coating thickness not less than 10 microns)	80mmx50mmx8mm (50x8x2 Fingers)	70mmx35mmx6mm (35x6x2 Finger)
30	Size of Moving contacts (Copper Type Electrolytic with silver plated) (coating thickness not less than 10 microns)	220mmx50mmx8mm	220mmx35mmx6mm
31	Moving Contact supporting Angle	50mmx50mmx5mm	45mmx45mmx5mm
32	Size of rods used for arcing horns	10 mm	8 mm
33	Insulation for tinned Copper braid/rope	Polyolefin, (RSFR-H) type	Polyolefin, (RSFR-H) type
34	Copper Flexible BRAIDED Tape - 320mm Long, Tined plated with Brass Nut, bolt & Washers	450gm /Mtr	450gm /Mtr
35	Minimum size*Length of Coupling Hot Dip GI Solid Pipe for Phase coupling pipe, B Class (Nominal Bore)	25mm Dia &1800 mm long	25mm Dia &1800mm long
36	Operating Down Pipe, B class (IS 1239) (Nominal bore)	32mm Dia & 7Mtr Long (one piece)	32mm Dia & 7Mtr Long (one piece)
37	Temperature Rise Limit (w.r.t ambient temp) - Tinned Copper contacts - Terminals - Metal Parts	65°C 65°C 40°C	65°C 65°C 40°C
38	Bearings	4 nos. self-lubricating bearing to be provided with grease nipple including 4 th bearing being a thrust bearing.	
39	Locking arrangement	Provision for pad locking at both 'ON' & 'OFF' Position	
40	Earth Terminal	M12 Bolts with nuts and flat washer shall be provided at base channel as earthing Terminal.	
41	'T' Connection	The T connection provided on the channel having 'moving contact' shall be G.I Nut & bolt at the bottom end to facilitate replacement of this unit only during	

SL. NO.	TECHNICAL PARTICULARS	DESIRED VALUE
		requirements & avoid entire change of arm.
42	'I' bolt	The I bolt shall be longer with 75 mm thread.
43	Mounting Channel HDG 100 microns	75x40x4.8 mm hot dip galvanized channel length 480 mm min. (C/C slotted hole 18x 36 mm- 250mm)
44	Connectors	Connectors shall be of hard drawn electrolytic copper or brass. The connector should be of 4 bolted type and suitable for 55- 100 sqmm AAAC conductor. Or SOCKET: Two no. of bimetallic copper sockets shall be used at both ends suitable for 55-100 sqmm AAAC conductor.
45	Marking/Engraving (Parameters should be embossed on SS sheet of thickness 1mm with black background. It should be riveted on MS channel of AB switch)	1. Rated Voltage 2. Manufacturer Name 3. Month/Year of Manufacture 4. Serial No. 5. PO No. 6. Rated Normal Current in Amps 7. Rated One Second Short-Time Current
46	Pressure Spring	Stainless steel

5. GENERAL CONSTRUCTIONS/REQUIREMENTS

- The Air break switch shall be outdoor type, rotating type gang operated and shall be suitable for horizontal installation having 2 no. of polymeric post insulators per phase.
- The Rotating type operating mechanism shall be suitable for manual operation from ground level and shall be designed in such way that all the three phases shall open and close simultaneously in smooth way.
- The air break switch shall be with the arcing horns, the sizes of the rods used for the arcing horns would be 10mm for 400 A and 8mm for 200 A AB switch of M.S. Hot dip galvanized.
- The current carrying connectors should be two-bolt type having nuts and bolts, with spring washer and plane washer.
- Each joint shall be provided with one plane and one spring of not less than 2mm thickness.
- Connectors shall be of H D electrolytic copper.
- The minimum cross section for fixed contact shall be 400 sq.mm for 400 Amp AB Switch and 200 sq.mm for 200 Amp AB Switch.
- Tinned Copper braid/rope shall be insulated by Polyolefin (RSFR-H) type to prevent animal electrocution. It shall be 320 mm long minimum and shall weigh 450 G/M. It shall be punched at both ends.
- All ferrous parts shall be hot dip galvanized with heavy coating after proper surface treatment as per standards. Coating thickness shall not be less than 100 micron at any point.
- All Copper parts shall be silver plated as per relevant standards and coating thickness not less than 10 microns at any point.
- Equipment grounding shall be provided by bidder at two points with terminals. .
- All the nut bolt used must be Hot dip Galvanized and of size not less than M10.
- A rigid base of galvanized steel channel of size approx.75x40x4.8 mm Length 480 mm min. (C/C slotted hole 18x 36 mm- 250mm shall be provided with clamps and bolts for Horizontal mounting firmly on steel structure.
- Each member of the switch shall be free from Rust, sharp edges, burr and any kind of deformation.

15. The phase coupling rod, operation rod with intermediate guide braided with flexible electrolytic copper, tail piece of required current carrying capacity and operation mechanism with 'ON' & 'OFF' positions shall be provided.
16. The operation rod shall be medium gage of 32mm diameter nominal bore G.I. pipe single length 7 meters. The phase coupling rod for gang operation shall be of medium gauge 25mm dia. & 1800 mm length nominal bore G.I. pipe.
17. Non-threaded type spindle shall be provided for connection with down pipe.
18. Provision for operating handle earth with flexible copper wire shall be provided.

Technical particulars	400 Amps AB Switch	200 Amps AB Switch
Switching Blades	It shall be made out of electrolytic copper with silver plated. The approximate size shall be 220mm x50 x 8mm for 11 KV. The switch shall have such a spring mechanism so as to ensure that the speed of the opening of contact is independent of speed of manual operation.	It shall be made out of electrolytic copper with silver plated. The approximate size shall be 220mmX35X 6mm. The Switch shall have such a spring mechanism so as to ensure that the speed of the opening of contact is independent of speed of manual operation.
Fixed Contacts	The fixed jaw type female contacts (80x50x8)mm for 11 KV shall be made of electrolytic copper (minimum 95 % copper composition) duly electroplated controlled by phosphorus bronze/Stainless Steel high pressure spring housed in robust G.I. Cover. It is essential that provision shall be made in fixed female contacts to take the shock arising from the closing of moving contact blade without the same being transmitted to the post insulator.	The Fixed Jaw type female contacts of size (70x35x6) mm shall be made of electrolytic copper (minimum 95% copper composition) duly silver coated controlled by phosphorous bronze/Stainless steel high pressure spring housed in robust G.I. Cover. It is essential that provision shall be made in fixed female contracts to take the shock arising from the closing of move contract blade without the same being transmitted to the post insulator.
Terminal pads	Terminal connectors for both movable and fixed should be of copper flats of same size similar to that of moving contact blades (minimum 95% copper composition). The fixed connector shall of size 80 mm x 50 x 8 mm and the size of movable connector shall be size 80 x 50 x 8 mm with machine finishing duly silver plated with 2 nos. of 12mm dia. brass bolts, double nuts, plain washers & spring washers should be provided along with 2 nos. solder less bimetallic sockets for each connector suitable sockets for each connector suitable up to 55- 100 mm ² AAA conductor.	Terminal connectors shall be robust in design. The size of fixed connector shall be (70 X 35 X 6 mm) and size of movable connector shall be of (70 X 35) X (70 X 35) X 6mm of copper casting with uniform machine finishing duly silver plated made out of minimum 95% copper composition with 2 nos. of 12mm dia. holes provided with suitable brass bolts and double nuts, flat washers, spring washers & 2nos.bimetallic solder less sockets suitable up to 55-100 mm ² AAA conductor.

6. MARKING

Below parameters should be embossed on SS sheet of thickness 1mm with black background. It should be riveted on MS channel of AB switch:

1. Rated Voltage
2. Manufacturer's Name
3. Month/Year of Manufacture
4. Serial Number
5. PO no.

6. Rated normal current in Amps
7. Rated one second short-time current in Amps

7. TESTS CERTIFICATE

7.1 Type Test

The A.B. switches shall be subjected to the following type tests in accordance with clause No. 6 of IS-9920 (Part-1)/2002.

- (i) Tests to prove that the temperature rise of any parts does not exceed the values specified in part-2 of this standard.
- (ii) Tests to prove the capability of the switch to carry the rated peak withstand current and the rated short time current.
- (iii) Measurement of the resistance of the main circuit.
- (iv) Tests to prove the ability of the switch to make and break the specified currents.
- (v) Tests to verify the insulation level including withstand tests at power frequency voltages on auxiliary equipment if any. Di-electric tests include impulse withstand tests, power frequency voltage withstand tests, and power frequency voltage withstand tests.
- (vi) Tests to prove satisfactory operation and Mechanical endurance.
- (vii) Tests to prove the integrity of the external insulation under conditions of the air pollution.

Note 1: The type test certificate should not be more than 5 years old as on due date of opening of tender.

Note 2: Type test certificate of polymeric post Insulator shall be submitted and shall be issued from CPRI/ERDA or Government lab only.

7.2 Acceptance Tests

The following acceptance test should be carried out as per IS: 9920 (P4/1985) on number of samples selected from the offered lot.

- (i) Visual Inspection.
- (ii) Checking of Dimensions (of all parts as per the approved drawing).
- (iii) Power frequency voltage dry test.
- (iv) Measurement of the resistance of the main circuit.
- (v) Test to prove satisfactory operation
- (vi) Galvanizing test as per IS: 2633.
- (vii) Temperature rise test.

7.3 Routine Tests:

Supplier shall provide a control plan, which will be implemented on AB switches. Routine test reports should be submitted by the manufacturer with inspection call.

The following routine tests as outlined in clause No.4 of IS: 9920 (Part4/1985) shall be carried out by the manufacturer on each unit to check certain essential requirements.

- i) Power frequency voltage dry tests.

- ii) Measurement of the resistance of the main circuit.
- iii) Test to prove satisfactory operation.

The tenderer shall clearly indicate what testing facilities are available in the works of manufacturer & whether facilities are adequate to carry out all Acceptance & Routine Tests. These facilities should be available to TPCODL/TPNODL/TPSODL/TPWODL's representative if deputed or carry out or witness the tests in the manufacturer works.

8. TESTS

Along with the bid, the bidder must submit Type Test Reports on AB switches as per this technical specification, carried out within last five years from the date of opening of techno-commercial bid of the tender from CPRI/ERDA labs only. Otherwise the tender may be rejected.

9. PRE DISPATCH INSPECTION

Equipment shall be subject to inspection by a duly authorized representative of the TPCODL/TPNODL/TPSODL/TPWODL. Inspection may be made at any stage of manufacture at the option of the TPCODL/TPNODL/TPSODL/TPWODL and the equipment if found unsatisfactory as to workmanship or material is liable to rejection. Supplier shall grant free access to the places of manufacture to TPCODL/TPNODL/TPSODL/TPWODL's representatives at all times when the work is in progress. Inspection by the TPCODL/TPNODL/TPSODL/TPWODL authorized representatives shall not relieve the supplier of his obligation of furnishing equipment in accordance with the specifications.

Material shall be dispatched after specific MDCC (Material Dispatch Clearance Certificate) is issued by TPCODL/TPNODL/TPSODL/TPWODL. Following documents shall be sent along with material

- a) Routine Test reports
- b) MDCC issued by TPCODL/TPNODL/TPSODL/TPWODL
- c) Invoice in duplicate
- d) Packing list
- e) Drawings
- f) Delivery Challan
- g) Installation and maintenance Manual soft copy for all components
- h) Other Documents (as applicable)

10. INSPECTION AFTER RECEIPT AT STORES/SITE

The material received at TPCODL/TPNODL/TPSODL/TPWODL Store/Site will be inspected for acceptance and shall be liable for rejection if found different from the reports

of the pre-dispatch inspection. If any deviation or anomaly observed at this stage same need to be rectified by bidder at bidders own cost at earliest.

11. GUARANTEE

Bidder shall stand guarantee towards design, materials, workmanship & quality of process/ manufacturing of items under this contract for due and intended performance of the same, as an integrated product delivered under this contract. In the event any defect is found by the Purchaser up to a period of at least 12 months from the date of commissioning or 24 months from the date of last supplies made under the contract whichever is earlier. Bidder shall be liable to undertake to replace/rectify such defects at its own costs, within mutually agreed time frame, and to the entire satisfaction of the Purchaser, failing which the Purchaser will be at liberty to get it replaced/rectified at Bidder's risks and costs and recover all such expenses plus the Purchaser's own charges (@ 20% of expenses incurred), from the Bidder or from the "Security cum Performance Deposit" as the case may be.

12. PACKING

Bidder shall ensure that all equipment covered by this specification shall be prepared for rail/road transport (local equipment) and be packed in such a manner as to protect it from damage in transit. The packing should be in such manner that during storage and its components should not be damaged. No single use plastic to be used in packing material. Packing should be done with environment friendly recyclable materials

13. TENDER SAMPLE

Bidder shall submit the sample of material with the offer (in case of first supply to TPCODL/TPNODL/TPSODL/TPWODL).

14. QUALITY CONTROL

The bidder shall submit with the offer, assurance plan indicating the various stages of inspection, the tests and checks which will be carried out on the material of construction, components during manufacture and after finishing, bought out items and fully assembled component and equipment including drives. As part of the plan, a schedule for stage and final inspection within the parameters of the delivery schedule shall be furnished. The TPCODL/TPNODL/TPSODL/TPWODL's or its nominated representative engineer shall have free access to the manufacturer/sub-supplier's works to carry out inspections. To ensure proper operation of Product the bidder shall provide onsite training of TPCODL/TPNODL/TPSODL/TPWODL teams as and when required. To ensure quality of installations bidder shall provide supervision support during impartation.

15. MINIMUM TESTING FACILITIES

Bidder shall have adequate in-house testing facilities for carrying out all routine tests &

acceptance tests as per relevant International / Indian standards.

16. MANUFACTURING ACTIVITIES

The bidder shall get the approved drawing and GTP before start of manufacturing activity. The successful bidder will have to submit details of the offered design & components for approval as per specification. CAT-A/CAT-B is mandatory to start manufacturing.

17. SPARES, ACCESSORIES AND TOOLS

Not applicable.

18. DRAWINGS AND DOCUMENTS

Following documents to be submitted along with the bid for evaluation:

- a) Completely filled-in clause wise compliance of this specification.
- b) Signed and stamped copy of drawing
- c) Complete Type test reports
- d) Completely filled signed and stamped copy of tender document.
- e) Any other requisite document
- f) Experience List.

Following documents shall be submitted after award of RC/PO before manufacturing:

- a) Completely filled-in clause wise compliance of the specification.
- b) Signed and stamped copy of GA drawing
- c) Signed and stamped copy of installation drawing
- d) Compliance of all undertaking submitted during technical evaluation, if any
- e) Type test Certificates for each specified test if not submit during technical evaluation

Following Drawings/Documents shall be submitted after the award of the contract.

S. No	Description	For Approval	For Review Information	Final Submission
1	Technical Parameters	√		√
2	Manual/Catalogues/drawings for all components.		√	
3	Technical details and test certificates.		√	√
4	Installation Instructions		√	√
5	Transport/shipping dimension drawing		√	√
6	QA & QC Plan	√	√	√
7	Routine, Acceptance and Type test Certificates	√	√	√

All the Documents and Drawings shall be in English Language.

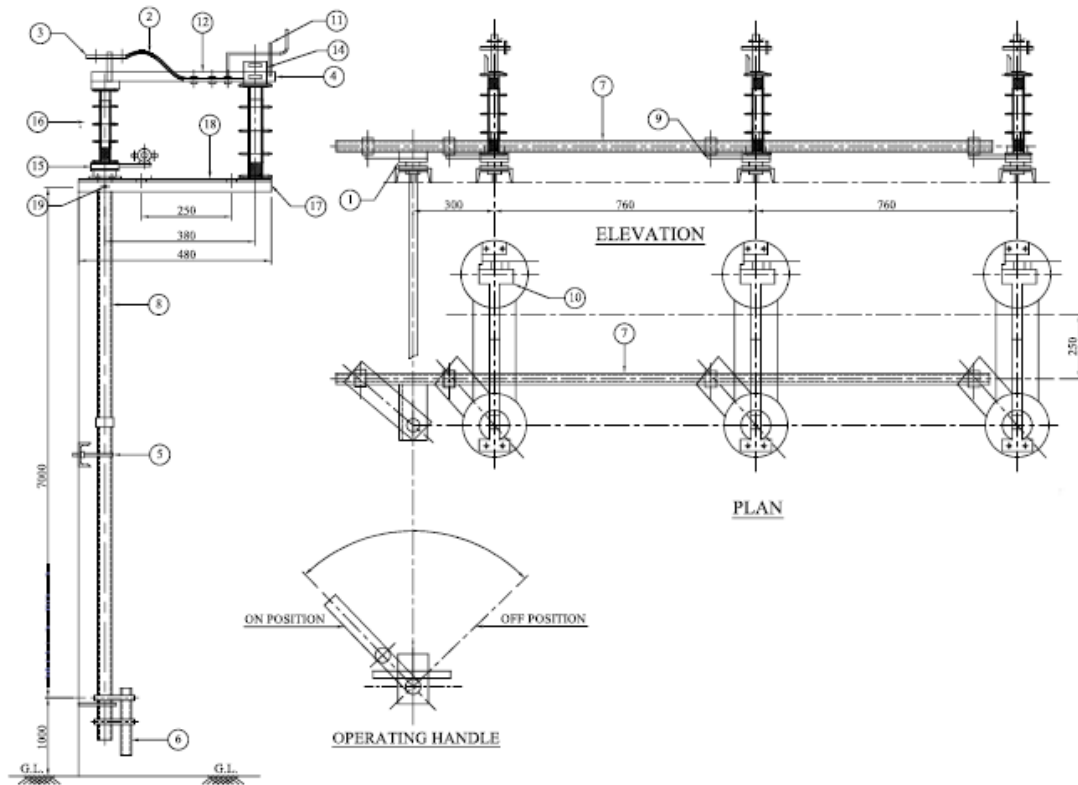

Indicative drawing of 11 KV 400 A and 200 A AB Switch

19. GUARANTEED TECHNICAL PARTICULARS

Completely filled-in clause wise compliance of this specification along with bid.

20. SCHEDULE OF DEVIATIONS

(TO BE ENCLOSED WITH TECHNICAL BID)

All deviations from this specification shall be set out by the Bidders, clause by Clause in this schedule. Unless specifically mentioned in this Schedule, the tender shall be deemed to confirm the purchaser's specifications:

SL. No	Clause No.	Details of deviation with justifications

We confirm that there are no deviations apart from those detailed above.

Seal of the Company:

Signature

Designation

CONTENTS

CLAUSE NO.	DESCRIPTION
1.0	ORGANIZATIONAL VALUES
2.0	ETHICS
3.0	CONTRACT PARAMETERS
3.1	Issue/Award of Contract
3.2	Contract Commencement Date
3.3	Contract Completion Date
3.4	Contract Period/ Time
3.5	Contract Execution Completion Date
3.6	Contract Price /Value
3.7	Contract Document
3.8	Contract Language
3.9	Reverse Auction
4.0	SCOPE OF WORK
5.0	PRICES/RATES/TAXES
5.1	Changes in statutory Tax Structure
6.0	TERMS OF PAYMENT
6.1	Quantity Variation
6.2	Full and Final Payment
7.0	MODE OF PAYMENT
8.0	SECURITY CUM PERFORMANCE DEPOSIT
9.0	STATUTORY COMPLIANCE
9.1	Compliance to Various Acts
9.2	SA 8000
9.3	Affirmative Action
10.0	QUALITY
10.1	Knowledge of Requirements
10.2	Material/Equipment/Works Quality
10.3	Adherence to Rules & Regulations
10.4	Specifications and Standards
11.0	INSPECTION/PARTICIPATION
11.1	Right to Carry Out Inspection
11.2	Facilitating Inspection
11.3	Third Party Nomination
11.4	Waiver of Inspections
11.5	Incorrect Inspection Call

CONTENTS	
CLAUSE NO.	DESCRIPTION
12.0	MDCC & DELIVERY OF MATERIALS
12.1	Material Dispatch Clearance Certificate
12.2	Right to Rejection on Receipt
12.3	Consignee
12.4	Submission of Mandatory Documents on Delivery
12.5	Dispatch and Delivery Instructions
13.0	GUARANTEE
13.1	Guarantee of Performance
13.2	Guarantee period
13.3	Failure in Guarantee period (GP)
13.4	Cost of repairs on failure in GP
13.5	Guarantee Period for Goods Outsourced
13.6	Latent Defect
13.7	Support beyond the Guarantee Period
14.0	LIQUIDATED DAMAGES
14.1	LD Waiver Request
15.0	UNLAWFUL ACTIVITIES
16.0	CONFIDENTIALITY
16.1	Documents
16.2	Geographical Data
16.3	Associate's Processes
16.4	Exclusions
16.5	Violation
17.0	INTELLECTUAL PROPERTY RIGHTS
18.0	INDEMNITY
19.0	LIABILITY & LIMITATIONS
19.1	Liability
19.2	Limitation of Liability
20.0	FORCE MAJEURE
21.0	SUSPENSION OF CONTRACT
21.1	Suspension for Convenience
21.2	Suspension for Breach of Contract Conditions
21.3	Compensation in lieu of Suspension
22.0	TERMINATION OF CONTRACT
22.1	Termination for Default/Breach of Contract
22.2	Termination for Convenience of Associate
22.3	Termination for Convenience of TPCODL

Doc. Title	GENERAL CONDITIONS OF CONTRACT FOR SUPPLY ORDERS	
Rev. No	0	Page 3 of 43

CONTENTS	
CLAUSE NO.	DESCRIPTION
23.0	DISPUTE RESOLUTION AND ARBITRATION
23.1	Governing Laws and jurisdiction
24.0	ATTRIBUTES OF GCC
24.1	Cancellation
24.2	Severability
24.3	Order of Priority
25.0	ERRORS AND OMISSIONS
26.0	TRANSFER OF TITLES
27.0	INSURANCE
28.0	SUGGESTIONS & FEEDBACK
29.0	CONTACT POINTS
30.0	LIST OF ANNEXURES

GENERAL CONDITIONS OF CONTRACT

Doc. Title	GENERAL CONDITIONS OF CONTRACT FOR SUPPLY ORDERS	
Rev. No	0	Page 4 of 43

1.0 ORGANIZATIONAL VALUES

The Tata Group has always been a value driven organization. These values continue to direct the Group's growth and businesses. The six core Tata Values underpinning the way we do business are:

Integrity - We must conduct our business fairly, with honesty and transparency. Everything we do must stand the test of public scrutiny.

Understanding - We must be caring, respectful, compassionate and humanitarian towards our colleagues and customers around the world and always work for the benefit of India.

Excellence - We must constantly strive to achieve the highest possible standards in our day to day work and in the quality of goods and services we provide.

Unity - We must work cohesively with our colleagues across the group and with our customers and partners around the world to build strong relationships based on tolerance, understanding and mutual co-operation.

Responsibility - We must continue to be responsible and sensitive to the countries, communities and environments in which we work, always ensuring that what comes from the people goes back to the people many times over.

Agility - We must work in a speedy and responsive manner and be proactive and innovative in our approach.

2.0 ETHICS

In our effort towards Excellence and in Management of Business Ethics at TPCODL, an Ethics Management Team is constituted.

The main objective of the Ethics Management Team is to:

1. Record, address and allay the issues and concerns on ethics raised by different stakeholders like employees, consumers, vendors, Associates etc. by initiating immediate corrective actions.
2. Ensure proper communication of the ethics policies and guidelines through prominent displays at all offices of TPCODL and through printed declarations in all concerned documents where external stakeholders are involved.
3. Ensure proper framework of policies as preventive measures against any ethics violation recorded by them.
4. Prepare and submit MIS of all issues and concerns, corrective and preventive actions on monthly basis to the top management for their information.

All Associates and Stakeholders are requested to register any grievance on ethics violation on our website www.tpccentralodisha.com.

3.0 CONTRACT PARAMETERS

3.1 Issue/Award of Contract

TPCODL awards the contract to the Associate in writing in the form of Purchase Order (PO) or Rate Contract (RC), hereafter referred as Contract, through in any or all of following modes physical handover / post / e-mail / web document / fax with all the attachments/enclosures which shall be part of the contract document.

Doc. Title	GENERAL CONDITIONS OF CONTRACT FOR SUPPLY ORDERS	
Rev. No	0	Page 5 of 43

On receipt of the contract, the associate shall return to TPCODL copy of the contract document duly signed by legally authorized representative of associate, within two days of Effective Date of Contract for contracts having contract execution time less than 30 days and within five days for all other contracts.

3.2 Contract Commencement Date

The date of issue/award of contract shall be the Effective Date of Contract or Contract Commencement date.

3.3 Contract Completion Date

The date of expiry of Guarantee Period shall be deemed as the Contract Completion Date.

3.4 Contract Period/Time

The period from Contract Commencement Date to Contract Completion Date shall be deemed as the Contract Period/Time.

3.5 Contract Execution Completion Date

The stipulated date for completing the supply as per schedule of quantities shall be deemed as the Contract Execution Completion Date.

3.6 Contract Price /Value

The total all inclusive price/value mentioned in the PO/RC is the Contract Price/Value and is based on the quantity, unit rates and prices quoted and awarded and shall be subject to adjustment based on actual quantities supplied and accepted and certified by the authorized representative of the company unless otherwise specified in schedule of quantities or in contract documents.

3.7 Contract Document

The Contract Document shall mean and include but not limited to the following:

- NIT/Tender Enquiry, QR, Instruction to Bidders, Special Condition of Contract (SCC) of tender, GCC, Technical & Commercial Specifications including relevant annexure and attachments).
- Bids & Proposals Received from Associate including relevant annexure/attachments.
- RC/PO with agreed deviations from the tender/bid documents.
- All the Inspection and Test reports, Detailed Engineering Drawings.
- Material Dispatch Clearance Certificate (MDCC).
- Minutes of Meeting (MoM)

3.8 Contract Language

All documents, instructions, catalogues, brochures, pamphlets, design data, norms and calculations, drawings, operation, maintenance and safety manuals, reports, labels, on deliveries and any other data shall be in English Language.

The Contract documents and all correspondence between the TPCODL, Third Parties associated with the contract, and the Associate shall be in English language.

However, all signboards required indicating "Danger" and/or security at site and otherwise statutory required shall be in English, Hindi, and local languages.

Doc. Title	GENERAL CONDITIONS OF CONTRACT FOR SUPPLY ORDERS	
Rev. No	0	Page 6 of 43

3.9 Reverse Auction

TPCODL reserves the right to conduct the reverse auction (instead of public opening of price bids) for the products / services being asked for in the tender. The terms and conditions for such reverse auction events shall be as per the Acceptance Form attached in Annexure F.

4.0 SCOPE OF WORK

All the activities that are to be undertaken by the Associate to realize the contractual deliverables in completeness form Scope of Work. Following clauses list, but not limited to, major requirements of the scope of work.

The associate shall satisfy himself and undertake fully the technical/commercial requirements of items to be supplied as listed in the Schedule of Quantities together with the tests to be performed /test reports to be furnished before dispatch, arrangement of stage and final inspections during manufacturing as per terms and conditions of contract, technical parameters & delivery terms and conditions including transit insurance to be met in order to fully meet TPCODL's requirements.

Completeness: Any supplies and services which might have not been specifically mentioned in the Contract but are necessary for the scope mentioned in Special Terms & Conditions and/or completeness of the works at the highest possible level, including any royalties, license fees & compensation to be paid, whether incurred by the associates or by a third party for the work covered in the scope, regardless of when incurred, shall be supplied/provided by the associate without any extra cost and within the time schedule for efficient, smooth and satisfactory operation and maintenance of the works at the highest possible level under Indian conditions (but according to international standards for facility of this type), unless expressly excluded from the scope of supplies and services in this Contract.

TPCODL have the right, during the performance of the Contract, to change the scope and/or technical character of the Project and/or of the supplies and services stipulated in the Contract by submitting a request in writing to the Associate. The Associate shall, within fifteen days of receipt of such request from the TPCODL, provide Purchaser with a reasonably detailed estimate of the cost of the change outlined in the request.

In the event, TPCODL requests a change, the Contract price and time shall be adjusted upwards or downwards, as the case may be and shall be mutually agreed to. The associate shall not be entitled to any extension of time unless such changes adversely affect the time schedule.

The Associate shall not proceed with the changes as requested till adjustment of contract price and time schedule where so applicable in terms of or otherwise directed by the TPCODL.

5.0 PRICES/RATES/TAXES

Unless specified elsewhere in the contract document, the prices/rates are inclusive of cost of finished product for which MDCC will be issued by TPCODL, packaging and forwarding charges, freight and transit insurance charges covering loading at Associate's works, transportation to TPCODL store/site & unloading & delivery at TPCODL stores/TPCODL site, cost of documentation including all the relevant test certificates and other supportive documents to be furnished.

The Prices/Rates are inclusive of all taxes, levies, cess and duties, particularly Goods and Services Tax as applicable. All government levy / taxes shall be paid only when the invoice is submitted according to the relevant act.

Doc. Title	GENERAL CONDITIONS OF CONTRACT FOR SUPPLY ORDERS	
Rev. No	0	Page 7 of 43

The prices/rates shall remain firm till actual completion of entire supply of goods/material/equipment as per contract is achieved and shall remain valid till the completion of the contract.

The prices shall remain unchanged irrespective of TPCODL making changes in quantum in all or any of the schedules of items of contract.

5.1 Changes in Statutory Tax Structure

If rate of any or all of the statutory taxes and duties applicable to the contract changes, such changes shall be incorporated by default if the changes occur within the contract execution time and shall be applicable if the contract is executed by the Associate within the Contract Execution Time.

For execution of contracts beyond contract execution time, where the delay is not attributable to TPCODL no upward revision in tax /duties shall be considered irrespective of changes in the statutory tax structure either within the contract execution time or beyond. However, in such cases, benefits due to any downward revisions in statutory tax rates shall be passed on to TPCODL.

6.0 TERMS OF PAYMENT

On delivery of the materials in good condition and certification of acceptance by TPCODL official, Associate shall submit the Bills/Invoices in original in the name of "TP Central Odisha Distribution Limited" to invoice desk, complete with all required documents as under:

- Test Reports (4 sets).
- MDCC issued by TPCODL.
- Packing List.
- Drawing and Catalogue.
- Guarantee/Warrantee Card.
- Delivery Challan.
- O&M Manual.
- Copy of Order.
- Minutes of Meeting.

Bills/ invoices shall mention Supplier's GST Number. TPCODL will make 100% payment within 30 days of submission of the Bill/Invoice complete in all respects and along with all the requisite documents mentioned above, subject to condition that Associate has furnished the requisite Security-cum-Performance Guarantee as stipulated in the contract.

6.1 Quantity Variation

Payment will be made on the basis of actual quantity of supplies/actual measurement of works accepted by TPCODL and not on the basis of contract quantity.

6.2 Full and Final Payment

Doc. Title	GENERAL CONDITIONS OF CONTRACT FOR SUPPLY ORDERS	
Rev. No	0	Page 8 of 43

Full & Final Payment in all contracts shall be made subject to the associate submitting “No Demand Certificate” in the format as per Annexure-C.

7.0 MODE OF PAYMENT

Payment shall be made through crossed Cheque or RTGS whichever of the two modes chosen by the Associate, in favour of Associate’s Bank Account on TPCODL records, on whose name Contract has been issued. Those Associates opting for the RTGS mode shall submit the details of Bank Account and other details as per annexure G. Further, for any payments made, TPCODL is not responsible for any consequences/disputes Associate have among the owners channel partners, sub-Associates and all such dispute/concerns shall be settled solely by the Associate.

8.0 SECURITY CUM PERFORMANCE DEPOSIT

Associates shall submit within 15 days from the effective date of issue of PO/RC, Security Performance Bank Guarantee (SPBG) in the format as per Annexure B of this document from banks acceptable to TPCODL for:

- (a) 5% of the PO value if purchase order value is more than Rs 5 Crores.
- (b) 10% of the PO value if purchase order value is less than Rs 5 Crores.

This shall remain valid till the end of the Guarantee Period of contract, plus one month.

- (c) 5% of the RC value in case of Rate Contract. This shall remain valid till the Guarantee period plus one month.

- For PO/RC values less than Rs. 5 lacs, Associate may request for deduction of amount equivalent to SPBG value from their first invoice. Such amount shall be withheld by TPCODL while processing the invoice and shall be released after completion of Guarantee Period plus one month.
- For PO/RC values less than Rs. 3 lacs, the clause (8.0) for Security cum Performance Bank Guarantee (SPBG) shall not be applicable.
- In case of RC (Rate Contract) after the expiry of RC validity, Associate shall have to submit SPBG. However, the Associate has the option to re-submit the SPBG as per actual RO (Release Order) value issued against the RC, valid for Guarantee Period plus one month. The Guarantee Period shall be considered as per the last RO issued against the said RC. The original SPBG as submitted against the RC shall be released on submission of the new SPBG to TPCODL. Alternatively, Associate may extend the validity of original SPBG only till the requisite period, i.e. Guarantee Period plus one month.

9.0 STATUTORY COMPLIANCE

9.1 Compliance to Various Acts

Associate should ensure adherence to all applicable laws, rules and regulation applicable under this contract from time to time. In case of violation any risk, costs etc shall be in associates account and keep TDPPL indemnified always till completion of contracts.

Doc. Title	GENERAL CONDITIONS OF CONTRACT FOR SUPPLY ORDERS	
Rev. No	0	Page 9 of 43

9.2 SA 8000

TPCODL expects its Associates to follow guidelines of SA 8000:2014 on the following aspects

1. Child Labour
2. Forced or Compulsory Labour
3. Health & Safety
4. Freedom of Association & Right to Collective Bargaining
5. Discrimination
6. Disciplinary Practices
7. Working Hours
8. Remuneration
9. Management System

9.3 Affirmative Action

TPCODL appreciate and welcome the engagement/employment of persons from SC/ST community or any other deprived section of society by their business associates.

Relaxation in Contract Clauses under Affirmative Action for SC/ ST Business Associates**

TPCODL believes that inclusive growth is the key to sustainable development, and to promote the same Policy on Affirmative Action for Scheduled Caste & Scheduled Tribe Communities has been adopted across the company.

Under the same pre-text, and to promote entrepreneurship among SC/ST community TPCODL has taken initiative by proposing relaxations in contract clauses as per below:

S. No	Initiative	for SC/ ST BA's	Guideline Document
1	Tender Fees	100% waiver for SC/ST community	All Open Tenders
2	Earnest Money Deposit	50 % relaxation of estimated EMD value	All limited and Open Tenders
3	Performance Bank Guarantee	50% relaxation in PBG for order value above 50 lacs else 25% relaxation	All limited and Open tenders
4	Turnover	25% relaxation in company turnover under qualifying requirement criteria	All Open Tenders

**Classification of BAs under SC/ST shall be governed under following guidelines:

- Proprietorship/ Single Ownership Firm: Proprietor of the firm should be from SC/ST community. Governing document shall be duly audited balance Sheet for the last FY bearing the name of proprietor.
- Partnership Firm: Only such firms shall qualify which have SC/ST partners holding equal to or more than 50% of the total ownership pattern of the firm. Governing document shall be Partnership Deed and audited balance sheet/ ITR for last FY.
- Private limited company: Only such firms shall qualify which have SC/ST directors holding equal to or more than 50% of the total ownership pattern of the firm. Governing document shall be Memorandum of Understanding (MoU) and/or Article of Association (AoA).

Doc. Title	GENERAL CONDITIONS OF CONTRACT FOR SUPPLY ORDERS	
Rev. No	0	Page 10 of 43

Governing document shall be Memorandum of Understanding (MoU) and/or Article of Association (AoA).

Note: Certification from SC/ST commission shall be required for deciding upon SC/ST status of a person.

10.0 QUALITY

10.1 Knowledge of Requirements

The Associate shall be deemed to have carefully examined and to have knowledge of the equipment, the general and other conditions, specifications, schedules, drawings, etc. forming part of the Contract and also to have satisfied himself as to the nature and character of the work to be executed and the type of the equipment and duties required including wherever necessary of the site conditions and relevant matters and details. Any information thus procured or otherwise obtained from TPCODL/Consultants shall not in any way relieve the Associate from his responsibility and executing the works in accordance with the terms of contract.

10.2 Material/Equipment/Works Quality

The items / works under the scope of the Associate shall be of the best quality and workmanship according to the latest engineering practice and shall be manufactured from materials of best quality considering strength and durability for their best performance and, in any case, in accordance with the specifications set forth in this Contract. All material shall be new. Substitution of specified material or variation from the process of fabrication/ construction/ manufacture may be permitted but only with the prior written approval of the TPCODL.

10.3 Adherence to Rules & Regulations

The Associate shall procure and/or fabricate/erect all materials and equipment in accordance with all requirements of Central and State enactment, rules and regulations governing such work in India and at site. This shall not be construed as relieving the Associate from complying with any requirement of TPCODL as enumerated in the Contract which may be more rigid than and not contrary to the above mentioned rules, nor providing such construction as may be required by the above mentioned rules and regulations. In case of variance of the Technical Specification from the laws, ordinance, rules and regulations governing the work, the Associate shall immediately notify the same to the TPCODL. It is the sole responsibility of the Associate, however, to determine that such variance exists. Wherever required by rules and regulations, the Associate shall also obtain the statutory authorities' approval for the plant, machinery and equipment to be supplied by the Associate.

10.4 Specifications and Standards

The Associate shall follow all codes and standards referred in the Contract Document. Codes and standards of other may be followed by the Associate with the prior written approval of TPCODL, provided materials, supplies and equipment according to the standard are equal to or better than the corresponding standards specified in the Contract.

Brand names mentioned in the Contract documents are for the purpose of establishing the type and quality of products to be used. The Associate shall not change the brand name and qualities of the bought out items without the prior written approval of the TPCODL. All such products and equipment shall be used or installed in strict accordance with original manufacturer's recommendations, unless otherwise directed by the TPCODL. In any circumstances the codes, specimen and standards prescribed by any government agency should not be violated.

Doc. Title	GENERAL CONDITIONS OF CONTRACT FOR SUPPLY ORDERS	
Rev. No	0	Page 11 of 43

11.0 INSPECTION/PARTICIPATION

11.1 Right to Carry Out Inspection

TPCODL reserves the right to send its representatives for inspection or participation at various stages of contract execution listed below, applicable as per contract construction.

- During basic design and detail engineering of material/ Equipment carried out by Associate /Outsourced Agencies.
- During manufacturing stages of the product at Associate's/Associate's Outsourced Agency's Plant/Facility.
- During Pre-dispatch Inspection and Testing of finished/manufactured product at Associate's/Associate's outsourced Agency's Plant/Facility.
- During Installation & Commissioning Activities/Stages.
- Prior to Clearing of the completed installation for commissioning.
- Any other stage as find appropriate by TPCODL during contract execution time.

All inspections and participations shall be carried out by TPCODL giving written intimation to the Associate or receiving appropriate advance written inspection call from the Associate, unless otherwise specified elsewhere in the contract document.

11.2 Facilitating Inspection

The Associate shall provide all opportunities and information to TPCODL's engineers to get acquainted with the technical know-how and the methods and practices adopted by the Associate in basic and detail engineering. The Associate shall provide documents, drawings, calculations etc. as may be required by TPCODL's Engineers.

The Associate shall provide free of charge office accommodation, office facilities, secretarial services, communication facilities, general and drawing office stationary, etc. as may be reasonably required by the TPCODL's engineers. Similarly, facilities shall also be provided by Associate's outsource agencies/partners/authorized dealers (collectively termed as sub associates) if such basic and detail engineering activities are carried out in the design offices of sub-Associates.

The Associate shall be responsible for the safety of employees of TPCODL/Third Party Agency when they are at the Associate's /Associate's outsource agency's plant or facility for carrying out/witnessing inspection/testing. All statutory safety precautions as applicable shall be followed by the Associate during Inspection Testing. If TPCODL inspectors are not satisfied with the safety arrangements at the plant, TPCODL have the right to call off inspection till such time corrective action is taken by the Associate.

Before raising the call for pre-dispatch final inspection and testing, the Associate shall conduct all the tests—type tests, routine tests etc-as specified in the contract document and submit copies of the test certificates to TPCODL along with the inspection call, for scrutiny of TPCODL.

The Associate and TPCODL shall jointly document all the observations, comments and action points after completion of inspection and it shall be binding on the Associate to provide compliance on all the points requiring compliance and furnish the compliance report to the designated authority of TPCODL for receiving clearance for dispatch of materials

Doc. Title	GENERAL CONDITIONS OF CONTRACT FOR SUPPLY ORDERS	
Rev. No	0	Page 12 of 43

11.3 Third Party Nomination

TPCODL also may nominate a third party for the purpose of carrying out the inspection and such an agency shall be entitled to all the rights and privileges of TPCODL as far as conducting the inspection.

11.4 Waiver of Inspections

TPCODL on its own discretion shall chose to waive off any inspection and ask the Associate to submit all the test reports as applicable as per contract specifications, related to inspection and testing of the goods ordered for scrutiny and clearance for dispatch.

11.5 Incorrect Inspection Call

In case it is observed that the material offered for inspection is not ready at the time of TPCODL inspection visit rendering it as futile, all costs towards such inspection shall be recovered from the BA. Taxes as applicable on such recoveries shall be borne by the BA.

12.0 MDCC & DELIVERY OF MATERIALS

12.1 Material Dispatch Clearance Certificate

Associate shall deliver material/goods/equipment against Supply Contracts or Supply Part of Composite/Service Contracts only after receiving Material Dispatch Clearance Certificate (hereafter termed as MDCC) issued by designated authority of TPCODL. Material delivered at TPCODL stores or at project site without a valid MDCC issued by the designated official of TPCODL shall be rejected. MDCC shall be issued to associate furnishing compliance report on the action points documented during pre-dispatch inspection and testing at Associate's/ Sub Associate's plant/ facility. In case Pre-dispatch inspection is waived at the discretion of TPCODL, then, MDCC shall be issued on receiving all the test reports-routine& type-from the Associate and finding them in order.

The associate shall include and provide for securely protecting and packing the materials so as to avoid loss or damage during handling and transport by air, sea, rail and road or any other means.

All such packing shall allow to the extent possible for easy removal and checking at Site. The associate shall take special precautions to prevent rusting of steel and iron parts during transit by sea. Gas seals or other materials shall be utilized by the associate for protection against moisture during transit of all Plant and Equipment.

Each Equipment or parts of Equipment shall be tagged with reference to the assembly drawings and corresponding part numbers. Each bale or package shall contain a packing note quoting specifically the name of the associate, item description, quantity, item / package identification.

All packing cases, containers, packing and other similar materials shall be new and supplied free by the associate and it shall not be required to be returned to the associate.

Notwithstanding anything stated in this clause, the associate shall be entirely responsible for loss, damage or depreciation or deterioration to the materials and supplies due to faulty and/or insecure packing or otherwise during transportation to the Site until otherwise provided herein.

In case of the consignments dispatched by road, the associate shall ensure that it or its subcontractors:

- i) Identify and obtain the correct type of trucks/trailers, keeping in view the nature of consignments to be dispatched.

ii) Take such actions as may be necessary to avoid all possible chances of damages during transit and to ensure that all packages are firmly secured.

Timelines for inspection and MDCC is as below:

S. No.	Inspection	MDCC issuance time including Inspection time (max.)
1	Outside Bhubaneswar	12 days
2	Within Bhubaneswar	5 days
3	Waiver*	3 working days

* Associate is expected to raise the inspection call assuming that Inspection shall be carried out by TPCODL. The decision for waiver of inspection shall be on sole discretion of TPCODL.

12.2 Right to Rejection on Receipt

Goods/Material/Equipment delivered in condition physically damaged & incomplete as a product ordered, or not packed and transported as per the terms and conditions of the contract is liable to be rejected. Such item shall be lifted back by Associates within 15 days from receipt of rejection note from TPCODL and have to supply back the material within next 30 days or within the timeframe mutually decided by Associate and TPCODL.

If delivery of the material is beyond the agreed time, Liquidated damage clause, mentioned in this GCC separately shall be applicable; but the period for levy of LD shall be considered as per the original delivery schedule and not from the agreed timelines for material rectification.

12.3 Consignee

Unless otherwise specified in the Contract Document, Materials/Goods/Equipment shall be consigned to "Stores-In-Charge", TPCODL, Bhubaneswar.

12.4 Submission of mandatory documents on Delivery

Following documents shall be mandatorily submitted by BA along with supply of material to TPCODL stores/site:

S. No.	Documents	Requisite
1	Invoice copy in original	With all consignments
2	LR copy	Wherever required
3	Packing list	With all consignments
4	MDCC	With all consignments
5	Purchase order / Release order	Signed copy
6	Test certificates	With all consignments
7	Inspection/JVR report	In case pre-dispatch inspection is conducted
8	Device data in CD as per template for metering items	Wherever applicable

12.5 Dispatch and Delivery Instructions

S. No.	Instructions
1	Purchase order/ Release order no. shall be mentioned on invoice and on material

Doc. Title	GENERAL CONDITIONS OF CONTRACT FOR SUPPLY ORDERS	
Rev. No	0	Page 14 of 43

2	TPCODL material code and material description shall be mentioned in invoice and on material.
3	“Property of TPCODL” shall be embossed on material.
4	The material shall be properly sealed and packed in standard packing as per purchase order terms & conditions.
5	The weight and quantity of material shall be mentioned wherever applicable
6	The material supplied shall be co-related with the packing list.
7	The name plate detail on equipment shall include Material code, Material description, specification detail of material [as applicable], Serial No. Year of manufacturing, PO/RO no. and date, “PROPERTY OF TPCODL, Bhubaneswar”, Guarantee period and Associate’s name.
8	In case of manual unloading, supplier / transporter shall deploy sufficient Labour for unloading the material at TPCODL central store. For heavy item(s), crane will be provided by TPCODL [unloading cost will be recovered from the associate].
9	The driver should have valid License and one helper in truck. All the documents of truck like registration papers, PUC etc. should be available in Truck.
10	BA representative should accompany the material and get it unloaded / stacked in his presence wherever possible.

13.0 GUARANTEE

13.1 Guarantee of Performance

Associates shall stand guarantee that the equipment and material supplied under the contract is free from design, manufacturing, material, construction, erection & installation and workmanship & quality defects and is capable of its due, rated and intended quality performance, as an integrated product delivered under the contract, for a specific period termed as Guarantee Period(as elaborated elsewhere in this clause). The Associate should also guarantee that the equipment/material is new and unused except for the usage required for the tests and checks required as part of quality assurance.

13.2 Guarantee Period

The Guarantee Period will be equipment/service/work specific and shall be as specified in the Standard Specifications of TPCODL for the equipment/material/service/work and where standard specifications are not part of contract documents or guarantee period is not specified in the standard specifications,, the guarantee period shall be as per the Special Terms and Conditions of the Contract. In case of no mention of the guarantee period in standard specifications or SCC Guarantee Period will be 12 Months from the Date of Commissioning or 24 months from the date of delivery of final lot of supplies made, whichever is earlier.

13.3 Failure in Guarantee Period (GP)

If the equipment and material supplied under the contract fails to perform its due, rated & intended quality performance, during the Guarantee period, the associate is liable to undertake repair/rectify/replace the equipment and material supplied within time frame specified in the SCC or elsewhere in the contract documents at associate’s cost to make the equipment and material supplied/service or work rendered under the contract of performing its due, rated and intended quality performance. If Associate fails to repair/rectify/replace the equipment or material supplied rendered under the contract, failed in Guarantee Period, TPCODL will be at liberty to get the same done at Associate’s risks and costs and recover all such expenses plus the TPCODL’s own

Doc. Title	GENERAL CONDITIONS OF CONTRACT FOR SUPPLY ORDERS	
Rev. No	0	Page 15 of 43

charges (@ 20% of expenses incurred), from the Associate or from the "Security cum Performance Deposit" as the case may be.

If during the Warranty/ Guarantee period some parts of the supplies are replaced owing to the defects/ damages under the Warranty, the Warranty period for such replaced parts shall be until the expiry of twelve months from the date of such replacement or renewal or until the end of original Guarantee period, whichever is later.

Any repairs during the Guarantee Period shall be carried out by the Associate within 30 days of reporting the issue to Associate by TPCODL. However, if replacement of the Equipment is required, Associate shall notify the same to TPCODL within 7 days of reporting the issue by TPCODL. Thereafter, the total time for supply of new equipment/ material shall be equal to the original delivery period of that equipment/ material as specified in the Contract. In case the Associate is not able to rectify/ replace the faulty equipment/ material within the stipulated timelines as mentioned above, penalty shall be levied as per the Liquidated Damages clause mentioned in this document. The penalty amount shall be recovered from the payment due to the vendor or by encashment of the SPBG as the case may be.

13.4 Cost of repairs on failure in GP

The cost of repairs/rectification/replacement, required transportation, site inspection /mobilization/dismantling and re-installation costs as applicable, to be borne by Associate. The Associate has to ensure that the interruption in the usage of intended purpose of the equipment is minimized to the maximum extent In lieu of the time taken for repairs/rectification/replacement.

13.5 Guarantee period for Goods Outsourced

If the Associate outsources partly equipment/materials/services from third party as mutually agreed upon at the pre award stage of contract, TPCODL shall have the benefit of any additional guarantee period if provided by the third party for the part supplied/executed by them.

13.6 Latent Defect

Hidden defects in manufacturing or design of the product supplied and which could not be identified by the tests conducted but later manifested during operation of the equipment are termed as latent defects. Associates shall further be responsible for 'free replacement' for another period of THREE years from the end of the guarantee period for any 'Latent Defects' if noticed and reported by the Company.

13.7 Support beyond the Guarantee Period

The Associate shall ensure availability of spares and necessary support for a period of atleast 10 years post completion of guarantee period of equipment supplied against the contract.

14.0 LIQUIDATED DAMAGES

- a) For supplies which are of standalone use, multiple in quantities and having a single final delivery schedule, Liquidated damages shall be levied without prejudice to any of the other contractual rights of TPCODL, as described below:

For delay of each week and part thereof from the delivery schedule specified in the contract, 1% of contract value corresponding to undelivered quantity, provided full quantity is supplied within 130% of the original contract time. If full contractual quantity is not delivered within 130% of contract time for delivery, TPCODL has the right to levy LD on the entire contract value, subject to a maximum of 10% of the total contract value.

Doc. Title	GENERAL CONDITIONS OF CONTRACT FOR SUPPLY ORDERS	
Rev. No	0	Page 16 of 43

- b) For Supplies having phased delivery schedule as per contract terms, standalone use and multiple in quantities, Liquidated damages shall be levied without prejudice to any of the other contractual rights of TPCODL, as described below:

For the purpose of calculating and applying LD, each delivery lot shall be considered separately. For delay of each week and part thereof, from the delivery schedule specified for the lot, 1% of the contract value corresponding to the undelivered quantity of the lot subject to a maximum of 10% of the total contract value of the subject lot. However, if full contractual quantity is not delivered within 130% of contract time for delivery, TPCODL has the right to levy LD on the entire contract value, subject to a maximum of 10% of the total contract value. Deduction of LD shall be on landed cost i.e contract value inclusive of taxes and in pursuant statutory compliance GST would be applicable at the stipulated rate and the same shall be borne by Business Associate. In case of LD deduction, a GST invoice shall be issued by TPCODL as a proof of deduction/recovery.

14.1 LD Waiver Request

Any request of LD waiver shall be submitted within thirty (30) days of deducting LD. Request submitted beyond the timeline shall not be entertained.

15.0 UNLAWFUL ACTIVITIES

The Associate shall have to ensure that none of its employees are engaged in any unlawful activities (whether covered under the scope of the present GCC or not) subversive of the TPCODL's interest failing which appropriate action (legal or otherwise) may be taken against the Associate by the TPCODL, in accordance with the terms of the present GCC.

16.0 CONFIDENTIALITY

Associate and its employees or representatives thereof shall strictly maintain the confidentiality of various information they come across while executing the contract as detailed below.

16.1 Documents

All maps, plans, drawings, specifications, schemes and other documents or information related to the Contract/Project and the subject matter contained therein and all other information given to the Associate by the TPCODL in connection with the performance of the contract shall be held confidential by the Associate and shall remain the property of the TPCODL and shall not be used or disclosed to third parties by the Associate for any purpose other than for which they have been supplied or prepared. The Associate may disclose to third parties, upon execution of confidentiality agreements, such part of the drawings, specifications or information if such disclosure is necessary for the performance of the Work provided such third parties agree in writing to keep such information confidential to the same extent and degree as provided herein, for the benefit of the TPCODL.

16.2 Geographical Data

Maps, layouts and photographs of the unit/plant including its surrounding regions showing vital installation for national security of country or those of TPCODL shall not be published or disclosed to the third parties or taken out of the country without prior written approval of the TPCODL and upon execution of confidentiality agreements satisfactory to the TPCODL with such third parties prior to disclosure.

Doc. Title	GENERAL CONDITIONS OF CONTRACT FOR SUPPLY ORDERS	
Rev. No	0	Page 17 of 43

16.3 Associate's Processes

Title to secret processes if any developed by the Associate on an exclusive basis and employed in the design of the equipment shall remain with the Associate. TPCODL shall hold in confidence such processes and shall not disclose such processes to the third parties without prior approval of the Associate and execution by such third parties of secrecy agreements satisfactory to the Associate prior to disclosure. Upon completion of contract, such processes shall become the property of the TPCODL. Title to technical specifications, drawings, flow sheets, norms, calculations, diagrams, interpretations of test results, schematics, layouts and such other information, which the Associate has supplied to the TPCODL under the Contract shall be passed on to the TPCODL. The TPCODL shall have the right to use these for construction, erection, start-up, Trial Run, operation, maintenance, modifications and/or expansion of the works including for the manufacture of spare parts.

16.4 Exclusions

The provision of Clauses 16.1 to 16.3 shall not apply to information:

- Which at the time of disclosure are in the public domain which later on become part of public domain through no fault of the party concerned, or
- Which were in the possession of the party concerned prior to disclosure to him by the other party, or
- Which were received by the party concerned after the time of disclosure without restriction on disclosure or use, from a third party who did not acquire such information directly or indirectly from the other party or has no obligation of confidentiality for such information.

16.5 Violation

In case of violation of this clause, the Associate is liable to pay compensation and damages as may be determined by the competent authority of TPCODL.

17.0 INTELLECTUAL PROPERTY RIGHTS

If, in the course of performance of its functions and duties as envisaged by the scope of the present GCC, the Associate acquires or develops, any unique knowledge or information which would be covered, or, is likely to be covered within the definition of a trademark, copyright, patent, business secret, geographical indication or any other form of intellectual property right, it shall be obliged, under the terms of this present GCC, to share such knowledge or information with the TPCODL. All rights, with respect to, or arising from such intellectual property, as afore mentioned, shall solely vest in TPCODL.

Moreover, the Associate undertakes not to breach any intellectual property right vesting in a third party/parties, whether by breach of statutory provision, passing off, or otherwise. In the event of any such breach, the Associate shall be wholly liable to compensate, indemnify or make good any loss suffered by such third party/parties, or any compensation/damages arising from any legal proceeding/s, or otherwise. No liability of TPCODL shall arise in this respect, and any costs, damages, expenses, compensation payable by TPCODL in this regard to a third party/parties, arising from a legal proceeding/s or otherwise, shall be recoverable from the Associate.

18.0 INDEMNITY

The Associate shall at all times indemnify, keep indemnified and hold harmless the TPCODL and its officers, directors, employees, affiliates, agents, successors and assigns against all actions, claims, demands, costs, charges and expenses arising from or incurred by reason of any

Doc. Title	GENERAL CONDITIONS OF CONTRACT FOR SUPPLY ORDERS	
Rev. No	0	Page 18 of 43

infringement of patent, trade mark, registered design, copy rights and/or industrial property rights by manufacture, sale or use of the equipment supplied by the Associate whether or not the TPCODL is held liable for by any court judgement. In this connection, the TPCODL shall pass on all claims made against him to the Associate for settlement.

The Associate assumes responsibility for and shall indemnify and save harmless the TPCODL from all liability, claims, costs, expenses, taxes and assessments including penalties, punitive damages, attorney's fees and court costs which are or may be required to be paid by the TPCODL and its officers, directors, employees, affiliates, agents, successors and assigns arising from any breach of the Associate's obligations under the Contract or for which the Associate has assumed responsibilities under the Contract including those imposed under any local or national law or laws, or in respect to all salaries, wages or other compensation for all persons employed by the Associate or his Sub-Associates or suppliers in connection with the performance of any work covered by the Contract. The Associate shall execute, deliver and shall cause his Sub-Associate and suppliers to execute and deliver, such other further instruments and to comply with all the requirements of such laws and regulation as may be necessary there under to conform and effectuate the Contract and to protect the TPCODL.

The TPCODL shall not be held responsible for any accident or damages incurred or claims arising, due to the Associate's error there from prior to completion of work. The Associate shall be liable for such accidents and after completion of work for such accidents as the case may be due to negligence on his part to carry out Work in accordance with Indian laws and regulations and the specifications set forth herein.

19.0 LIABILITY & LIMITATIONS

19.1 Liability

Except for any specific liability which may be identified in the Contract and which may be payable hereunder, Associate shall not be liable for any special, incidental, indirect, or consequential Damages or any loss of business Contracts, revenues or other financial loss (or equivalents thereof no matter how claimed, computed or characterized) arising out of or in connection with the Performance of the Work or supply of Goods ***unless caused by Associate's negligence, willful misconduct or breach of contract.***

If the Associate is a joint venture or consortium, all concerned parties shall be jointly and severally bound to the TPCODL for the fulfillment of the provisions of the Contract. The consortium or the joint venture shall designate one party as their leader, who will be the coordinator between the parties and TPCODL. The constituents & leader of the consortium or joint venture shall not be changed without the prior consent of TPCODL.

TPCODL shall have no liability or any special, incidental, indirect or consequential Damages for any loss of Business Contracts, revenues or other financial loss arising out of this Contract.

19.2 Limitation of Liability

The total liability of Associate against any contract shall be limited to the Total All Inclusive Contract Value.

20.0 FORCE MAJEURE

Force Majeure applies if the performance by either Party ("the Affected Party") of its obligations under Contract is materially and adversely affected.

"Force Majeure" shall mean any event or circumstance or combination of events or circumstances referred below and their consequences that wholly or partly prevents or unavoidably delays any

Doc. Title	GENERAL CONDITIONS OF CONTRACT FOR SUPPLY ORDERS	
Rev. No	0	Page 19 of 43

Party in the performance of its obligations under this Agreement, but only and to the extent that such events and circumstances are not within the reasonable control, directly or indirectly, of the Affected Party and could not have been avoided even if the Affected Party had taken reasonable care:

- Act of war (whether declared or undeclared), invasion, armed conflict or act of foreign enemy, embargo, blockade, revolution, riot, bombs, religious strife or civil commotion, etc. ▪ Politically motivated sabotage, or terrorism, etc.
- Action or Act of Government or Governmental agency for which remedy is beyond the control of the affected parties. ▪ Any act of God.

Note: Causes like power breakdown/ shortages/fire/strikes, accidents etc do not fall under Force Majeure.

Time being the essence of the Contract, if either party is prevented from the performance of its obligations in whole or in part due to an event of Force Majeure, then provided Notice of happening of any event by the Affected Party is given to the other party within seven (7) days from the date of occurrence of such event, which DIRECTLY has impact on works and submitted details and quantum of resulting effect, but at the same time had made all possible efforts to mitigate and overcome effects thereof, the Affected Party's performance under this Contract shall be suspended until such event ceases and the Scheduled Completion shall be delayed accordingly.

If Force Majeure event(s) continue for a period of more than three months, the parties shall hold consultation to discuss the further course of action.

Neither party shall be considered to be in default or in breach of its obligation under the Contract to the extent that performance of such obligation by either party is prevented by any circumstances of Force Majeure which arise after effective date of Contract.

Neither party can claim any compensation from the other party on account of Force Majeure.

21.0 SUSPENSION OF CONTRACT

21.1 Suspension for Convenience

TPCODL may, at any time and at its sole option, suspend execution of all or any portions of the schedule of items of contract to be supplied/work to be executed by Associate under the contract by providing to the Associate at least two business days written notice for contracts having contract completion period less than sixty days and at least seven business days' notice for all other contracts.

Upon receipt of any such notice, the Associate shall respond as follows as applicable as per contract construction.

- Immediately discontinue further supply of material/goods specified in the suspension notice for supply contracts
- Immediately discontinue further service/work and supply of materials of those services/materials/work specified in the suspension notice for service /composite contract
- Promptly make every reasonable effort to obtain suspension, upon terms satisfactory to TPCODL, of all orders, outsourcing arrangements, and rental Contracts to the extent that they relate to performance of the portion of Work suspended by the notice.

Doc. Title	GENERAL CONDITIONS OF CONTRACT FOR SUPPLY ORDERS	
Rev. No	0	Page 20 of 43

- Protect and maintain the portion of the service/Work already completed, including the portion of the Work suspended hereunder, unless otherwise specifically stated in the notice.
- Continue delivering/carrying out the supply/service/work items as per contract conditions, which do not fall under purview of the suspension notice.

On receipt of resumption notice from TPCODL, the Associate shall resume execution of contract as specified in the resumption notice, within the time frame specified in the resumption notice.

21.2 Suspension for Breach of Contract conditions.

TPCODL shall suspend execution of whole/or part thereof the contract till such time Associate complies with the conditions stipulated under section clause 22.1 for breach/default of contract conditions.

21.3 Compensation in lieu of Suspension

If the suspension of the contract in whole or in part is for convenience of TPCODL and not due to any breach of contract conditions by the associate, TPCODL at its discretion shall consider compensating all reasonable additional costs incurred by Associate in lieu of suspension of whole or part of contract, on representation of the Associate providing justified estimates of such additional costs and such estimates are found acceptable and approved by competent authority of TPCODL.

If the suspension of contract in whole or part thereof is due to breach of contract conditions (refer clause 22.1) by the Associate, Associate shall not be entitled for any compensation for any cost incurred in lieu of suspension of whole or part of contract and also shall be liable for compensating all the losses arising to TPCODL in lieu of suspension of contract. Resumption notice shall be subject to the Associate taking corrective action for the breach of contract conditions within the time frame and as per the terms specified in the suspension notice.

22 TERMINATION OF CONTRACT

22.1 Termination for Default/Breach of Contract

The contract / PO /RC shall be subject to termination by TPCODL in case of breach of the contract by the Associate which shall include but not be limited to the following:

- a. Withdrawal or intimation by the Associate of its intent to withdraw or surrender the execution / completion of the contracted work /PO or failure in ensuring adherence to any delivery schedules, in deviation of the contract/PO.
- b. Refusal or neglect on the part of the Associate to supply material/equipment of quantity or quality as specified by TPCODL and within the timeframe as specified in the contract document or refusal or neglect to execute the services/work in terms of the agreed standards of quantity or quality and/or within the timeframe specified in the contract/PO.
- c. Failure in any respect to perform any portion of the Work contracted with promptness, diligence, or in accordance with the terms of the contract.
- d. Failure to furnish guarantees as specified and /or failure to comply with the terms thereof.
- e. Failure to furnish such relevant documents or information within the time specified which may be necessary for due execution / completion of the works and documentation.

Doc. Title	GENERAL CONDITIONS OF CONTRACT FOR SUPPLY ORDERS	
Rev. No	0	Page 21 of 43

- f. Liquidation, bankruptcy either voluntary or involuntary OR entering into any composition or compromise with its creditors, or Insolvency.
- g. In case any reasonable information has been received by TPCODL that Associate has adopted/ or attempted to adopt any unethical conduct, action in award of the contract /PO or at any time thereafter.
- h. Failure to comply with applicable statutory provisions as contained in the contract or failure to comply with the applicable laws.
- i. Failure to comply with safety regulations/clauses stipulated in the contract or as may be generally instructed by TPCODL.

If the default or breach as specified under clause 22 (except sub clause g thereof) be committed by the associate for the first time, TPCODL shall issue, along the with notice of default or breach, a warning notice instructing the associate to take remedial/corrective action within the time frame stipulated in the warning notice and not to repeat the same in future. The timeframe for corrective action by the associate shall be specific to the nature of breach of contract and the same shall not be objected to by the Associate. If the Associate fails to comply with the instructions in the warning notice or in taking corrective action to the satisfaction of TPCODL then TPCODL may terminate the entire or part of contract at its discretion by issuing termination notice without incurring any liability on this ground.

In case the contract is terminated for any breach of the nature specified in clause 22 g stated above, TPCODL shall have the right to terminate all the contracts TPCODL is having with the Associate by issuing termination notice which shall be without prejudice to the other rights of TPCODL available to it under law.

Without prejudice to its right to terminate for breach of contract, TPCODL may, without assigning any reason, terminate the Contract in whole or in part at any time at its discretion while the contract is in force by serving a written notice of two weeks to the Associate.

In the event of TPCODL having proceeded with termination of the contract the associate shall comply and proceed further in the following manner:

- a) Associate shall discontinue the supply, on the expiry of the said period of two weeks.
- b) Associate shall ensure that no further steps are being taken towards discharge of the obligations, terms and conditions as contained in the contract/PO. This shall include initiation of actions not limited to discontinuation of other allied and associated arrangements which the associate might have entered into with third parties for due discharge of its obligations under the contract with TPCODL.
- c) The Associate shall perform thereafter such tasks as may be necessary to preserve and protect the terminated portion of the material/service/work in progress and the materials and equipment at TPCODL sites or in transit thereto. However the associate shall continue to fulfill its contractual obligations with regard to the part of contract not terminated.
- d) It shall be open for TPCODL to conduct a joint assessment with the associate of the material, supplies, equipment ,works or in general as to the subject matter of the contract in regard to which the associate claims having completed its obligations before or during such termination.

Doc. Title	GENERAL CONDITIONS OF CONTRACT FOR SUPPLY ORDERS	
Rev. No	0	Page 22 of 43

- e) It shall be open to TPCODL to seek invocation of the performance bank guarantee or any other guarantee or other security deposit by whatever name called submitted by the associate, which shall not be objected to or protested against by the associate.

In case of termination of the contract the parties agree to be governed inter alia by the following:

- a) In case TPCODL exercises its right of termination as stated above the associate shall not dispute or object to the same.
- b) The Associate shall be entitled to receive and claim only such payments OR sums of money from TPCODL as may be found payable to it in regard to works executed by it under the terms of the contract and no other claim of any nature whatsoever shall be made by the Associate.
- c) All such provisions which the parties have agreed to survive and prevail even after termination of the contract shall remain effective despite the termination.

In the event of such termination, TPCODL may finish the Work by whatever method it may deem expedient, including the hiring of services and /or purchase of material equipment from such third parties as TPCODL may deem fit or may itself provide any labor or materials and perform any part of the Work. The associate undertakes to bear the incremental costs if any paid by TPCODL in such a case attributable to failure on the part of the associate. The Associate in such a case shall not be entitled to receive any further payments and any sums found payable to it may be adjusted by TPCODL against the amount recoverable from him on this ground. The same shall be without prejudice to other rights available to TPCODL under law against the associate. Upon the termination of any of the contract due to occurrence of any circumstances provided in clauses stated above and constituting repeated breach or misconduct, TPCODL shall be entitled to bar the associates its agents, affiliates from undertaking any negotiation / tendering, bidding, participation activities concerning TPCODL for a period of two years from date of such termination. The same shall be without prejudice to other rights available to TPCODL.

22.2 Termination for Convenience of Associate

Associate at its convenience may request for termination of contract, clearly assigning the reason for such request. TPCODL has full right to accept, reject or partially accept such request. However, associate shall continue its supply as per contract till final approval is given to associates for such termination.

22.3 Termination for Convenience of TPCODL

TPCODL at its sole discretion may terminate the contract by giving 30 days prior notice in writing or through email to the Associate. TPCODL shall pay the Associate for all the supplies/ services rendered till the actual date of contract termination against submission of invoice by the Associate to that effect.

23.0 DISPUTE RESOLUTION & ARBITRATION

In case of any dispute or difference the parties shall endeavour to resolve the same through conciliatory and amicable measures within 15 Days failing which the matter may be referred by either party for resolution by the sole arbitrator to be appointed mutually by both the parties. The arbitral proceedings shall be conducted in accordance with Arbitration and Conciliation Act 1996 and the place of arbitration shall be Bhubaneswar. The language to be used at proceedings shall be English and the award of the arbitrator shall be final and binding on the parties. The parties shall bear their respective costs of arbitration. The associate shall continue to discharge its obligations towards due performance of the works as per the terms of the contract during the

Doc. Title	GENERAL CONDITIONS OF CONTRACT FOR SUPPLY ORDERS	
Rev. No	0	Page 23 of 43

arbitration proceedings unless otherwise directed in writing by TPCODL or suspended by the arbitrator. Further, TPCODL shall continue making such payments as may be found due and payable to the associate for such works.

23.1 Governing Laws and Jurisdiction

The parties shall be subject to the jurisdiction of the courts of law in Bhubaneswar and any matter arising here from shall be subject to applicable law in force in India.

24.0 ATTRIBUTES OF GCC

24.1 Cancellation

The Company reserves the right to cancel, add, delete at its sole discretion, all or any terms of this GCC or any contract, order or terms agreed between the parties in pursuance without assigning any reasons and without any compensation to the Associates.

24.2 Severability

If any portion of this GCC is held to be void, invalid, or otherwise unenforceable, in whole or part, the remaining portions of this GCC shall remain in effect.

24.3 Order of Priority

In case of any discrepancies between the stipulations in General Conditions of the Contract (GCC) and Special Conditions of Contract (SCC), the GCC shall stand superseded by the SCC to the extent stipulated hereinabove while balance portion of respective clauses of GCC shall continue to be applicable.

25.0 ERRORS AND OMISSIONS

The Associate shall be responsible for all discrepancies, errors and omissions in the drawings, documents or other information submitted by him, irrespective of whether these have been approved, reviewed or otherwise accepted by the TPCODL or not. However any error in design/drawing arising out of any incorrect data/written information from TPCODL will not be considered as error and omissions on part of the Associate.

26.0 TRANSFER OF TITLES

The title of ownership and property to all equipment, materials, drawings & documents shall pass to the TPCODL on acceptance of material by store/site after Inspection.

However, such passing of title of ownership and property to the TPCODL shall not in any way absolve, dilute or diminish the responsibility and obligations of the Associate under this Contract including loss or damages and all risks, which shall vest with the Associate.

27.0 INSURANCE

The Contractor shall take out the Insurance Policies which shall cover all risks including the following, as applicable:-

- a) The value of the policy shall cover the total value of all the items till they are handed over to TPCODL.
- b) TPCODL shall be the principal holder of the policy. The Associate shall be the loss payee under the policy. Associate / Sub-contractor of the Associate shall not be holders or beneficiaries in the policy nor shall they be named in the policy. TPCODL reserves the exclusive right to assign the policy.

Doc. Title	GENERAL CONDITIONS OF CONTRACT FOR SUPPLY ORDERS	
Rev. No	0	Page 24 of 43

- c) While the payment of premium may be phased in agreement with the insurance company, at no time shall goods and services required to be provided by the associate shall remain uninsured in accordance with (a) above.
- d) A copy of the Insurance policy shall be made available to TPCODL prior to first dispatch lot of any Equipment and policy shall be kept alive and valid at all times up to the stage of final acceptance.
- e) TPCODL reserves the right to take out whatever policy that is deemed necessary by him if the associate fails to keep the said policy alive and valid at all times and/or causes lapses in payment of premium thereby jeopardizing the said policy. The cost of such policy(s) shall be recovered / deducted from the amount payable to the associate.
- f) The policy shall ensure that the TPCODL's decision regarding replacement of goods damaged, lost or rendered unusable shall be final.

In all cases, the associate shall lodge the claims with the underwriters and also settle the claims and shall also notify TPCODL of any filed claims. However, the associate shall proceed with the repairs and/or replacement of the equipment/components without waiting for the settlement of the claims. In case of seizure of materials by concerned authorities, the associate shall arrange prompt release against bond, security or cash as required. TPCODL, upon request by the associate, will extend all reasonable assistance to the associate in such a case.

All the insurance claims shall be processed and settled by the associate and the missing/damaged items shall be replaced/repared by them without any extra cost to TPCODL and without affecting the completion time.

28.0 SUGGESTIONS & FEEDBACK

We welcome all our Business Associates to write to us about their experience with TPCODL; be it our Company, our services or our people. Each and every concern, issue, query and suggestion from you will help us to become a better company to work with and shall help us develop a strong bonding of trust and a long term relationship with you.

You may send your feedback by filling up our Business Associate Feedback Form enclosed herewith as *Annexure-E*. You can also log on to our website www.tpcentralodisha.com to provide your feedback.

- Suggestions for us
- Feedback form
- Knowledge Sharing/ Experience with TPCODL
- Any issues with TPCODL.

Submission of feedback form is mandatory before the release of final payment to the BA.

29.0 CONTACT POINTS

In case Business Associate needs information with respect to payments or has any grievances, same may be lodged by log on to our website www.tpcentralodisha.com

30.0 LIST OF ANNEXURES

S. No.	Subject	Annexure
--------	---------	----------

Doc. Title	GENERAL CONDITIONS OF CONTRACT FOR SUPPLY ORDERS	
Rev. No	0	Page 25 of 43

1.	Performa for Bid Security Bank Guarantee	A
2.	Performa for Performance Bank Guarantee (CP cum EP)	B
3.	Performa for No Demand Certificate by Associate	C
4.	Performa For Application For Issuance of Consolidated TDS Certificate	D
5.	Business Associate Feedback Form	E
6.	Acceptance Form For Participation In Reverse Auction Event	F
7.	Form for RTGS Payment	G
8.	Vendor Appraisal Form	H
9.	Manufacturer Authorization Form	I

ANNEXURE-A

PROFORMA FOR BID SECURITY BANK GUARANTEE

**The TP Central Odisha Distribution Limited
Bhubaneswar**

WHEREAS, (Name of the Bidder) _____
(hereinafter called "the BIDDER") has submitted his bid dated _____ for the (Name
of Contract) _____ (hereinafter called "the BID").

Doc. Title	GENERAL CONDITIONS OF CONTRACT FOR SUPPLY ORDERS	
Rev. No	0	Page 26 of 43

KNOW ALL men by these presents we (Name of the Bank) _____ of (Name of the Country) _____ having our registered office at _____ (hereinafter called "the BANK) are bound unto The TP Central Odisha Distribution Limited (TPCODL) in the sum of _____ for which payment well and truly to be made to the TPCODL the Bank binds himself, his successors and assigns by these presents.

SEALED with the Common Seal of the said Bank this _____ day of _____ 20_____.

The CONDITIONS of this obligation are:

- i) If the Bidder withdraws his Bid during the period of bid validity specified in the Proforma of Bid or
- ii) If the Bidder having been notified of the acceptance of his Bid by the TPCODL during the period of bid validity fails or refuses to furnish the Contract Performance Bank Guarantee, in accordance with the Instructions to Bidders.

We undertake to pay the TPCODL upto the above amount upon receipt of its first written demand, provided that in its demand the TPCODL will note that amount claimed by it is due to it owing to the occurrence of one or both conditions, specifying the occurred condition or conditions.

This Guarantee will remain in force upto and including the date (No of days as mentioned in tender enquiry) days after the closing date of submission of bids as stated in the Invitation to Bid or as extended by you at any time prior to this date, notice of which extension to the Bank being hereby waived, and any demand in respect thereof should reach the Bank not later than the above date.

DATE **SIGNATURE OF THE BANK**

WITNESS **SEAL**

(Signature, Name & Address) (At least 2 witnesses)

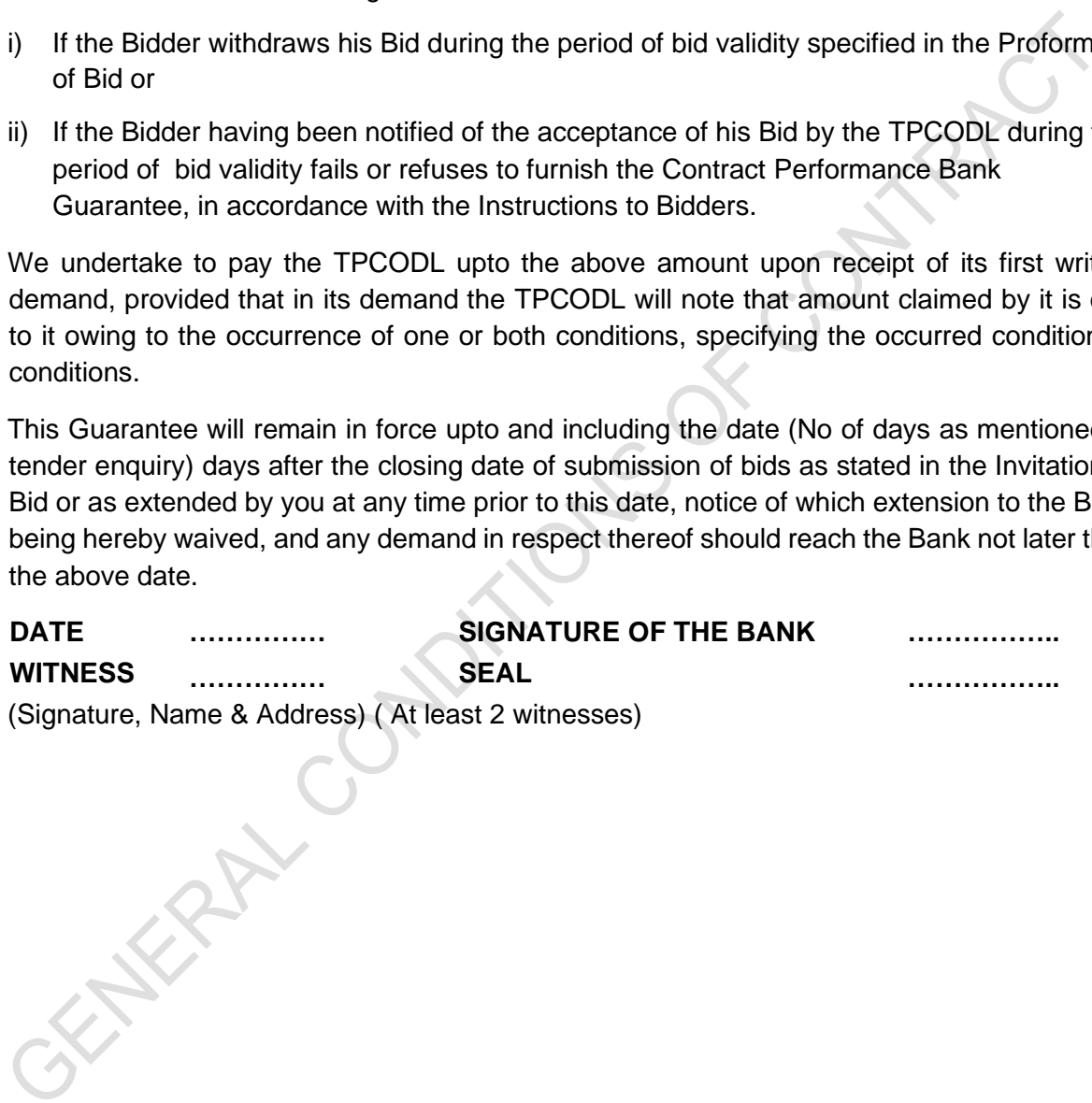

	TP CENTRAL ODISHA DISTRIBUTION LIMITED	
	WORK INSTRUCTION /OPERATING GUIDELINES	
Doc. Title	GENERAL CONDITIONS OF CONTRACT –SUPPLY ORDERS	
Rev. No	0	Page 27 of 43

ANNEXURE- B

PROFORMA FOR PERFORMANCE BANK GUARANTEE (CP cum EP)

(On Rs.100/- Stamp Paper) Note:

- a) Format shall be followed in toto
- b) Claim period of one month must be kept up
- c) The guarantee to be accompanied by the covering letter from the bank confirming the signature to the guarantee

The TP Central Odisha Distribution Limited

Bhubaneswar

CP cum EP BG No.....

Order/Contract No.....dated.....

1. You have entered into a Contract No _____ with M/s. _____ (hereinafter referred to as "the Vendor") for the supply cum erection / civil work of _____ (hereinafter referred to as "the said Equipment") for the price and on the terms and conditions contained in the said contract.
2. In accordance with the terms of the said contract, "the Vendor" agreed to furnish you with an irrevocable, unconditional and acceptable bank guarantee for 10% of the value of contract and to be valid till the end of Guarantee period plus one month towards "Contract cum Equipment performance". For this purpose you have agreed to accept the guarantee.
3. In consideration thereof, we, _____ hereby irrevocably and unconditionally guarantee to pay to you on demand but in any case before the end of five working days from the date of the claim and without demur and without reference to "the Vendor" such amount or amounts not exceeding the sum of Rs. _____ (Rupees _____ only) being _____% (_____ percent) of the total value of the contract on receipt of your intimating that "the Vendor" has not fulfilled his contractual obligations. You shall be the sole judge for such non-fulfillment and "the Vendor" shall have no right to question such judgment.
4. You shall have the right to file / make your claim on us under the guarantee for a **further period of one month** from the date of expiry.
5. This guarantee shall not be revoked without express consent and shall not be affected by your granting time or any other indulgence to "the Vendor", which shall include but not be limited to, postponement from time to time of the exercise the same in you or any right which you may have against "the Vendor" and to exercise the same in any covenant contained or implied in the said contract or any other course or remedy or security available to you, and our Bank shall not be released from its obligations under this guarantee by

Doc. Title	GENERAL CONDITIONS OF CONTRACT FOR SUPPLY ORDERS	
Rev. No	0	Page 28 of 43

your exercising any of your rights with reference to matters aforesaid or any of them or by reasons of any other act or forbearance or other acts of omission or commission on your part or any other indulgence shown by you or by any other matter or thing whatsoever which under the law would, but for this provision have the effect of relieving our bank from its obligation under this guarantee.

6. We also agree that you shall be entitled at your option to enforce this guarantee against our bank as a principal debtor, in the first instance, notwithstanding any other security or guarantee that you may have in relation to "the Vendor's" liabilities in respect of the premises
7. This guarantee shall not be affected by any change in the constitution of our Bank or "the Vendor" or for any other reason whatsoever.
8. Any claim / extension under the guarantee can be lodge-able at outstation banks or at Bhubaneswar branch and claim will also be payable at Bhubaneswar Branch (to be confirmed by Bhubaneswar Branch by a letter to that effect in case BG is from the branch outside Bhubaneswar).
9. Notwithstanding anything herein contained, our liability under this guarantee is limited to Rs. _____ (Rupees _____) only and the guarantee will remain in force upto and including _____ (Date) and shall be extended from time to time for such period or period as may be desired by "the Vendor".
10. Unless a demand or claim under this guarantee is received by us in writing within one months from _____ (expiry date) i.e. on or before _____ (claim period end date), we shall be discharged from all liabilities under this guarantee thereafter.

Dated at _____ this _____ day of _____ 20__

Bank's rubber stamp

1. Banks full address
Designation of Signatory
2. Bank official number

Doc. Title	GENERAL CONDITIONS OF CONTRACT FOR SUPPLY ORDERS	
Rev. No	0	Page 29 of 43

ANNEXURE-C

PROFORMA FOR “NO DEMAND CERTIFICATE” BY ASSOCIATE

(On Company's Letter head or with Company Seal)

(To be submitted by the Associate to TPCODL Accounts Department at the time of receipt of full and final payment)

(Certificate No. CCP/002)

Name of the Project Order/

Contract No.

Dated

Name of the Associate Scheme

No. / Job No.

We, M/s. _____ (Associate) do hereby acknowledge and confirm that we have received the full and final payment due and payable to us from TPCODL, in respect of our aforesaid Order No _____ dated _____ including amendments, if any, issued by TPCODL to our entire satisfaction and we further confirm that we have no claim whatsoever pending with TPCODL under the said contract / W.O.

Notwithstanding any protest recorded by us in any correspondence, documents, measurement books and / or final bills etc., we waive all our rights to lodge any claim or protest in future under this contract.

We are issuing this “NO DEMAND CERTIFICATE” in favour of TPCODL, with full knowledge and with our free consent without any undue influence, misrepresentation, coercion etc.

Place

Name

(Company Seal)

Doc. Title	GENERAL CONDITIONS OF CONTRACT FOR SUPPLY ORDERS	
Rev. No	0	Page 30 of 43

ANNEXURE-D

**PROFORMA FOR APPLICATION FOR ISSUANCE OF CONSOLIDATED TDS
CERTIFICATE**

To be printed on the letterhead

To,

The TP Central Odisha Distribution Limited,

Bhubaneswar

Sub: Application for issuance of Consolidated TDS Certificate for the FY _____

Dear Sir,

I / we hereby request / authorize you to issue me / us a consolidate TDS Certificate for the financial year _____ against tax deducted at source by you from my / our payments / bills during the said year from time to time under Chapter XVII – B of the Income Tax Act, 1961. For and on behalf of

Signature

Name

Address

Contact No. (Land Line)

(Mobile)

PAN #

Assessing authority

ATTACH THE COPY OF PAN CARD

Doc. Title	GENERAL CONDITIONS OF CONTRACT FOR SUPPLY ORDERS	
Rev. No	0	Page 31 of 43

ANNEXURE-E

BUSINESS ASSOCIATE FEEDBACK FORM

With an objective to improve our internal processes and systems, and serve you better, we solicit your valuable feedback & suggestions. It is estimated that it will take about 10 minutes to complete this survey. We assure you that your feedback shall be kept confidential. Please send the duly filled feedback form in the "TPCODL addressed - attached envelop"

You are associated with us as

- OEMs Service Contractor Material Suppliers Material & Manpower Supplier

You are associated with us for

- Less than 1 year More than 1 year but less than 3 years More than 3 years

Your office is located at

- Bhubaneswar Within 200 kms from Bhubaneswar More than 200 kms from Bhubaneswar

Your nearly turnover with TPCODL

- Less than 25 Lacs 25 Lacs to 1 Crore More than 1 Cr.

Additional Information

Your Name	
Your Designation	
Your Organization	
Contact Nos.	
Email	

We once again thank you for your participation in this survey. Please spare 10 minutes to give your feedback on following pages (Section A to E)

SECTION – A

(Please ✓ mark in the relevant box and give your remarks / suggestions / information for our improvement).

S. No.	Parameters	1	2	3	4	5	Remarks/ Suggestion
		Do Not Agree	Slightly in Agreement	In Fair Agreement	Mostly in Agreement	Fully Agree	
1	You receive all relevant queries / tenders from us in timely manner.						
2	We provide you enough lead time to respond to our queries / tenders.						
3	We provide you adequate support (drawings, documents, clarifications, briefing etc.) to enable you meet our requirements.						
4	All following elements of our contract / purchase order are rational :						
4.1	Scope of Work						
4.2	Delivery / Execution Schedule						
4.3	Payment Terms						
4.4	Liquidated Damages						
4.5	Performance Guarantee						
5	Our purchase orders / contracts are simple, specific & easy to understand						
6	TPCODL demonstrate willingness to be flexible in administration of Contract / Purchase Order						
7	We provide timely responses / clarifications to your queries						
8	TPCODL representative you interact / coordinate with is adequately empowered to support you in meeting contractual obligations						
9	TPCODL provide you all necessary infrastructure support for timely and quality completion of work (including AMC)						
10	TPCODL Engineer-in-Charge timely certifies the jobs executed/ material supplied						
11	TPCODL Engineer-in-Charge efficiently supervises the job execution for timely completion of job						
12	BIRD (Bill Inward Receipt Desk) initiative has improved payment disbursement process						

Doc. Title	GENERAL CONDITIONS OF CONTRACT FOR SUPPLY ORDERS	
Rev. No	0	Page 33 of 43

S. No.	Parameters	1	2	3	4	5	Remarks/ Suggestion
		Do Not Agree	Slightly in Agreement	In Fair Agreement	Mostly in Agreement	Fully Agree	
13	Our approach for Inspection and Quality Assurance effective to expedite project completion?						
14	TPCODL never defaults on contractual terms						
15	In TPCODL Contracts closure is done within set time limit						
16	Our material receiving procedures are well defined and efficiently deployed to reduce mutual inconvenience						
17	Bank Guarantees are released in time bound manner						
18	Our processes related to payment / account settlement are effective.						
19	You get payments on time						
20	TPCODL Employees follow Ethical behaviour						

Doc. Title	GENERAL CONDITIONS OF CONTRACT FOR SUPPLY ORDERS	
Rev. No	0	Page 34 of 43

SECTION – B

SECTION – B (Please rate the following parameters on a scale of 1 to 5, where 1 - Minimum; 5 - Maximum)

S. No.	Parameters	1	2	3	4	5	Remarks/ Suggestion
1	How do you rate courtesy/ empathy/ attitude level and warmth of TPCODL employees you interact with from following team?						
1.1	Project Engineering						
1.2	District / Zones						
1.3	Projects/HOG (TS &P)						
1.4	Inspection & Quality Assurance						
1.5	Stores						
1.6	Metering & Billing						
1.7	Accounts / Finance						
1.8	Administration						
1.9	IT & Automation						
2	How would you rate TPCODL in comparison to your other clients in terms of fairness of treatment and transparency with its Business Associates?						
3	How would you rate TPCODL in comparison to your other clients in terms of processes and systems to manage partnership with its Business Associates						
4	How would you rate TPCODL in comparison to your other clients in terms of building long term & mutually relationship with its Business Associates						

SECTION – C

Please √ mark in the relevant box and give your remarks / suggestions / information for our improvement.

S. No.	Parameters	Certainly No	Probably No	Certainly Yes	Probably Yes	Remarks/ Suggestion
1	Based on your experience with TPCODL, would you like to continue your relationship with TPCODL?					
2	If someone asks you about TPCODL, would you talk "positively" about					

	TPCODL?					
3	Would you refer TPCODL name to others in your community, fraternity and society as a professional & dynamic organization?					

SECTION - D

If we ask you to rate us on a scale of 1 to 10, how will you rate TPCODL, that truly represents your overall satisfaction with us (please tick appropriate box) -

1	2	3	4	5	6	7	8	9	10
---	---	---	---	---	---	---	---	---	----

SECTION - E

Please ✓ mark in the relevant box and give your remarks / suggestions / information for our improvement.

Please spare your thoughts for TPCODL's improvement in particular areas of weaknesses, particularly relating to some great practices, attitudes that you have seen elsewhere in Indian and International Organizations, which you recommend TPCODL to adopt. Please give your valuable salient recommendations.

Please spare your thoughts for TPCODL's improvement in particular areas of major concerns for you. We also welcome your suggestions to adopt any best practices, altitudes that you

Recommendation	<i>Please tick (✓) your top 5 expectations out of the following 10 points listed below -</i>	
(Please list down improvement you expect from TPCODL)	<i>Timely payment</i>	
1	<i>Flexibility in Contracts/PO</i>	
	<i>Clarity in PO,s & Contracts</i>	
2	<i>Timely response to quarries</i>	
	<i>Timely certification of works executed</i>	
3	<i>Clarity in Specs, drawings, other docs etc.</i>	
	<i>Adequate information provided on website for tender notification, parties qualified etc.</i>	
4	<i>Timely receipt of material at site for execution</i>	
	<i>Performance Guarantee/EMD released in time</i>	

Doc. Title	GENERAL CONDITIONS OF CONTRACT FOR SUPPLY ORDERS	
Rev. No	0	Page 36 of 43

5	<i>Inspection & quality assurance support for timely job completion</i>
---	---

We thank you for your time and courtesy!!

ANNEXURE-F

ACCEPTANCE FORM FOR PARTICIPATION IN REVERSE AUCTION EVENT

(To be signed and stamped by the bidder prior to participation in the auction event)

In a bid to make our entire procurement process more fair and transparent, TPCODL intends to use the reverse auctions through SAP-SRM tool as an integral part of the entire tendering process. All the bidders who are found as technically qualified based on the tender requirements shall be eligible to participate in the reverse auction event.

The following terms and conditions are deemed as accepted by the bidder on participation in the bid event:

1. TPCODL shall provide the user id and password to the authorized representative of the bidder. (Authorization Letter in lieu of the same shall be submitted along with the signed and stamped Acceptance Form).
2. TPCODL will make every effort to make the bid process transparent. However, the award decision by TPCODL would be final and binding on the supplier.
3. The bidder agrees to non-disclosure of trade information regarding the purchase, identity of TPCODL, bid process, bid technology, bid documentation and bid details.
4. The bidder is advised to understand the auto bid process to safeguard themselves against any possibility of non-participation in the auction event.
5. In case of bidding through Internet medium, bidders are further advised to ensure availability of the entire infrastructure as required at their end to participate in the auction event. Inability to bid due to telephone line glitch, internet response issues, software or hardware hangs, power failure or any other reason shall not be the responsibility of TPCODL.
6. In case of intranet medium, TPCODL shall provide the infrastructure to bidders. Further, TPCODL has sole discretion to extend or restart the auction event in case of any glitches in infrastructure observed which has restricted the bidders to submit the bids to ensure fair & transparent competitive bidding. In case an auction event is restarted, the best bid as already available in the system shall become the start price for the new auction.
7. In case the bidder fails to participate in the auction event due any reason whatsoever, it shall be presumed that the bidder has no further discounts to offer and the initial bid as submitted by the bidder as a part of the tender shall be considered as the bidder's final no regret offer. Any offline price bids received from a bidder in lieu of non-participation in the auction event shall be out rightly rejected by TPCODL.
8. The bidder shall be prepared with competitive price quotes on the day of the bidding event.
9. The prices as quoted by the bidder during the auction event shall be inclusive of all the applicable taxes, duties and levies and shall be FOR at TPCODL site.
10. The prices submitted by a bidder during the auction event shall be binding on the bidder.
11. No requests for time extension of the auction event shall be considered by TPCODL.
12. The original price bids of the bidders shall be reduced on pro-rata basis against each line item based on the final all inclusive prices offered during conclusion of the auction event for arriving at Contract amount.

Signature & Seal of the Bidder

Doc. Title	GENERAL CONDITIONS OF CONTRACT FOR SUPPLY ORDERS	
Rev. No	16	Page 38 of 43

Name of the Authorized Signatory: _____ :

Contact Person's Name:

Official Correspondence Address:

We confirm that we will bear the charges, if any, levied by our bank for the credit of NEFT/RTGS amounts in our account. Any change in above furnished information shall be informed to TPCODL well in time at our own. Further, we kept TPCODL indemnified for any loss incurred due to wrong furnishing of above information.

Thanking you,

For _____

(Authorised Signatory)

(Signature with Rubber Stamp)

Certification from Bank:

We confirm that we are enabled for receiving NEFT/RTGS credits and we further confirm that the account number (specify Bank a/c no.) of (Please mention here name of the account holder), the signature of the authorised signatory and the MICR and IFSC Code of our branch mentioned above are correct.

This also is certified that the above information is correct as per Bank record

(Manager's/ Officers Signature under Bank Stamp)

ANNEXURE-H
VENDOR APPRAISAL FORM

TO BE SUBMITTED BY VENDOR (To be filled as applicable)			
VENDOR:			
1.0	DETAILS OF THE FIRM		
	1.1	NAME (IN CAPITAL LETTERS)	:
	1.2	TYPE OF CONCERN (PROPRIETARY) Partnership, Pvt. Ltd., Public Ltd. etc.	:
	1.3	YEAR OF ESTABLISHMENT	:
	1.4	LOCATION OF OFFICE POSTAL ADDRESS TELEGRAPHIC ADDRESSES, TELEX NO. FAX NO.	:
	1.5	LOCATION OF MANUFACTURING UNITS	:
		i) UNITS 1	:
		ii) OTHER UNITS	:
2.0	PRODUCTS MANUFACTURED		
3.0	TURNOVER DURING THE LAST 3 YEARS (TO BE VERIFIED WITH THE LATEST PROFIT & LOSS STATEMENT).		
4.0	VALUE OF FIXED ASSETS		
5.0	NAME & ADDRESS OF THE BANKERS		
6.0	BANK GUARANTEE LIMIT		
7.0	CREDIT LIMIT		
8.0	TECHNICAL		
	8.1	NO. OF DESIGN ENGINEERS (INDICATE NO. OF YEARS EXPERIENCE IN RELATED FIELDS)	:
	8.2	NO. OF DRAUGHTS MEN	:
	8.3	COLLABORATION DETAILS (IF ANY)	:
		8.3.1 DATE OF COLLABORATION	:
		8.3.2 NAME OF COLLABORATOR	:
		8.3.3 RBI APPROVAL DETAILS	:
		8.3.4 EXPERIENCE LIST OF COLLABORATOR	:
		8.3.5 DURATION OF AGREEMENT	:
	8.4	AVAILABILITY OF STANDARDS / DESIGN PROCEDURES / COLLABORATOR'S /	:

Doc. Title	GENERAL CONDITIONS OF CONTRACT FOR SUPPLY ORDERS	
Rev. No	16	Page 40 of 43

		DOCUMENTS (CHECK WHETHER THESE ARE LATEST/CURRENT)	
	8.5	TECHNICAL SUPPORT, BACK-UP GUARANTEE, SUPERVISION, QUALITY CONTROL BY COLLABORATOR (WHEREVER ESSENTIAL). (THIS CLAUSE IS RELEVANT WHEN VENDOR'S EXPERIENCE IS INADEQUATE)	:
	8.6	QUALITY OF DRAWINGS	:
9.0	MANUFACTURE		
	9.1	SHOP SPACE, LAYOUT LIGHTING, VENTILATION, ETC.	:
	9.2	POWER (KVA)	:
		MAINS INSTALLED	:
		UTILIZED	:
		STANDBY POWER SOURCE	:
	9.3	MANUFACTURING FACILITIES (ATTACH LIST OF EQUIPMENT AS APPLICABLE)	:
		9.3.1 MATERIAL HANDLING	:
		9.3.2 MACHINING	:
		9.3.3 FABRICATION	:
		9.3.4 HEAT TREATMENT	:
		9.3.5 BALANCING FACILITY	:
		9.3.6 SURFACE TREATMENT PRIOR TO PAINTING/ COATING, POLISHING, PICKLING, PASSIVATION, PAINTING, ETC.	:
	9.4	SUPERVISORY STAFF	:
	9.5	ADEQUACY OF SKILLED LABOURS (MACHINISTS, WELDERS, ETC.)	:
	9.6	NO. OF SHIFTS	:
	9.7	TYPE OF MATERIAL HANDLED (SUCH AS CS, SS, ETC.)	:
	9.8	WORKMANSHIP	:
	9.9	MATERIAL IN STOCK AND VALUE	:
	9.10	TRANSPORT FACILITIES	:
	9.11	CARE IN HANDLING	:
10.0	INSPECTION / QC / QA / TESTING		
	10.1	NUMBER OF PERSONNEL (INDICATE NO. OF YEARS OF EXPERIENCE)	:
	10.2	INDEPENDENCE FROM PRODUCTION	:

Doc. Title	GENERAL CONDITIONS OF CONTRACT FOR SUPPLY ORDERS	
Rev. No	16	Page 41 of 43

	10.3	AVAILABILITY OF PROCEDURAL WRITE UP/QUALITY PLAN	:
	10.4	INCOMING MATERIAL CONTROL AND DOCUMENTATION	:
	10.5	RELIABILITY/REPUTATION OF SUPPLY SOURCES	:
	10.6	STAGE INSPECTION AND DOCUMENTATION	:
	10.7	SUB-ASSEMBLY & DOCUMENTATION	:
	10.8	FINAL INSPECTION AND DOCUMENTATION	:
	10.9	PREPARATION OF FINAL DOCUMENTATION PACKAGE	:
	10.10	TYPE TEST FACILITIES	:
	10.11	ACCEPTANCE TEST FACILITIES	:
	10.12	CALIBRATION OF INSTRUMENTS AND GAUGES (WITH TRACEABILITY TO NATIONAL STANDARDS) (ATTACH LIST)	:
	10.13	STATUTORY APPROVALS LIKE BIS, IBR, ETC.(AS APPLICABLE)	:
	10.14	SUB-VENDOR APPROVAL SYSTEM AND QUALITY CONTROL	:
	10.15	DETAILS OF TESTS CARRIED OUT AT INDEPENDENT RECOGNIZED LABORATORIES	:
		i) FURNISH LIST OF TESTS CARRIED OUT AND THE NAME OF THE LABORATORY WHERE THE TESTS WERE CONDUCTED	:
		ii) CHECK AVAILABILITY OF CERTIFICATES AND REVIEW THESE WHEREVER POSSIBLE	:
	11.0	EXPERIENCE (INCLUDING CONSTRUCTION / ERECTION / COMMISSIONING) TO BE FURNISHED IN THE FORMAT INDICATED IN APPENDIX)	:
	12.0	SALES, SERVICE AND SITE ORGANIZATIONAL DETAILS	:
	13.0	CERTIFICATE FROM CUSTOMERS (ATTACH COPIES OF DOCUMENTS)	:
	14.0	POWER SITUATION	:
	15.0	LABOUR SITUATION	:
	16.0 *	APPLICABILITY OF SC/ST RELAXATION (Y/N) IF YES, SUPPORTING DOCUMENTS TO BE ATTACHED	
	17.0	ORGANIZATIONAL DETAILS 1. PF NO 2. ESI NO 3. INSURANCE FOR WORK MAN COMPENSATION ACT NO 4. ELECTRICAL CONTRACT LIC NO 5. ITCC / PAN NO 6. SALES TAX NO 7. WC TAX REG. NO	:
	18.0	DOCUMENTS TO BE ENCLOSED:	

Doc. Title	GENERAL CONDITIONS OF CONTRACT FOR SUPPLY ORDERS	
Rev. No	16	Page 42 of 43

	<ol style="list-style-type: none"> 1. FACTORY LICENSE 2. ANNUAL REPORT FOR LAST THREE YEARS 3. TYPE TEST REPORT FOR THE ITEM 4. PAST EXPERIENCE REPORTS 5. ISO CERTIFICATE –QMS, EMS, OHAS, SA 6. REGISTRATION OF SALES TAX 7. COPY OF TIN NO. 8. COPY OF SERVICE TAX NO. 9. REGISTRATION OF CENTRAL EXCISE 10. COPY OF INCOME TAX CLEARANCE. 11. COPY OF PF REGISTRATION 12. COPY OF ESI REGISTRATION 13. COPY OF INSURANCE FOR WORK MAN COMPENSATION ACT NO 14. COPY OF ELECTRICAL CONTRACT LIC NO 15. COPY OF PAN NO 16. COPY OF WC TAX REGISTRATION 17. DOCUMENTS IN SUPPORT OF SC/ST RELAXATION AT S.NO.16.0 18. GSTN CERTIFICATE 	
--	--	--

*** Classification of BA s under SC/ST shall be governed under following guidelines:**

- **Proprietorship/ Single Ownership Firm:** Proprietor of the firm should be from SC/ST community. Governing document shall be Proprietorship Deed.
- **Partnership Firm:** Only such firms shall qualify which have SC/ST partners holding equal to or more than 50% of the total ownership pattern of the firm. Governing document shall be Partnership Deed.
- **Private Limited Company:** Only such firms shall qualify which have SC/ST directors holding equal to or more than 50% of the total ownership pattern of the firm. Governing document shall be Memorandum of Understanding (MoU) and/or Article of Association (AoA).

NOTE: Certification from SC/ST Commission shall be required for deciding upon SC/ST status of a person.

Doc. Title	GENERAL CONDITIONS OF CONTRACT FOR SUPPLY ORDERS	
Rev. No	16	Page 43 of 43

ANNEXURE-I
MANUFACTURER AUTHORIZATION FORM

(To be submitted on OEM's Letter Head)

Date:

Tender Enquiry No.:

To,
Chief (Procurement & Stores)
The TP Central Odisha Distribution Limited,
Bhubaneswar

Sir,

WHEREAS M/s. *[name of OEM]*, who are official manufacturers of having factories at *[address of OEM]* do hereby authorize M/s *[name of bidder]* to submit a Bid in relation to the Invitation for Bids indicated above, the purpose of which is to provide the following Goods, manufactured by us

.....and to subsequently negotiate and sign the Contract.

We hereby extend our full guarantee and warranty in accordance with the Special Conditions of Contract or as mentioned elsewhere in the Tender Document, with respect to the Goods offered by the above firm in reply to this Invitation for Bids.

We hereby confirm that in case, the channel partner fails to provide the necessary services as per the Tender Document referred above, M/s *[name of OEM]* shall provide standard warranty on the materials supplied against the contract. The warranty period and inclusion / exclusion of parts in the warranty shall remain same as defined in the contract issued to their channel partner against this tender enquiry.

Yours Sincerely,

For

Authorized Signatory

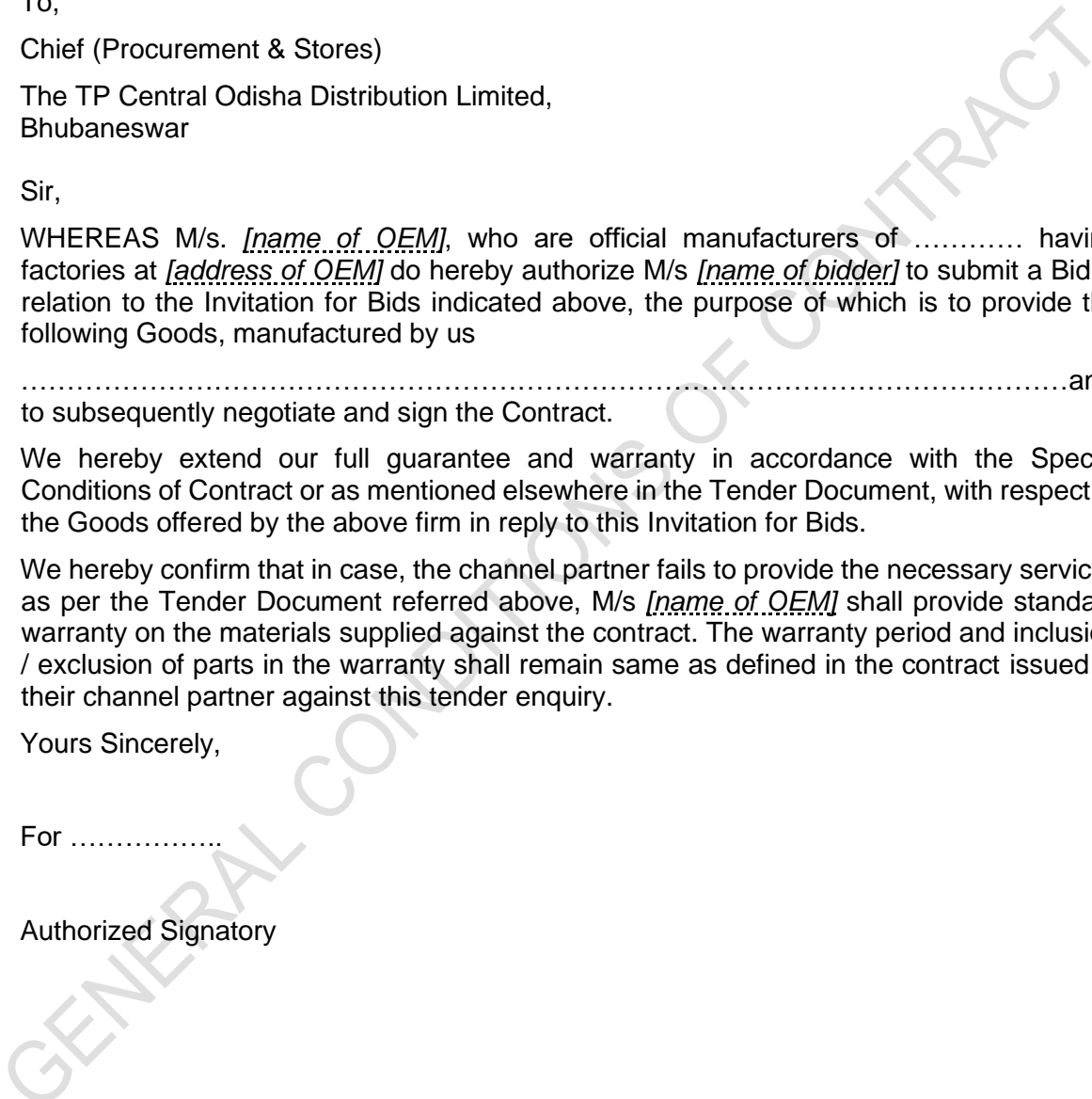

Doc. Title GENERAL CONDITIONS OF CONTRACT –SUPPLY ORDERS

Rev. No 01 (01.12.2021) Page 1 of 47

Prepared By
Imran Ahmad/ Swetaraj Parida

Reviewed By VIPIN CHAUHAN
Vipin Chauhan

Digitally signed by VIPIN CHAUHAN
Date: 2021.12.04 15:13:25 +05'30'

Approved By SUNIL BHATTAR
Sunil Bhattar

Digitally signed by SUNIL BHATTAR
DN: cn=, o=Personal, postalCode=122018,
st=Haryana,
serialNumber=F53CC668A7C5989A74C119
99ACB3A85E57C01F8A37FE5E1358B38
297F0F38, cn=SUNIL BHATTAR
Date: 2021.12.04 15:23:36 +05'30'

CONTENTS

CLAUSE NO.	DESCRIPTION
1.0	ORGANIZATIONAL VALUES
2.0	ETHICS
2.1	Tata Code of Conduct
3.0	CONTRACT PARAMETERS
3.1	Issue/Award of Contract
3.2	Contract Commencement Date
3.3	Contract Completion Date
3.4	Contract Period/ Time
3.5	Contract Execution Completion Date
3.6	Contract Price /Value
3.7	Contract Document
3.8	Contract Language
3.9	Reverse Auction
4.0	SCOPE OF WORK
4.1	Bid Evaluation- Commercial & Technical
5.0	PRICES/RATES/TAXES
5.1	Changes in statutory Tax Structure
6.0	TERMS OF PAYMENT
6.1	Quantity Variation
6.2	Full and Final Payment
7.0	MODE OF PAYMENT
8.0	SECURITY CUM PERFORMANCE DEPOSIT
9.0	STATUTORY COMPLIANCE
9.1	Compliance to Various Acts
9.2	SA 8000
9.3	Affirmative Action
9.4	MSME Development Act 2006
9.5	ISO 14001
10.0	QUALITY
10.1	Knowledge of Requirements
10.2	Material/Equipment/Works Quality
10.3	Adherence to Rules & Regulations
10.4	Specifications and Standards
11.0	INSPECTION/PARTICIPATION

Doc. Title	GENERAL CONDITIONS OF CONTRACT FOR SUPPLY ORDERS	
Rev. No	01 dtd 01.12.2021	Page 2 of 47

CONTENTS	
CLAUSE NO.	DESCRIPTION
11.1	Right to Carry Out Inspection
11.2	Facilitating Inspection
11.3	Third Party Nomination
11.4	Waiver of Inspections
11.5	Incorrect Inspection Call
12.0	MDCC & DELIVERY OF MATERIALS
12.1	Material Dispatch Clearance Certificate
12.2	Right to Rejection on Receipt
12.3	Consignee
12.4	Submission of Mandatory Documents on Delivery
12.5	Dispatch and Delivery Instructions
13.0	GUARANTEE
13.1	Guarantee of Performance
13.2	Guarantee period
13.3	Failure in Guarantee period (GP)
13.4	Cost of repairs on failure in GP
13.5	Guarantee Period for Goods Outsourced
13.6	Latent Defect
13.7	Support beyond the Guarantee Period
14.0	LIQUIDATED DAMAGES
14.1	LD Waiver Request
15.0	UNLAWFUL ACTIVITIES
16.0	CONFIDENTIALITY
16.1	Documents
16.2	Geographical Data
16.3	Associate's Processes
16.4	Exclusions
16.5	Violation
17.0	INTELLECTUAL PROPERTY RIGHTS
18.0	INDEMNITY
19.0	LIABILITY & LIMITATIONS
19.1	Liability
19.2	Limitation of Liability
20.0	FORCE MAJEURE
21.0	SUSPENSION OF CONTRACT
21.1	Suspension for Convenience

Doc. Title	GENERAL CONDITIONS OF CONTRACT FOR SUPPLY ORDERS	
Rev. No	01 dtd 01.12.2021	Page 3 of 47

CONTENTS	
CLAUSE NO.	DESCRIPTION
21.2	Suspension for Breach of Contract Conditions
21.3	Compensation in lieu of Suspension
22.0	TERMINATION OF CONTRACT
22.1	Termination for Default/Breach of Contract
22.2	Termination for Convenience of Associate
22.3	Termination for Convenience of TPNODL
23.0	DISPUTE RESOLUTION AND ARBITRATION
23.1	Governing Laws and jurisdiction
24.0	ATTRIBUTES OF GCC
24.1	Cancellation
24.2	Severability
24.3	Order of Priority
25.0	ERRORS AND OMISSIONS
26.0	TRANSFER OF TITLES
27.0	INSURANCE
28.0	SUGGESTIONS & FEEDBACK
29.0	CONTACT POINTS
30.0	LIST OF ANNEXURES

Doc. Title	GENERAL CONDITIONS OF CONTRACT FOR SUPPLY ORDERS	
Rev. No	01 dtd 01.12.2021	Page 4 of 47

1.0 ORGANIZATIONAL VALUES

The Tata Group has always been a value driven organization. These values continue to direct the Group's growth and businesses. The six core Tata Values underpinning the way we do business are:

Integrity - We must conduct our business fairly, with honesty and transparency. Everything we do must stand the test of public scrutiny.

Understanding - We must be caring, respectful, compassionate and humanitarian towards our colleagues and customers around the world and always work for the benefit of India.

Excellence - We must constantly strive to achieve the highest possible standards in our day to day work and in the quality of goods and services we provide.

Unity - We must work cohesively with our colleagues across the group and with our customers and partners around the world to build strong relationships based on tolerance, understanding and mutual co-operation.

Responsibility - We must continue to be responsible and sensitive to the countries, communities and environments in which we work, always ensuring that what comes from the people goes back to the people many times over.

Agility - We must work in a speedy and responsive manner and be proactive and innovative in our approach.

2.0 Tata Code of Conduct

The Business Associate and TPNODL shall be bound by the provisions/ clauses mentioned in Tata Code of Conduct (TCoC) in all their dealings with stakeholders. The Associate is advised to go through the TCoC document available as Annexure-J.

3.0 CONTRACT PARAMETERS

3.1 Issue/Award of Contract

TPNODL awards the contract to the Associate in writing in the form of Purchase Order (PO) or Rate Contract (RC), hereafter referred as Contract, through in any or all of following modes physical handover / post / e-mail / web document / fax with all the attachments/enclosures which shall be part of the contract document.

On receipt of the contract, the associate shall return to TPNODL copy of the contract document duly signed by legally authorized representative of associate, within two days of Effective Date of Contract for contracts having contract execution time less than 30 days and within five days for all other contracts.

Note- In case of RC though, further Release Orders (RO) shall be issued by TPNODL on RC rates and terms & Conditions as per the requirement of TPNODL.

Doc. Title	GENERAL CONDITIONS OF CONTRACT FOR SUPPLY ORDERS	
Rev. No	01 dtd 01.12.2021	Page 5 of 47

3.2 Contract Commencement Date

The date of issue/award of contract shall be the Effective Date of Contract or Contract Commencement date.

3.3 Contract Completion Date

The date of expiry of Guarantee Period shall be deemed as the Contract Completion Date.

3.4 Contract Period/Time

The period from Contract Commencement Date to Contract Completion Date shall be deemed as the Contract Period/Time.

3.5 Contract Execution Completion Date

The stipulated date for completing the supply as per schedule of quantities shall be deemed as the Contract Execution Completion Date.

3.6 Contract Price /Value

The total all-inclusive price/value mentioned in the PO/RC is the Contract Price/Value and is based on the quantity, unit rates and prices quoted and awarded and shall be subject to adjustment based on actual quantities supplied and accepted and certified by the authorized representative of the company unless otherwise specified in schedule of quantities or in contract documents.

3.7 Contract Document

The Contract Document shall mean and include but not limited to the following:

- NIT/Tender Enquiry, QR, Instruction to Bidders, Special Condition of Contract (SCC) of tender, GCC, Technical & Commercial Specifications including relevant annexure and attachments).
- Bids & Proposals Received from Associate including relevant annexure/attachments.
- RC/PO with agreed deviations from the tender/bid documents.
- All the Inspection and Test reports, Detailed Engineering Drawings.
- Material Dispatch Clearance Certificate (MDCC).
- Minutes of Meeting (MoM)

3.8 Contract Language

All documents, instructions, catalogues, brochures, pamphlets, design data, norms and calculations, drawings, operation, maintenance and safety manuals, reports, labels, on deliveries and any other data shall be in English Language.

The Contract documents and all correspondence between the TPNODL, Third Parties associated with the contract, and the Associate shall be in English language.

However, all signboards required indicating "Danger" and/or security at site and otherwise statutory required shall be in English, Hindi, and local languages.

3.9 Reverse Auction

TPNODL reserves the right to conduct the reverse auction (instead of public opening of price bids) for the products / services being asked for in the tender. The terms and conditions for such reverse auction events shall be as per the Acceptance Form attached in Annexure F. The

Doc. Title	GENERAL CONDITIONS OF CONTRACT FOR SUPPLY ORDERS	
Rev. No	01 dtd 01.12.2021	Page 6 of 47

bidders along with the tender document shall mandatorily submit a duly signed copy of the Acceptance Form as mentioned in the Annexure J as a token of acceptance for the same.

4.0 SCOPE OF WORK

All the activities that are to be undertaken by the Associate to realize the contractual deliverables in completeness form Scope of Work. Following clauses list, but not limited to, major requirements of the scope of work.

The associate shall satisfy himself and undertake fully the technical/commercial requirements of items to be supplied as listed in the Schedule of Quantities together with the tests to be performed /test reports to be furnished before dispatch, arrangement of stage and final inspections during manufacturing as per terms and conditions of contract, technical parameters & delivery terms and conditions including transit insurance to be met in order to fully meet TPNODL's requirements.

Completeness: Any supplies and services which might have not been specifically mentioned in the Contract but are necessary for the scope mentioned in Special Terms & Conditions and/or completeness of the works at the highest possible level, including any royalties, license fees & compensation to be paid, whether incurred by the associates or by a third party for the work covered in the scope, regardless of when incurred, shall be supplied/provided by the associate without any extra cost and within the time schedule for efficient, smooth and satisfactory operation and maintenance of the works at the highest possible level under Indian conditions (but according to international standards for facility of this type), unless expressly excluded from the scope of supplies and services in this Contract.

TPNODL have the right, during the performance of the Contract, to change the scope and/or technical character of the Project and/or of the supplies and services stipulated in the Contract by submitting a request in writing to the Associate. The Associate shall, within fifteen days of receipt of such request from the TPNODL, provide Purchaser with a reasonably detailed estimate of the cost of the change outlined in the request.

In the event, TPNODL requests a change, the Contract price and time shall be adjusted upwards or downwards, as the case may be and shall be mutually agreed to. The associate shall not be entitled to any extension of time unless such changes adversely affect the time schedule.

The Associate shall not proceed with the changes as requested till adjustment of contract price and time schedule where so applicable in terms of or otherwise directed by the TPNODL.

4.1 Bid Evaluation- Commercial & Technical

TPNODL reserves the right to evaluate the bid on below parameters as per the requirement:

Commercial Evaluation: The bid shall be evaluated on the basis of Qualifying Requirement parameters and other commercial parameters as mentioned in tender.

Technical Evaluation: The bid shall be evaluated on the parameters and not limited to Bidder Experience, Bidder Performance with other utility/company, internal performance feedback, Technical Specification, General Technical Parameters (GTP), Layout, Drawings etc.

TPNODL reserves the right to carry out Factory Evaluation of Manufacturer along with the Visit to executed Sites for further evaluation to ascertain bidder's manufacturing capability, quality procedures & Performance of executed works.

Doc. Title	GENERAL CONDITIONS OF CONTRACT FOR SUPPLY ORDERS	
Rev. No	01 dtd 01.12.2021	Page 7 of 47

5.0 PRICES/RATES/TAXES

Unless specified elsewhere in the contract document, the prices/rates are inclusive of cost of finished product for which MDCC will be issued by TPNODL, packaging and forwarding charges, freight and transit insurance charges covering loading at Associate's works, transportation to TPNODL store/site & unloading & delivery at TPNODL stores/TPNODL site, cost of documentation including all the relevant test certificates and other supportive documents to be furnished.

The Prices/Rates are inclusive of all taxes, levies, cess and duties, particularly Goods and Services Tax as applicable. All government levy / taxes shall be paid only when the invoice is submitted according to the relevant act.

The prices/rates shall remain firm till actual completion of entire supply of goods/material/equipment as per contract is achieved and shall remain valid till the completion of the contract.

The prices shall remain unchanged irrespective of TPNODL making changes in quantum in all or any of the schedules of items of contract.

5.1 Changes in Statutory Tax Structure

If rate of any or all of the statutory taxes and duties applicable to the contract changes, such changes shall be incorporated by default if the changes occur within the contract execution time and shall be applicable if the contract is executed by the Associate within the Contract Execution Time.

For execution of contracts beyond contract execution time, where the delay is not attributable to TPNODL no upward revision in tax /duties shall be considered irrespective of changes in the statutory tax structure either within the contract execution time or beyond. However, in such cases, benefits due to any downward revisions in statutory tax rates shall be passed on to TPNODL.

6.0 TERMS OF PAYMENT

On delivery of the materials in good condition and certification of acceptance by TPNODL official, Associate shall submit the Bills/Invoices in original in the name of "TPNODL" to invoice desk, complete with all required documents as under:

- Test Reports (4 sets).
- MDCC issued by TPNODL.
- Packing List.
- Drawing and Catalogue.
- Guarantee/Warranty Card.
- Delivery Challan.
- O&M Manual.
- Copy of Order.
- Minutes of Meeting.

Doc. Title	GENERAL CONDITIONS OF CONTRACT FOR SUPPLY ORDERS	
Rev. No	01 dtd 01.12.2021	Page 8 of 47

- E-Way challan (if applicable)

Bills/ invoices shall mention Supplier's GST Number. TPNODL will make 100% payment within 45 days of submission of the Bill/Invoice complete in all respects and along with all the requisite documents mentioned above, subject to condition that Associate has furnished the requisite Security-cum-Performance Guarantee as stipulated in the contract.

6.1 Quantity Variation

Payment will be made on the basis of actual quantity of supplies/actual measurement of works accepted by TPNODL and not on the basis of contract quantity.

6.2 Full and Final Payment

Full & Final Payment in all contracts shall be made subject to the associate submitting "No Demand Certificate" in the format as per Annexure-C.

7.0 MODE OF PAYMENT

Payment shall be made through crossed RTGS/ NEFT/ Online Net banking mode whichever of the two modes chosen by the Associate, in favour of Associate's Bank Account on TPNODL records, on whose name Contract has been issued. Those Associates opting for the RTGS mode shall submit the details of Bank Account and other details as per annexure G. Further, for any payments made, TPNODL is not responsible for any consequences/disputes Associate have among the owners channel partners, sub-Associates and all such dispute/concerns shall be settled solely by the Associate.

8.0 SECURITY CUM PERFORMANCE DEPOSIT

Associates shall submit within 21 days from the effective date of issue of PO/RC, Security Performance Bank Guarantee (SPBG) in the format as per Annexure B of this document from banks acceptable to TPNODL for:

- (a) 5% of the PO value if purchase order value is more than Rs 5 Crores.
- (b) 10% of the PO value if purchase order value is less than Rs 5 Crores.
- (c) 5% of the RC value in case of Rate Contract. This shall remain valid till the Guarantee period plus one month.

In case, PBG will not submitted by BA within 21 days post awarding the contract, TPNODL will reserve the right to take any appropriate action. However, in case of non-submission of PBG till the date of first bill submission, the amounts towards PBG shall be retained by TPNODL from Bills.

The validity of PBG shall be Guarantee Period of contract, plus one month.

- For PO/RC values less than Rs. 5 lacs, Associate may request for deduction of amount equivalent to SPBG value from their first invoice. Such amount shall be withheld by TPNODL while processing the invoice and shall be released after completion of Guarantee Period plus one month.
- For PO/RC values less than Rs. 3 lacs, the clause (8.0) for Security cum Performance Bank Guarantee (SPBG) shall not be applicable.

Doc. Title	GENERAL CONDITIONS OF CONTRACT FOR SUPPLY ORDERS	
Rev. No	01 dtd 01.12.2021	Page 9 of 47

- In case of RC (Rate Contract) after the expiry of RC validity, Associate shall have to submit SPBG. However, the Associate has the option to re-submit the SPBG as per actual RO (Release Order) value issued against the RC, valid for Guarantee Period plus one month. The Guarantee Period shall be considered as per the last RO issued against the said RC. The original SPBG as submitted against the RC shall be released on submission of the new SPBG to TPNODL. Alternatively, Associate may extend the validity of original SPBG only till the requisite period, i.e. Guarantee Period plus one month.

9.0 STATUTORY COMPLIANCE

9.1 Compliance to Various Acts

Associate should ensure adherence to all applicable laws, rules and regulation applicable under this contract from time to time. In case of violation any risk, costs etc shall be in associates account and keep TDPPL indemnified always till completion of contracts.

9.2 SA 8000

As TPNODL/ Tata Power is SA 8000 compliant, it expects its Associates to follow guidelines of SA 8000:2014 on the following aspects

1. Child Labour
2. Forced or Compulsory Labour
3. Health & Safety
4. Freedom of Association & Right to Collective Bargaining
5. Discrimination
6. Disciplinary Practices
7. Working Hours
8. Remuneration
9. Management System

9.3 Affirmative Action

TPNODL appreciate and welcome the engagement/employment of persons from SC/ST community or any other deprived section of society by their business associates.

Relaxation in Contract Clauses under Affirmative Action for SC/ ST Business Associates**

TPNODL believes that inclusive growth is the key to sustainable development, and to promote the same Policy on Affirmative Action for Scheduled Caste & Scheduled Tribe Communities has been adopted across the company.

Under the same pre-text, and to promote entrepreneurship among SC/ST community TPNODL has taken initiative by proposing relaxations in contract clauses as per below:

S. No	Initiative	for SC/ ST BA's	Guideline Document
1	Tender Fees	100% waiver for SC/ST community	All Open Tenders

Doc. Title	GENERAL CONDITIONS OF CONTRACT FOR SUPPLY ORDERS	
Rev. No	01 dtd 01.12.2021	Page 10 of 47

2	Earnest Money Deposit	50 % relaxation of estimated EMD value	All limited and Open Tenders
3	Performance Bank Guarantee	50% relaxation in PBG for order value above 50 lacs else 25% relaxation	All limited and Open tenders
4	Turnover	25% relaxation in company turnover under qualifying requirement criteria	All Open Tenders

****Classification of BAs under SC/ST shall be governed under following guidelines:**

- Proprietorship/ Single Ownership Firm: Proprietor of the firm should be from SC/ST community. Governing document shall be duly audited balance Sheet for the last FY bearing the name of proprietor.
- Partnership Firm: Only such firms shall qualify which have SC/ST partners holding equal to or more than 50% of the total ownership pattern of the firm. Governing document shall be Partnership Deed and audited balance sheet/ ITR for last FY.
- Private limited company: Only such firms shall qualify which have SC/ST directors holding equal to or more than 50% of the total ownership pattern of the firm. Governing document shall be Memorandum of Understanding (MoU) and/or Article of Association (AoA).

Governing document shall be Memorandum of Understanding (MoU) and/or Article of Association (AoA).

Note: Certification from SC/ST commission shall be required for deciding upon SC/ST status of a person.

9.4 MSME Development ACT 2006

Provisions for Firms falling in The Micro, Small and Medium Enterprise Development Act 2006:-

- Business Associate is requested to inform the TPNODL if they fall under provisions of The Micro, Small and Medium Enterprises Development Act, 2006 legislation, and provide necessary documents to TPNODL. The Associate also needs to mention the relevant details on their invoice/ bill.
- Business Associate shall submit the self-undertaking of registration in MSME category at the time of bidding as well as on an annual basis to TPNODL, enabling them to avail the consequent benefits, failing which TPNODL may take appropriate action against such defaults.
- Business Associates falling in MSME category can avail the following benefits-
 - a. **Tender Fees:** To participate in the tender, MSMEs registered in the State of Odisha shall pay Rs.1,000/- including GST towards cost of tender paper.
 - b. **Earnest Money Deposit (EMD):** EMD shall be exempted for MSME registered in the State of Odisha. However, Bidder shall be barred to participate in the tendering process for a period of 2 years in case it backs out post award of the contract.
 - c. **Qualification Requirement for Open Tenders:** Qualification Requirement of Financial Turnover for MSME registered in the State of Odisha shall be reduced to 20% of the existing criteria. For past experience, instead of relying on the volumes / value of earlier Supplies / Projects, assessment of the Bidder shall be done on the basis of feedback from Customers. Past performance experience at

Doc. Title	GENERAL CONDITIONS OF CONTRACT FOR SUPPLY ORDERS	
Rev. No	01 dtd 01.12.2021	Page 11 of 47

Tata Power/ TPNODL and its Group Companies shall supersede feedback from other Customers.

- d. **Reservation for MSME:** TPNODL reserve the rights to procure at least 20% of the total volume of the procurement from MSME registered in the State of Odisha (however, it shall not apply where goods/services are not available with the MSME), subject to matching L1 discovered prices and meeting technical specifications including quality requirements.
- e. **Performance Bank Guarantees:** Performance Bank Guarantee for MSME registered in the State of Odisha shall be 25% of the value normally prescribed.

9.5 ISO 14001

The vendor to confirm whether their organization is ISO 14001 certified. If not, the Vendor must certify that the handling, use and disposal of their product/ by-products conform to practices consistent with sound environment management and local statues. The Vendor shall ensure that all the wastes are disposal in environmental friendly way with strict compliance to applicable laws including adherence to MoEF guidelines with respect to the disposal of batteries, lead waste, copper cables, ash, waste oil, e-waste etc. which shall be disposed through MoEF approved parties only. The vendor shall also dispose off the e-waste generated at the end of the product life cycle at its own costs and risk as per the MoEF guidelines/ Orders

10.0 QUALITY

10.1 Knowledge of Requirements

The Associate shall be deemed to have carefully examined and to have knowledge of the equipment, the general and other conditions, specifications, schedules, drawings, etc. forming part of the Contract and also to have satisfied himself as to the nature and character of the work to be executed and the type of the equipment and duties required including wherever necessary of the site conditions and relevant matters and details. Any information thus procured or otherwise obtained from TPNODL/Consultants shall not in any way relieve the Associate from his responsibility and executing the works in accordance with the terms of contract.

10.2 Material/Equipment/Works Quality

The items / works under the scope of the Associate shall be of the best quality and workmanship according to the latest engineering practice and shall be manufactured from materials of best quality considering strength and durability for their best performance and, in any case, in accordance with the specifications set forth in this Contract. All material shall be new. Substitution of specified material or variation from the process of fabrication/ construction/ manufacture may be permitted but only with the prior written approval of the TPNODL.

10.3 Adherence to Rules & Regulations

The Associate shall procure and/or fabricate/erect all materials and equipment in accordance with all requirements of Central and State enactment, rules and regulations governing such work in India and at site. This shall not be construed as relieving the Associate from complying with any requirement of TPNODL as enumerated in the Contract which may be more rigid than and not contrary to the above mentioned rules, nor providing such construction as may be required by the above mentioned rules and regulations. In case of variance of the Technical

Doc. Title	GENERAL CONDITIONS OF CONTRACT FOR SUPPLY ORDERS	
Rev. No	01 dtd 01.12.2021	Page 12 of 47

Specification from the laws, ordinance, rules and regulations governing the work, the Associate shall immediately notify the same to the TPNODL. It is the sole responsibility of the Associate, however, to determine that such variance exists. Wherever required by rules and regulations, the Associate shall also obtain the statutory authorities' approval for the plant, machinery and equipment to be supplied by the Associate.

10.4 Specifications and Standards

The Associate shall follow all codes and standards referred in the Contract Document. Codes and standards of other may be followed by the Associate with the prior written approval of TPNODL, provided materials, supplies and equipment according to the standard are equal to or better than the corresponding standards specified in the Contract.

Brand names mentioned in the Contract documents are for the purpose of establishing the type and quality of products to be used. The Associate shall not change the brand name and qualities of the bought out items without the prior written approval of the TPNODL. All such products and equipment shall be used or installed in strict accordance with original manufacturer's recommendations, unless otherwise directed by the TPNODL. In any circumstances the codes, specimen and standards prescribed by any government agency should not be violated.

11.0 INSPECTION/PARTICIPATION

11.1 Right to Carry Out Inspection

TPNODL reserves the right to send its representatives for inspection or participation at various stages of contract execution listed below, applicable as per contract construction.

- During basic design and detail engineering of material/ Equipment carried out by Associate /Outsourced Agencies.
- During manufacturing stages of the product at Associate's/Associate's Outsourced Agency's Plant/Facility.
- During Pre-dispatch Inspection and Testing of finished/manufactured product at Associate's/Associate's outsourced Agency's Plant/Facility.
- During Installation & Commissioning Activities/Stages.
- Prior to Clearing of the completed installation for commissioning.
- Any other stage as find appropriate by TPNODL during contract execution time.

All inspections and participations shall be carried out by TPNODL giving written intimation to the Associate or receiving appropriate advance written inspection call from the Associate, unless otherwise specified elsewhere in the contract document.

MDCC request shall be submitted by BA to TPNODL at least 7 days before inspection date.

11.2 Facilitating Inspection

The Associate shall provide all opportunities and information to TPNODL's engineers to get acquainted with the technical know-how and the methods and practices adopted by the Associate in basic and detail engineering. The Associate shall provide documents, drawings, calculations etc. as may be required by TPNODL's Engineers.

The Associate shall provide free of charge office accommodation, office facilities, secretarial services, communication facilities, general and drawing office stationary, etc. as may be

Doc. Title	GENERAL CONDITIONS OF CONTRACT FOR SUPPLY ORDERS	
Rev. No	01 dtd 01.12.2021	Page 13 of 47

reasonably required by the TPNODL's engineers. Similarly, facilities shall also be provided by Associate's outsource agencies/partners/authorized dealers (collectively termed as sub associates) if such basic and detail engineering activities are carried out in the design offices of sub-Associates.

The Associate shall be responsible for the safety of employees of TPNODL/Third Party Agency when they are at the Associate's /Associate's outsource agency's plant or facility for carrying out/witnessing inspection/testing. All statutory safety precautions as applicable shall be followed by the Associate during Inspection Testing. If TPNODL inspectors are not satisfied with the safety arrangements at the plant, TPNODL have the right to call off inspection till such time corrective action is taken by the Associate.

Before raising the call for pre-dispatch final inspection and testing, the Associate shall conduct all the tests—type tests, routine tests etc-as specified in the contract document and submit copies of the test certificates to TPNODL along with the inspection call, for scrutiny of TPNODL.

The Associate and TPNODL shall jointly document all the observations, comments and action points after completion of inspection and it shall be binding on the Associate to provide compliance on all the points requiring compliance and furnish the compliance report to the designated authority of TPNODL for receiving clearance for dispatch of materials

11.3 Third Party Nomination

TPNODL also may nominate a third party for the purpose of carrying out the inspection and such an agency shall be entitled to all the rights and privileges of TPNODL as far as conducting the inspection.

11.4 Waiver of Inspections

TPNODL on its own discretion shall chose to waive off any inspection and ask the Associate to submit all the test reports as applicable as per contract specifications, related to inspection and testing of the goods ordered for scrutiny and clearance for dispatch.

11.5 Incorrect Inspection Call

In case it is observed that the material offered for inspection is not ready at the time of TPNODL inspection visit rendering it as futile, all costs towards such inspection shall be recovered from the BA. Taxes as applicable on such recoveries shall be borne by the BA.

12.0 MDCC & DELIVERY OF MATERIALS

12.1 Material Dispatch Clearance Certificate

Associate shall deliver material/goods/equipment against Supply Contracts or Supply Part of Composite/Service Contracts only after receiving Material Dispatch Clearance Certificate (hereafter termed as MDCC) issued by designated authority of TPNODL. Material delivered at TPNODL stores or at project site without a valid MDCC issued by the designated official of TPNODL shall be rejected. MDCC shall be issued to associate furnishing compliance report on the action points documented during pre-dispatch inspection and testing at Associate's/ Sub Associate's plant/ facility. In case Pre-dispatch inspection is waived at the discretion of TPNODL, then, MDCC shall be issued on receiving all the test reports-routine& type-from the Associate and finding them in order.

The associate shall include and provide for securely protecting and packing the materials so as to avoid loss or damage during handling and transport by air, sea, rail and road or any other means.

Doc. Title	GENERAL CONDITIONS OF CONTRACT FOR SUPPLY ORDERS	
Rev. No	01 dtd 01.12.2021	Page 14 of 47

All such packing shall allow to the extent possible for easy removal and checking at Site. The associate shall take special precautions to prevent rusting of steel and iron parts during transit by sea. Gas seals or other materials shall be utilized by the associate for protection against moisture during transit of all Plant and Equipment.

Each Equipment or parts of Equipment shall be tagged with reference to the assembly drawings and corresponding part numbers. Each bale or package shall contain a packing note quoting specifically the name of the associate, item description, quantity, item / package identification.

All packing cases, containers, packing and other similar materials shall be new and supplied free by the associate and it shall not be required to be returned to the associate.

Notwithstanding anything stated in this clause, the associate shall be entirely responsible for loss, damage or depreciation or deterioration to the materials and supplies due to faulty and/or insecure packing or otherwise during transportation to the Site until otherwise provided herein.

In case of the consignments dispatched by road, the associate shall ensure that it or its subcontractors:

- i) Identify and obtain the correct type of trucks/trailers, keeping in view the nature of consignments to be dispatched.
- ii) Take such actions as may be necessary to avoid all possible chances of damages during transit and to ensure that all packages are firmly secured.

Timelines for inspection and MDCC is as below:

S. No.	Inspection	MDCC issuance time including Inspection time (max.)
1	Outside Odisha	12 days
2	Within Odisha	5 days
3	Waiver*	3 working days

* Associate is expected to raise the inspection call assuming that Inspection shall be carried out by TPNODL. The decision for waiver of inspection shall be on sole discretion of TPNODL.

12.2 Right to Rejection on Receipt

Goods/Material/Equipment delivered in condition physically damaged & incomplete as a product ordered, or not packed and transported as per the terms and conditions of the contract is liable to be rejected. Such item shall be lifted back by Associates within 15 days from receipt of rejection note from TPNODL and have to supply back the material within next 30 days or within the timeframe mutually decided by Associate and TPNODL.

If delivery of the material is beyond the agreed time, Liquidated damage clause, mentioned in this GCC separately shall be applicable; but the period for levy of LD shall be considered as per the original delivery schedule and not from the agreed timelines for material rectification.

12.3 Consignee

Unless otherwise specified in the Contract Document, Materials/Goods/Equipment shall be consigned to "Stores-In-Charge", TPNODL, Balasore/ Jajpur/ others.

Doc. Title	GENERAL CONDITIONS OF CONTRACT FOR SUPPLY ORDERS	
Rev. No	01 dtd 01.12.2021	Page 15 of 47

12.4 Submission of mandatory documents on Delivery

Following documents shall be mandatorily submitted by BA along with supply of material to TPNODL stores/site:

S. No.	Documents	Requisite
1	Invoice copy in original	With all consignments
2	LR copy	Wherever required
3	Packing list	With all consignments
4	MDCC	With all consignments
5	Purchase order / Release order	Signed copy
6	Test certificates	With all consignments
7	Inspection/JVR report	In case pre-dispatch inspection is conducted
8	Device data in CD as per template for metering items	Wherever applicable

12.5 Dispatch and Delivery Instructions

S. No.	Instructions
1	Purchase order/ Release order no. shall be mentioned on invoice and on material
2	TPNODL material code and material description shall be mentioned in invoice and on material.
3	"Property of TPNODL" shall be embossed on material.
4	The material shall be properly sealed and packed in standard packing as per purchase order terms & conditions.
5	The weight and quantity of material shall be mentioned wherever applicable
6	The material supplied shall be co-related with the packing list.
7	The name plate detail on equipment shall include Material code, Material description, specification detail of material [as applicable], Serial No. Year of manufacturing, PO/RO no. and date, "PROPERTY OF TPNODL", Guarantee period and Associate's name.
8	In case of manual unloading, supplier / transporter shall deploy sufficient Labour for unloading the material at TPNODL central store. For heavy item(s), crane shall be arrange by the BA. However, in case, BA is not able to arrange the Crane, then TPNODL reserve the rights to hire the crane from market/ within internal resources and all expenditure/ unloading shall be recovered from BA.
9	The driver should have valid License and one helper in truck. All the documents of truck like registration papers, PUC etc. should be available in Truck.
10	BA representative should accompany the material and get it unloaded / stacked in his presence wherever possible.

13.0 GUARANTEE

13.1 Guarantee of Performance

Associates shall stand guarantee that the equipment and material supplied under the contract is free from design, manufacturing, material, construction, erection & installation and workmanship & quality defects and is capable of its due, rated and intended quality

Approved Copy of GCC (TPNODL)-Rev01

Doc. Title	GENERAL CONDITIONS OF CONTRACT FOR SUPPLY ORDERS	
Rev. No	01 dtd 01.12.2021	Page 16 of 47

performance, as an integrated product delivered under the contract, for a specific period termed as Guarantee Period(as elaborated elsewhere in this clause). The Associate should also guarantee that the equipment/material is new and unused except for the usage required for the tests and checks required as part of quality assurance.

13.2 Guarantee Period

The Guarantee Period will be equipment/service/work specific and shall be as specified in the Standard Specifications of TPNODL for the equipment/material/service/work and where standard specifications are not part of contract documents or guarantee period is not specified in the standard specifications,, the guarantee period shall be as per the Special Terms and Conditions of the Contract. In case of no mention of the guarantee period in standard specifications or SCC Guarantee Period will be 12 Months from the Date of Commissioning or 24 months from the date of delivery of final lot of supplies made, whichever is earlier.

13.3 Failure in Guarantee Period (GP)

If the equipment and material supplied under the contract fails to perform its due, rated & intended quality performance, during the Guarantee period, the associate is liable to undertake repair/rectify/replace the equipment and material supplied within time frame specified in the SCC or elsewhere in the contract documents at associate's cost to make the equipment and material supplied/service or work rendered under the contract of performing its due, rated and intended quality performance. If Associate fails to repair/rectify/replace the equipment or material supplied rendered under the contract, failed in Guarantee Period, TPNODL will be at liberty to get the same done at Associate's risks and costs and recover all such expenses plus the TPNODL's own charges (@ 20% of expenses incurred), from the Associate or from the "Security cum Performance Deposit" as the case may be.

If during the Warranty/ Guarantee period some parts of the supplies are replaced owing to the defects/ damages under the Warranty, the Warranty period for such replaced parts shall be until the expiry of twelve months from the date of such replacement or renewal or until the end of original Guarantee period, whichever is later.

Any repairs during the Guarantee Period shall be carried out by the Associate within 30 days of reporting the issue to Associate by TPNODL. However, if replacement of the Equipment is required, Associate shall notify the same to TPNODL within 7 days of reporting the issue by TPNODL. Thereafter, the total time for supply of new equipment/ material shall be equal to the original delivery period of that equipment/ material as specified in the Contract. In case the Associate is not able to rectify/ replace the faulty equipment/ material within the stipulated timelines as mentioned above, penalty shall be levied as per the Liquidated Damages clause mentioned in this document. The penalty amount shall be recovered from the payment due to the vendor or by encashment of the SPBG as the case may be.

13.4 Cost of repairs on failure in GP

The cost of repairs/rectification/replacement, required transportation, site inspection /mobilization/dismantling and re-installation costs as applicable, to be borne by Associate. The Associate has to ensure that the interruption in the usage of intended purpose of the equipment is minimized to the maximum extent In lieu of the time taken for repairs/rectification/replacement.

Doc. Title	GENERAL CONDITIONS OF CONTRACT FOR SUPPLY ORDERS	
Rev. No	01 dtd 01.12.2021	Page 17 of 47

13.5 Guarantee period for Goods Outsourced

If the Associate outsources partly equipment/materials/services from third party as mutually agreed upon at the pre award stage of contract, TPNODL shall have the benefit of any additional guarantee period if provided by the third party for the part supplied/executed by them.

13.6 Latent Defect

Hidden defects in manufacturing or design of the product supplied and which could not be identified by the tests conducted but later manifested during operation of the equipment are termed as latent defects. Associates shall further be responsible for 'free replacement' for another period of THREE years from the end of the guarantee period for any 'Latent Defects' if noticed and reported by the Company.

13.7 Support beyond the Guarantee Period

The Associate shall ensure availability of spares and necessary support for a period of atleast 10 years post completion of guarantee period of equipment supplied against the contract.

14.0 LIQUIDATED DAMAGES

- a) For supplies which are of standalone use, multiple in quantities and having a single final delivery schedule, Liquidated damages shall be levied without prejudice to any of the other contractual rights of TPNODL, as described below:

For delay of each week and part thereof from the delivery schedule specified in the contract, 1% of contract value corresponding to undelivered quantity, provided full quantity is supplied within 130% of the original contract time. If full contractual quantity is not delivered within 130% of contract time for delivery, TPNODL has the right to levy LD on the entire contract value, subject to a maximum of 10% of the total contract value.

- b) For Supplies having phased delivery schedule as per contract terms, standalone use and multiple in quantities, Liquidated damages shall be levied without prejudice to any of the other contractual rights of TPNODL, as described below:

For the purpose of calculating and applying LD, each delivery lot shall be considered separately. For delay of each week and part thereof, from the delivery schedule specified for the lot, 1% of the contract value corresponding to the undelivered quantity of the lot subject to a maximum of 10% of the total contract value of the subject lot. However, if full contractual quantity is not delivered within 130% of contract time for delivery, TPNODL has the right to levy LD on the entire contract value, subject to a maximum of 10% of the total contract value. Deduction of LD shall be on landed cost i.e contract value inclusive of taxes and in pursuant statutory compliance GST would be applicable at the stipulated rate and the same shall be borne by Business Associate. In case of LD deduction, a GST invoice shall be issued by TPNODL as a proof of deduction/ recovery.

14.1 LD Waiver Request

Any request of LD waiver shall be submitted within thirty (30) days of deducting LD. Request submitted beyond the timeline shall not be entertained.

15.0 UNLAWFUL ACTIVITIES

The Associate shall have to ensure that none of its employees are engaged in any unlawful activities (whether covered under the scope of the present GCC or not) subversive of the

Doc. Title	GENERAL CONDITIONS OF CONTRACT FOR SUPPLY ORDERS	
Rev. No	01 dtd 01.12.2021	Page 18 of 47

TPNODL's interest failing which appropriate action (legal or otherwise) may be taken against the Associate by the TPNODL, in accordance with the terms of the present GCC.

16.0 CONFIDENTIALITY

Associate and its employees or representatives thereof shall strictly maintain the confidentiality of various information they come across while executing the contract as detailed below.

16.1 Documents

All maps, plans, drawings, specifications, schemes and other documents or information related to the Contract/Project and the subject matter contained therein and all other information given to the Associate by the TPNODL in connection with the performance of the contract shall be held confidential by the Associate and shall remain the property of the TPNODL and shall not be used or disclosed to third parties by the Associate for any purpose other than for which they have been supplied or prepared. The Associate may disclose to third parties, upon execution of confidentiality agreements, such part of the drawings, specifications or information if such disclosure is necessary for the performance of the Work provided such third parties agree in writing to keep such information confidential to the same extent and degree as provided herein, for the benefit of the TPNODL.

16.2 Geographical Data

Maps, layouts and photographs of the unit/plant including its surrounding regions showing vital installation for national security of country or those of TPNODL shall not be published or disclosed to the third parties or taken out of the country without prior written approval of the TPNODL and upon execution of confidentiality agreements satisfactory to the TPNODL with such third parties prior to disclosure.

16.3 Associate's Processes

Title to secret processes if any developed by the Associate on an exclusive basis and employed in the design of the equipment shall remain with the Associate. TPNODL shall hold in confidence such processes and shall not disclose such processes to the third parties without prior approval of the Associate and execution by such third parties of secrecy agreements satisfactory to the Associate prior to disclosure. Upon completion of contract, such processes shall become the property of the TPNODL. Title to technical specifications, drawings, flow sheets, norms, calculations, diagrams, interpretations of test results, schematics, layouts and such other information, which the Associate has supplied to the TPNODL under the Contract shall be passed on to the TPNODL. The TPNODL shall have the right to use these for construction, erection, start-up, Trial Run, operation, maintenance, modifications and/or expansion of the works including for the manufacture of spare parts.

16.4 Exclusions

The provision of Clauses 16.1 to 16.3 shall not apply to information:

- Which at the time of disclosure are in the public domain which later on become part of public domain through no fault of the party concerned, or
- Which were in the possession of the party concerned prior to disclosure to him by the other party, or
- Which were received by the party concerned after the time of disclosure without restriction on disclosure or use, from a third party who did not acquire such information

Doc. Title	GENERAL CONDITIONS OF CONTRACT FOR SUPPLY ORDERS	
Rev. No	01 dtd 01.12.2021	Page 19 of 47

directly or indirectly from the other party or has no obligation of confidentiality for such information.

16.5 Violation

In case of violation of this clause, the Associate is liable to pay compensation and damages as may be determined by the competent authority of TPNODL.

17.0 INTELLECTUAL PROPERTY RIGHTS

If, in the course of performance of its functions and duties as envisaged by the scope of the present GCC, the Associate acquires or develops, any unique knowledge or information which would be covered, or, is likely to be covered within the definition of a trademark, copyright, patent, business secret, geographical indication or any other form of intellectual property right, it shall be obliged, under the terms of this present GCC, to share such knowledge or information with the TPNODL. All rights, with respect to, or arising from such intellectual property, as afore mentioned, shall solely vest in TPNODL.

Moreover, the Associate undertakes not to breach any intellectual property right vesting in a third party/parties, whether by breach of statutory provision, passing off, or otherwise. In the event of any such breach, the Associate shall be wholly liable to compensate, indemnify or make good any loss suffered by such third party/parties, or any compensation/damages arising from any legal proceeding/s, or otherwise. No liability of TPNODL shall arise in this respect, and any costs, damages, expenses, compensation payable by TPNODL in this regard to a third party/parties, arising from a legal proceeding/s or otherwise, shall be recoverable from the Associate.

18.0 INDEMNITY

The Associate shall at all times indemnify, keep indemnified and hold harmless the TPNODL and its officers, directors, employees, affiliates, agents, successors and assigns against all actions, claims, demands, costs, charges and expenses arising from or incurred by reason of any infringement of patent, trade mark, registered design, copy rights and/or industrial property rights by manufacture, sale or use of the equipment supplied by the Associate whether or not the TPNODL is held liable for by any court judgement. In this connection, the TPNODL shall pass on all claims made against him to the Associate for settlement.

The Associate assumes responsibility for and shall indemnify and save harmless the TPNODL from all liability, claims, costs, expenses, taxes and assessments including penalties, punitive damages, attorney's fees and court costs which are or may be required to be paid by the TPNODL and its officers, directors, employees, affiliates, agents, successors and assigns arising from any breach of the Associate's obligations under the Contract or for which the Associate has assumed responsibilities under the Contract including those imposed under any local or national law or laws, or in respect to all salaries, wages or other compensation for all persons employed by the Associate or his Sub-Associates or suppliers in connection with the performance of any work covered by the Contract. The Associate shall execute, deliver and shall cause his Sub-Associate and suppliers to execute and deliver, such other further instruments and to comply with all the requirements of such laws and regulation as may be necessary there under to conform and effectuate the Contract and to protect the TPNODL.

The TPNODL shall not be held responsible for any accident or damages incurred or claims arising, due to the Associate's error there from prior to completion of work. The Associate shall be liable for such accidents and after completion of work for such accidents as the case may be

Doc. Title	GENERAL CONDITIONS OF CONTRACT FOR SUPPLY ORDERS	
Rev. No	01 dtd 01.12.2021	Page 20 of 47

due to negligence on his part to carry out Work in accordance with Indian laws and regulations and the specifications set forth herein.

19.0 LIABILITY & LIMITATIONS

19.1 Liability

Except for any specific liability which may be identified in the Contract and which may be payable hereunder, Associate shall not be liable for any special, incidental, indirect, or consequential Damages or any loss of business Contracts, revenues or other financial loss (or equivalents thereof no matter how claimed, computed or characterized) arising out of or in connection with the Performance of the Work or supply of Goods ***unless caused by Associate's negligence, willful misconduct or breach of contract.***

If the Associate is a joint venture or consortium, all concerned parties shall be jointly and severally bound to the TPNODL for the fulfillment of the provisions of the Contract. The consortium or the joint venture shall designate one party as their leader, who will be the coordinator between the parties and TPNODL. The constituents & leader of the consortium or joint venture shall not be changed without the prior consent of TPNODL.

TPNODL shall have no liability or any special, incidental, indirect or consequential Damages for any loss of Business Contracts, revenues or other financial loss arising out of this Contract.

19.2 Limitation of Liability

The total liability of Associate against any contract shall be limited to the Total All Inclusive Contract Value.

20.0 FORCE MAJEURE

Force Majeure applies if the performance by either Party ("the Affected Party") of its obligations under Contract is materially and adversely affected.

"Force Majeure" shall mean any event or circumstance or combination of events or circumstances referred below and their consequences that wholly or partly prevents or unavoidably delays any Party in the performance of its obligations under this Agreement, but only and to the extent that such events and circumstances are not within the reasonable control, directly or indirectly, of the Affected Party and could not have been avoided even if the Affected Party had taken reasonable care:

- Act of war (whether declared or undeclared), invasion, armed conflict or act of foreign enemy, embargo, blockade, revolution, riot, bombs, religious strife or civil commotion, etc. ▪ Politically motivated sabotage, or terrorism, etc.
- Action or Act of Government or Governmental agency for which remedy is beyond the control of the affected parties. ▪ Any act of God.

Note: Causes like power breakdown/ shortages/fire/strikes, accidents etc do not fall under Force Majeure.

Time being the essence of the Contract, if either party is prevented from the performance of its obligations in whole or in part due to an event of Force Majeure, then provided Notice of happening of any event by the Affected Party is given to the other party within seven (7) days from the date of occurrence of such event, which DIRECTLY has impact on works and submitted details and quantum of resulting effect, but at the same time had made all possible efforts to mitigate and overcome effects thereof, the Affected Party's performance under this

Doc. Title	GENERAL CONDITIONS OF CONTRACT FOR SUPPLY ORDERS	
Rev. No	01 dtd 01.12.2021	Page 21 of 47

Contract shall be suspended until such event ceases and the Scheduled Completion shall be delayed accordingly.

If Force Majeure event(s) continue for a period of more than three months, the parties shall hold consultation to discuss the further course of action.

Neither party shall be considered to be in default or in breach of its obligation under the Contract to the extent that performance of such obligation by either party is prevented by any circumstances of Force Majeure which arise after effective date of Contract.

Neither party can claim any compensation from the other party on account of Force Majeure.

21.0 SUSPENSION OF CONTRACT

21.1 Suspension for Convenience

TPNODL may, at any time and at its sole option, suspend execution of all or any portions of the schedule of items of contract to be supplied/work to be executed by Associate under the contract by providing to the Associate at least two business days written notice for contracts having contract completion period less than sixty days and at least seven business days' notice for all other contracts.

Upon receipt of any such notice, the Associate shall respond as follows as applicable as per contract construction.

- Immediately discontinue further supply of material/goods specified in the suspension notice for supply contracts
- Immediately discontinue further service/work and supply of materials of those services/materials/work specified in the suspension notice for service /composite contract
- Promptly make every reasonable effort to obtain suspension, upon terms satisfactory to TPNODL, of all orders, outsourcing arrangements, and rental Contracts to the extent that they relate to performance of the portion of Work suspended by the notice.
- Protect and maintain the portion of the service/Work already completed, including the portion of the Work suspended hereunder, unless otherwise specifically stated in the notice.
- Continue delivering/carrying out the supply/service/work items as per contract conditions, which do not fall under purview of the suspension notice.

On receipt of resumption notice from TPNODL, the Associate shall resume execution of contract as specified in the resumption notice, within the time frame specified in the resumption notice.

21.2 Suspension for Breach of Contract conditions.

TPNODL shall suspend execution of whole/or part thereof the contract till such time Associate complies with the conditions stipulated under section clause 22.1 for breach/default of contract conditions.

21.3 Compensation in lieu of Suspension

If the suspension of the contract in whole or in part is for convenience of TPNODL and not due to any breach of contract conditions by the associate, TPNODL at its discretion shall consider compensating all reasonable additional costs incurred by Associate in lieu of suspension of

Doc. Title	GENERAL CONDITIONS OF CONTRACT FOR SUPPLY ORDERS	
Rev. No	01 dtd 01.12.2021	Page 22 of 47

whole or part of contract, on representation of the Associate providing justified estimates of such additional costs and such estimates are found acceptable and approved by competent authority of TPNODL.

If the suspension of contract in whole or part thereof is due to breach of contract conditions (refer clause 22.1) by the Associate, Associate shall not be entitled for any compensation for any cost incurred in lieu of suspension of whole or part of contract and also shall be liable for compensating all the losses arising to TPNODL in lieu of suspension of contract. Resumption notice shall be subject to the Associate taking corrective action for the breach of contract conditions within the time frame and as per the terms specified in the suspension notice.

22 TERMINATION OF CONTRACT

22.1 Termination for Default/Breach of Contract

The contract / PO /RC shall be subject to termination by TPNODL in case of breach of the contract by the Associate which shall include but not be limited to the following:

- a. Withdrawal or intimation by the Associate of its intent to withdraw or surrender the execution / completion of the contracted work /PO or failure in ensuring adherence to any delivery schedules, in deviation of the contract/PO.
- b. Refusal or neglect on the part of the Associate to supply material/equipment of quantity or quality as specified by TPNODL and within the timeframe as specified in the contract document or refusal or neglect to execute the services/work in terms of the agreed standards of quantity or quality and/or within the timeframe specified in the contract/PO.
- c. Failure in any respect to perform any portion of the Work contracted with promptness, diligence, or in accordance with the terms of the contract.
- d. Failure to furnish guarantees as specified and /or failure to comply with the terms thereof.
- e. Failure to furnish such relevant documents or information within the time specified which may be necessary for due execution / completion of the works and documentation.
- f. Liquidation, bankruptcy either voluntary or involuntary OR entering into any composition or compromise with its creditors, or Insolvency.
- g. In case any reasonable information has been received by TPNODL that Associate has adopted/ or attempted to adopt any unethical conduct, action in award of the contract /PO or at any time thereafter.
- h. Failure to comply with applicable statutory provisions as contained in the contract or failure to comply with the applicable laws.
- i. Failure to comply with safety regulations/clauses stipulated in the contract or as may be generally instructed by TPNODL.

If the default or breach as specified under clause 22 (except sub clause g thereof) be committed by the associate for the first time, TPNODL shall issue, along the with notice of default or breach, a warning notice instructing the associate to take remedial/corrective action within the time frame stipulated in the warning notice and not to repeat the same in future. The timeframe for corrective action by the associate shall be specific to the nature of breach of contract and the same shall not be objected to by the Associate. If the Associate fails to comply with the instructions in the warning notice or in taking corrective action to the satisfaction of

Doc. Title	GENERAL CONDITIONS OF CONTRACT FOR SUPPLY ORDERS	
Rev. No	01 dtd 01.12.2021	Page 23 of 47

TPNODL then TPNODL may terminate the entire or part of contract at its discretion by issuing termination notice without incurring any liability on this ground.

In case the contract is terminated for any breach of the nature specified in clause 22 g stated above, TPNODL shall have the right to terminate all the contracts TPNODL is having with the Associate by issuing termination notice which shall be without prejudice to the other rights of TPNODL available to it under law.

Without prejudice to its right to terminate for breach of contract, TPNODL may, without assigning any reason, terminate the Contract in whole or in part at any time at its discretion while the contract is in force by serving a written notice of two weeks to the Associate.

In the event of TPNODL having proceeded with termination of the contract the associate shall comply and proceed further in the following manner:

- a) Associate shall discontinue the supply, on the expiry of the said period of two weeks.
- b) Associate shall ensure that no further steps are being taken towards discharge of the obligations, terms and conditions as contained in the contract/PO. This shall include initiation of actions not limited to discontinuation of other allied and associated arrangements which the associate might have entered into with third parties for due discharge of its obligations under the contract with TPNODL.
- c) The Associate shall perform thereafter such tasks as may be necessary to preserve and protect the terminated portion of the material/service/work in progress and the materials and equipment at TPNODL sites or in transit thereto. However the associate shall continue to fulfill its contractual obligations with regard to the part of contract not terminated.
- d) It shall be open for TPNODL to conduct a joint assessment with the associate of the material, supplies, equipment, works or in general as to the subject matter of the contract in regard to which the associate claims having completed its obligations before or during such termination.
- e) It shall be open to TPNODL to seek invocation of the performance bank guarantee or any other guarantee or other security deposit by whatever name called submitted by the associate, which shall not be objected to or protested against by the associate.

In case of termination of the contract the parties agree to be governed inter alia by the following:

- a) In case TPNODL exercises its right of termination as stated above the associate shall not dispute or object to the same.
- b) The Associate shall be entitled to receive and claim only such payments OR sums of money from TPNODL as may be found payable to it in regard to works executed by it under the terms of the contract and no other claim of any nature whatsoever shall be made by the Associate.
- c) All such provisions which the parties have agreed to survive and prevail even after termination of the contract shall remain effective despite the termination.

In the event of such termination, TPNODL may finish the Work by whatever method it may deem expedient, including the hiring of services and /or purchase of material equipment from such third parties as TPNODL may deem fit or may itself provide any labor or materials and

Doc. Title	GENERAL CONDITIONS OF CONTRACT FOR SUPPLY ORDERS	
Rev. No	01 dtd 01.12.2021	Page 24 of 47

perform any part of the Work. The associate undertakes to bear the incremental costs if any paid by TPNODL in such a case attributable to failure on the part of the associate. The Associate in such a case shall not be entitled to receive any further payments and any sums found payable to it may be adjusted by TPNODL against the amount recoverable from him on this ground. The same shall be without prejudice to other rights available to TPNODL under law against the associate.

Upon the termination of any of the contract due to occurrence of any circumstances provided in clauses stated above and constituting repeated breach or misconduct, TPNODL shall be entitled to bar the associates its agents, affiliates from undertaking any negotiation / tendering, bidding, participation activities concerning TPNODL for a period of two years from date of such termination. The same shall be without prejudice to other rights available to TPNODL.

22.2 Termination for Convenience of Associate

Associate at its convenience may request for termination of contract, clearly assigning the reason for such request. TPNODL has full right to accept, reject or partially accept such request. However, associate shall continue its supply as per contract till final approval is given to associates for such termination.

22.3 Termination for Convenience of TPNODL

TPNODL at its sole discretion may terminate the contract by giving 30 days prior notice in writing or through email to the Associate. TPNODL shall pay the Associate for all the supplies/ services rendered till the actual date of contract termination against submission of invoice by the Associate to that effect.

23.0 DISPUTE RESOLUTION & ARBITRATION

In case of any dispute or difference the parties shall endeavour to resolve the same through conciliatory and amicable measures within 15 Days failing which the matter may be referred by either party for resolution by the sole arbitrator to be appointed mutually by both the parties. The arbitral proceedings shall be conducted in accordance with Arbitration and Conciliation Act 1996 and the place of arbitration shall be Bhubaneswar. The language to be used at proceedings shall be English and the award of the arbitrator shall be final and binding on the parties. The parties shall bear their respective costs of arbitration. The associate shall continue to discharge its obligations towards due performance of the works as per the terms of the contract during the arbitration proceedings unless otherwise directed in writing by TPNODL or suspended by the arbitrator. Further, TPNODL shall continue making such payments as may be found due and payable to the associate for such works.

23.1 Governing Laws and Jurisdiction

The parties shall be subject to the jurisdiction of the courts of law in Bhubaneswar and any matter arising here from shall be subject to applicable law in force in India.

24.0 ATTRIBUTES OF GCC

24.1 Cancellation

The Company reserves the right to cancel, add, delete at its sole discretion, all or any terms of this GCC or any contract, order or terms agreed between the parties in pursuance without assigning any reasons and without any compensation to the Associates.

Doc. Title	GENERAL CONDITIONS OF CONTRACT FOR SUPPLY ORDERS	
Rev. No	01 dtd 01.12.2021	Page 25 of 47

24.2 Severability

If any portion of this GCC is held to be void, invalid, or otherwise unenforceable, in whole or part, the remaining portions of this GCC shall remain in effect.

24.3 Order of Priority

In case of any discrepancies between the stipulations in General Conditions of the Contract (GCC) and Special Conditions of Contract (SCC), the GCC shall stand superseded by the SCC to the extent stipulated hereinabove while balance portion of respective clauses of GCC shall continue to be applicable.

25.0 ERRORS AND OMISSIONS

The Associate shall be responsible for all discrepancies, errors and omissions in the drawings, documents or other information submitted by him, irrespective of whether these have been approved, reviewed or otherwise accepted by the TPNODL or not. However any error in design/drawing arising out of any incorrect data/written information from TPNODL will not be considered as error and omissions on part of the Associate.

26.0 TRANSFER OF TITLES

The title of ownership and property to all equipment, materials, drawings & documents shall pass to the TPNODL on acceptance of material by store/site after Inspection.

However, such passing of title of ownership and property to the TPNODL shall not in any way absolve, dilute or diminish the responsibility and obligations of the Associate under this Contract including loss or damages and all risks, which shall vest with the Associate.

27.0 INSURANCE

The Contractor shall take out the Insurance Policies which shall cover all risks including the following, as applicable:-

- a) The value of the policy shall cover the total value of all the items till they are handed over to TPNODL.
- b) TPNODL shall be the principal holder of the policy. The Associate shall be the loss payee under the policy. Associate / Sub-contractor of the Associate shall not be holders or beneficiaries in the policy nor shall they be named in the policy. TPNODL reserves the exclusive right to assign the policy.
- c) While the payment of premium may be phased in agreement with the insurance company, at no time shall goods and services required to be provided by the associate shall remain uninsured in accordance with (a) above.
- d) A copy of the Insurance policy shall be made available to TPNODL prior to first dispatch lot of any Equipment and policy shall be kept alive and valid at all times up to the stage of final acceptance.
- e) TPNODL reserves the right to take out whatever policy that is deemed necessary by him if the associate fails to keep the said policy alive and valid at all times and/or causes lapses in payment of premium thereby jeopardizing the said policy. The cost of such policy(s) shall be recovered / deducted from the amount payable to the associate.

Doc. Title	GENERAL CONDITIONS OF CONTRACT FOR SUPPLY ORDERS	
Rev. No	01 dtd 01.12.2021	Page 26 of 47

- f) The policy shall ensure that the TPNODL's decision regarding replacement of goods damaged, lost or rendered unusable shall be final.

In all cases, the associate shall lodge the claims with the underwriters and also settle the claims and shall also notify TPNODL of any filed claims. However, the associate shall proceed with the repairs and/or replacement of the equipment/components without waiting for the settlement of the claims. In case of seizure of materials by concerned authorities, the associate shall arrange prompt release against bond, security or cash as required. TPNODL, upon request by the associate, will extend all reasonable assistance to the associate in such a case.

All the insurance claims shall be processed and settled by the associate and the missing/damaged items shall be replaced/repared by them without any extra cost to TPNODL and without affecting the completion time.

28.0 SUGGESTIONS & FEEDBACK

We welcome all our Business Associates to write to us about their experience with TPNODL; be it our Company, our services or our people. Each and every concern, issue, query and suggestion from you will help us to become a better company to work with and shall help us develop a strong bonding of trust and a long term relationship with you.

You may send your feedback to HOD Contracts by filling up our Business Associate Feedback Form enclosed herewith as *Annexure-I*.

29.0 CONTACT POINTS

In case Business Associate needs information with respect to payments or has any grievances, he may contact to HoD-Contracts and Finance.

30.0 LIST OF ANNEXURES

S. No.	Subject	Annexure
1.	Performa for Bid Security Bank Guarantee	A
2.	Performa for Performance Bank Guarantee (CP cum EP)	B
3.	Performa for No Demand Certificate by Associate	C
4.	Performa For Application For Issuance of Consolidated TDS Certificate	D
5.	Business Associate Feedback Form	E
6.	Acceptance Form For Participation In Reverse Auction Event	F
7.	Form for RTGS Payment	G
8.	Vendor Appraisal Form	H
9.	Manufacturer Authorization Form	I
10.	Tata Code of Conduct	I

ANNEXURE-A

Doc. Title	GENERAL CONDITIONS OF CONTRACT FOR SUPPLY ORDERS	
Rev. No	01 dtd 01.12.2021	Page 27 of 47

PROFORMA FOR BID SECURITY BANK GUARANTEE

**TP Northern Odisha Distribution Limited
Balasore**

WHEREAS, (Name of the Bidder) _____
(hereinafter called "the BIDDER") has submitted his bid dated _____ for the
(Tender No. & Name of Contract) _____ (hereinafter
called "the BID").

KNOW ALL men by these presents we (Name of the
Bank) _____ of (Name of the
Country) _____ having our registered
office at _____ (hereinafter called "the BANK) are bound unto
TPNODL in the sum of _____ for which payment well and truly to be
made to the TPNODL the Bank binds himself, his successors and assigns by these
presents.

SEALED with the Common Seal of the said Bank this _____ day of _____ 20_____.

The CONDITIONS of this obligation are:

- i) If the Bidder withdraws his Bid during the period of bid validity specified in the Proforma of Bid or
- ii) If the Bidder having been notified of the acceptance of his Bid by the TPNODL during the period of bid validity fails or refuses to furnish the Contract Performance Bank Guarantee, in accordance with the Instructions to Bidders.

We undertake to pay the TPNODL upto the above amount upon receipt of its first written demand, provided that in its demand the TPNODL will note that amount claimed by it is due to it owing to the occurrence of one or both conditions, specifying the occurred condition or conditions.

This Guarantee will remain in force upto and including the date (No of days as mentioned in tender enquiry) days after the closing date of submission of bids as stated in the Invitation to Bid or as extended by you at any time prior to this date, notice of which extension to the Bank being hereby waived, and any demand in respect thereof should reach the Bank not later than the above date.

DATE	SIGNATURE OF THE BANK
WITNESS	SEAL

(Signature, Name & Address) (At least 2 witnesses)

ANNEXURE- B

PROFORMA FOR PERFORMANCE BANK GUARANTEE (CP cum EP)

(On Rs.100/- Stamp Paper) Note:

- a) Format shall be followed in toto
- b) Claim period of six months must be kept up

Doc. Title	GENERAL CONDITIONS OF CONTRACT FOR SUPPLY ORDERS	
Rev. No	01 dtd 01.12.2021	Page 28 of 47

- c) The guarantee to be accompanied by the covering letter from the bank confirming the signature to the guarantee

TP Northern Odisha Distribution Ltd.

Balasore

CP cum EP BG No.....

Order/Contract No.....dated.....

1. You have entered into a Contract No _____ with M/s. _____ (hereinafter referred to as "the Vendor") for the supply cum erection / civil work of _____ (hereinafter referred to as "the said Equipment") for the price and on the terms and conditions contained in the said contract.
2. In accordance with the terms of the said contract, "the Vendor" agreed to furnish you with an irrevocable, unconditional and acceptable bank guarantee for 10% of the value of contract and to be valid till the end of Guarantee period plus one month towards "Contract cum Equipment performance". For this purpose you have agreed to accept the guarantee.
3. In consideration thereof, we, _____ hereby irrevocably and unconditionally guarantee to pay to you on demand but in any case before the end of five working days from the date of the claim and without demur and without reference to "the Vendor" such amount or amounts not exceeding the sum of Rs. _____ (Rupees _____ only) being _____% (_____ percent) of the total value of the contract on receipt of your intimating that "the Vendor" has not fulfilled his contractual obligations. You shall be the sole judge for such non-fulfillment and "the Vendor" shall have no right to question such judgment.
4. You shall have the right to file / make your claim on us under the guarantee for a **further period of one month** from the date of expiry.
5. This guarantee shall not be revoked without express consent and shall not be affected by your granting time or any other indulgence to "the Vendor", which shall include but not be limited to, postponement from time to time of the exercise the same in you or any right which you may have against "the Vendor" and to exercise the same in any covenant contained or implied in the said contract or any other course or remedy or security available to you, and our Bank shall not be released from its obligations under this guarantee by

Doc. Title	GENERAL CONDITIONS OF CONTRACT FOR SUPPLY ORDERS	
Rev. No	0	Page 29 of 47

your exercising any of your rights with reference to matters aforesaid or any of them or by reasons of any other act or forbearance or other acts of omission or commission on your part or any other indulgence shown by you or by any other matter or thing whatsoever which under the law would, but for this provision have the effect of relieving our bank from its obligation under this guarantee.

6. We also agree that you shall be entitled at your option to enforce this guarantee against our bank as a principal debtor, in the first instance, notwithstanding any other security or guarantee that you may have in relation to "the Vendor's" liabilities in respect of the premises
7. This guarantee shall not be affected by any change in the constitution of our Bank or "the Vendor" or for any other reason whatsoever.
8. Any claim / extension under the guarantee can be lodge-able at outstation banks or at Balasore branch and claim will also be payable at Balasore Branch (to be confirmed by Balasore Branch by a letter to that effect in case BG is from the branch outside Balasore).
9. Notwithstanding anything herein contained, our liability under this guarantee is limited to Rs. _____ (Rupees _____) only and the guarantee will remain in force upto and including _____ (Date) and shall be extended from time to time for such period or period as may be desired by "the Vendor".
10. Unless a demand or claim under this guarantee is received by us in writing within six months from _____ (expiry date) i.e. on or before _____ (claim period end date), we shall be discharged from all liabilities under this guarantee thereafter.

Dated at _____ this _____ day of _____ 20__

Bank's rubber stamp

1. Banks full address

Designation of Signatory

2. Bank official number

Doc. Title	GENERAL CONDITIONS OF CONTRACT FOR SUPPLY ORDERS	
Rev. No	0	Page 30 of 47

ANNEXURE-C

PROFORMA FOR “NO DEMAND CERTIFICATE” BY ASSOCIATE

(On Company's Letter head or with Company Seal)

(To be submitted by the Associate to TPNODL Accounts Department at the time of receipt of full and final payment)

(Certificate No. CCP/002)

Name of the Project Order/

Contract No.

Dated

Name of the Associate Scheme

No. / Job No.

We, M/s. _____ (Associate) do hereby acknowledge and confirm that we have received the full and final payment due and payable to us from TPNODL, in respect of our aforesaid Order No _____ dated _____ including amendments, if any, issued by TPNODL to our entire satisfaction and we further confirm that we have no claim whatsoever pending with TPNODL under the said contract / W.O.

Notwithstanding any protest recorded by us in any correspondence, documents, measurement books and / or final bills etc., we waive all our rights to lodge any claim or protest in future under this contract.

We are issuing this “NO DEMAND CERTIFICATE” in favour of TPNODL, with full knowledge and with our free consent without any undue influence, misrepresentation, coercion etc.

Place

Name

(Company Seal)

Doc. Title	GENERAL CONDITIONS OF CONTRACT FOR SUPPLY ORDERS	
Rev. No	0	Page 31 of 47

ANNEXURE-D

**PROFORMA FOR APPLICATION FOR ISSUANCE OF CONSOLIDATED TDS
CERTIFICATE**

To be printed on the letterhead

To,
TPNODL,
Balasore

Sub: Application for issuance of Consolidated TDS Certificate for the FY _____

Dear Sir,

I / we hereby request / authorize you to issue me / us a consolidate TDS Certificate for the financial year _____ against tax deducted at source by you from my / our payments / bills during the said year from time to time under Chapter XVII – B of the Income Tax Act, 1961. For and on behalf of

Signature

Name

Address

Contact No. (Land Line)
(Mobile)

PAN #

Assessing authority

ATTACH THE COPY OF PAN CARD

Doc. Title	GENERAL CONDITIONS OF CONTRACT FOR SUPPLY ORDERS	
Rev. No	0	Page 32 of 47

ANNEXURE-E

BUSINESS ASSOCIATE FEEDBACK FORM

With an objective to improve our internal processes and systems, and serve you better, we solicit your valuable feedback & suggestions. It is estimated that it will take about 10 minutes to complete this survey. We assure you that your feedback shall be kept confidential. Please send the duly filled feedback form in the "TPNODL addressed - attached envelop"

You are associated with us as

- OEMs Service Contractor Material Suppliers Material & Manpower Supplier

You are associated with us for

- Less than 1 year More than 1 year but less than 3 years More than 3 years

Your office is located at

- Balsore Within 200 kms from Balsore More than 200 kms from Balsore

Your nearly turnover with TPNODL

- Less than 25 Lacs 25 Lacs to 1 Crore More than 1 Cr.

Additional Information

Your Name	
Your Designation	
Your Organization	
Contact Nos.	
Email	

We once again thank you for your participation in this survey. Please spare 10 minutes to give your feedback on following pages (Section A to E)

SECTION – A

(Please ✓ mark in the relevant box and give your remarks / suggestions / information for our improvement).

S. No.	Parameters	1	2	3	4	5	Remarks/ Suggestion
		Do Not Agree	Slightly in Agreement	In Fair Agreement	Mostly in Agreement	Fully Agree	
1	You receive all relevant queries / tenders from us in timely manner.						
2	We provide you enough lead time to respond to our queries / tenders.						
3	We provide you adequate support (drawings, documents, clarifications, briefing etc.) to enable you meet our requirements.						
4	All following elements of our contract / purchase order are rational :						
4.1	Scope of Work						
4.2	Delivery / Execution Schedule						
4.3	Payment Terms						
4.4	Liquidated Damages						
4.5	Performance Guarantee						
5	Our purchase orders / contracts are simple, specific & easy to understand						
6	TPNODL demonstrate willingness to be flexible in administration of Contract / Purchase Order						
7	We provide timely responses / clarifications to your queries						
8	TPNODL representative you interact / coordinate with is adequately empowered to support you in meeting contractual obligations						
9	TPNODL provide you all necessary infrastructure support for timely and quality completion of work (including AMC)						
10	TPNODL Engineer-in-Charge timely certifies the jobs executed/ material supplied						
11	TPNODL Engineer-in-Charge efficiently supervises the job execution for timely completion of job						
12	BIRD (Bill Inward Receipt Desk) initiative has improved payment disbursement process						

S. No.	Parameters	1	2	3	4	5	Remarks/ Suggestion
		Do Not Agree	Slightly in Agreement	In Fair Agreement	Mostly in Agreement	Fully Agree	
13	Our approach for Inspection and Quality Assurance effective to expedite project completion?						
14	TPNODL never defaults on contractual terms						
15	In TPNODL Contracts closure is done within set time limit						
16	Our material receiving procedures are well defined and efficiently deployed to reduce mutual inconvenience						
17	Bank Guarantees are released in time bound manner						
18	Our processes related to payment / account settlement are effective.						
19	You get payments on time						
20	TPNODL Employees follow Ethical behaviour						

GENERAL CONDITIONS OF CONTRACT

SECTION – B

SECTION – B (Please rate the following parameters on a scale of 1 to 5, where 1 - Minimum; 5 - Maximum)

S. No.	Parameters	1	2	3	4	5	Remarks/ Suggestion
1	How do you rate courtesy/ empathy/ attitude level and warmth of TPNODL employees you interact with from following team?						
1.1	Project Engineering						
1.2	District / Zones						
1.3	Projects/HOG (TS &P)						
1.4	Inspection & Quality Assurance						
1.5	Stores						
1.6	Metering & Billing						
1.7	Accounts / Finance						
1.8	Administration						
1.9	IT & Automation						
2	How would you rate TPNODL in comparison to your other clients in terms of fairness of treatment and transparency with its Business Associates?						
3	How would you rate TPNODL in comparison to your other clients in terms of processes and systems to manage partnership with its Business Associates						
4	How would you rate TPNODL in comparison to your other clients in terms of building long term & mutually relationship with its Business Associates						

SECTION – C

Please ✓ mark in the relevant box and give your remarks / suggestions / information for our improvement.

S. No.	Parameters	Certainly No	Probably No	Certainly Yes	Probably Yes	Remarks/ Suggestion
1	Based on your experience with TPNODL, would you like to continue your relationship with TPNODL?					
2	If someone asks you about TPNODL, would you talk “positively” about					

	TPNODL?					
3	Would you refer TPNODL name to others in your community, fraternity and society as a professional & dynamic organization?					

SECTION - D

If we ask you to rate us on a scale of 1 to 10, how will you rate TPNODL, that truly represents your overall satisfaction with us (please tick appropriate box) -

1	2	3	4	5	6	7	8	9	10
---	---	---	---	---	---	---	---	---	----

SECTION - E

Please ✓ mark in the relevant box and give your remarks / suggestions / information for our improvement.

Please spare your thoughts for TPNODL's improvement in particular areas of weaknesses, particularly relating to some great practices, attitudes that you have seen elsewhere in Indian and International Organizations, which you recommend TPNODL to adopt. Please give your valuable salient recommendations.

Please spare your thoughts for TPNODL's improvement in particular areas of major concerns for you. We also welcome your suggestions to adopt any best practices, attitudes that you

Recommendation	<i>Please tick (✓) your top 5 expectations out of the following 10 points listed below -</i>	
(Please list down improvement you expect from TPNODL)	<i>Timely payment</i>	
1	<i>Flexibility in Contracts/PO</i>	
	<i>Clarity in PO,s & Contracts</i>	
2	<i>Timely response to quarries</i>	
	<i>Timely certification of works executed</i>	
3	<i>Clarity in Specs, drawings, other docs etc.</i>	
	<i>Adequate information provided on website for tender notification, parties qualified etc.</i>	
4	<i>Timely receipt of material at site for execution</i>	
	<i>Performance Guarantee/EMD released in time</i>	

Doc. Title	GENERAL CONDITIONS OF CONTRACT FOR SUPPLY ORDERS	
Rev. No	0	Page 37 of 47

5	<i>Inspection & quality assurance support for timely job completion</i>
---	---

We thank you for your time and courtesy!!

ANNEXURE-F

ACCEPTANCE FORM FOR PARTICIPATION IN REVERSE AUCTION EVENT

(To be signed and stamped by the bidder prior to participation in the auction event)

In a bid to make our entire procurement process more fair and transparent, TPNODL intends to use the reverse auctions through ARIBA tool as an integral part of the entire tendering process. All the bidders who are found as technically qualified based on the tender requirements shall be eligible to participate in the reverse auction event.

The following terms and conditions are deemed as accepted by the bidder on participation in the bid event:

1. TPNODL shall provide the user id and password to the authorized representative of the bidder. (Authorization Letter in lieu of the same shall be submitted along with the signed and stamped Acceptance Form).
2. TPNODL will make every effort to make the bid process transparent. However, the award decision by TPNODL would be final and binding on the supplier.
3. The bidder agrees to non-disclosure of trade information regarding the purchase, identity of TPNODL, bid process, bid technology, bid documentation and bid details.
4. The bidder is advised to understand the auto bid process to safeguard themselves against any possibility of non-participation in the auction event.
5. In case of bidding through Internet medium, bidders are further advised to ensure availability of the entire infrastructure as required at their end to participate in the auction event. Inability to bid due to telephone line glitch, internet response issues, software or hardware hangs, power failure or any other reason shall not be the responsibility of TPNODL.
6. In case of intranet medium, TPNODL shall provide the infrastructure to bidders. Further, TPNODL has sole discretion to extend or restart the auction event in case of any glitches in infrastructure observed which has restricted the bidders to submit the bids to ensure fair & transparent competitive bidding. In case an auction event is restarted, the best bid as already available in the system shall become the start price for the new auction.
7. In case the bidder fails to participate in the auction event due any reason whatsoever, it shall be presumed that the bidder has no further discounts to offer and the initial bid as submitted by the bidder as a part of the tender shall be considered as the bidder's final no regret offer. Any offline price bids received from a bidder in lieu of non-participation in the auction event shall be out rightly rejected by TPNODL.
8. The bidder shall be prepared with competitive price quotes on the day of the bidding event.
9. The prices as quoted by the bidder during the auction event shall be inclusive of all the applicable taxes, duties and levies and shall be FOR at TPNODL site.
10. The prices submitted by a bidder during the auction event shall be binding on the bidder.
11. No requests for time extension of the auction event shall be considered by TPNODL.
12. The original price bids of the bidders shall be reduced on pro-rata basis against each line item based on the final all inclusive prices offered during conclusion of the auction event for arriving at Contract amount.

Signature & Seal of the Bidder

ANNEXURE-G

To,

DGM (Finance)
TPNODL
Balasore

Sub: **e-Payments through National Electronic Fund Transfer (NEFT) OR Real Time Gross Settlement System (RTGS)**

Dear Sir,

We request and authorize you to affect e-payment through NEFT/RTGS to our Bank Account as per the details given below:-

Vendor Code :

Title of Account in the Bank :

Account Type :

(Please mention here whether account is Savings/Current/Cash Credit)

Bank Account Number :

--	--	--	--	--	--	--	--	--	--	--	--	--	--	--	--	--	--	--

Name & Address of Bank :

Bank Contact Person's Names :

Bank Tele Numbers with STD Code :

Bank Branch MICR Code :

--	--	--	--	--	--	--	--	--	--	--	--	--	--	--	--	--	--	--	--	--

(Please enclose a Xerox a copy of a cheque. This cheque should not be a payable at par cheque)

Bank Branch IFSC Code :

--	--	--	--	--	--	--	--	--	--	--	--	--	--	--	--	--	--	--	--	--	--	--

(You can obtain this from branch where you have your account)

Email Address of accounts person: :
(to send payment information)

Doc. Title	GENERAL CONDITIONS OF CONTRACT FOR SUPPLY ORDERS	
Rev. No		Page 39 of 47

Name of the Authorized Signatory: _____ :

Contact Person's Name:

Official Correspondence Address:

We confirm that we will bear the charges, if any, levied by our bank for the credit of NEFT/RTGS amounts in our account. Any change in above furnished information shall be informed to TPNODL well in time at our own. Further, we kept TPNODL indemnified for any loss incurred due to wrong furnishing of above information.

Thanking you,

For _____

(Authorised Signatory)

(Signature with Rubber Stamp)

Certification from Bank:

We confirm that we are enabled for receiving NEFT/RTGS credits and we further confirm that the account number (specify Bank a/c no.) of (Please mention here name of the account holder), the signature of the authorised signatory and the MICR and IFSC Code of our branch mentioned above are correct.

This also is certified that the above information is correct as per Bank record

(Manager's/ Officers Signature under Bank Stamp)

Doc. Title	GENERAL CONDITIONS OF CONTRACT FOR SUPPLY ORDERS	
Rev. No		Page 40 of 47

ANNEXURE-H
VENDOR APPRAISAL FORM

TO BE SUBMITTED BY VENDOR (To be filled as applicable)			
Part A			
1.0	DETAILS OF THE FIRM		
	1.1	NAME (IN CAPITAL LETTERS)	
	1.2	TYPE OF CONCERN (PROPRIETARY) PARTNERSHIP PVT.LTD., PUBLIC LTD. ETC.	
	1.3	YEAR OF ESTABLISHMENT	
	1.4	LOCATION OF OFFICE POSTAL ADDRESS	
	1.5	CONTACT DETAIL OF BA's REPRESENTATIVE NAME E-MAIL ID CELL NO.	
	1.6	LOCATION OF MANUFACTURING UNITS	:
		i) UNITS 1	:
		ii) OTHER UNITS	:
2.0	PRODUCTS / SERVICES BEING OFFERED		
3.0	TURNOVER DURING THE LAST 3 YEARS (TO BE VERIFIED WITH THE LATEST PROFIT & LOSS STATEMENT).		
4.0	AVAILABILITY OF STATUTORY DOCUMENTS I.E. COPY OF PAN CARD		
5.0	AVAILABILITY OF STATUTORY DOCUMENTS I.E. COPY OF GST REGISTRATION		
6.0	APPLICABILITY UNDER MSME CERTIFICATION		
7.0	BA BELONGS TO AA COMMUNITY (SC/ST)		
8.0	DOCUMENTS VERIFYING ADDRESS PROOF (SUPPORTED BY ANY GOVT. ISSUED DOCUMENT)		

9.0	TECHNICAL		
	9.1	NO.OF DESIGN ENGINEERS (INDICATE NO.OF YEARS EXPERIENCE IN RELATED FIELDS)	:
	9.2	NO.OF DRAUGHTSMEN	:
	9.3	COLLABORATION DETAILS (IF ANY)	:
		9.3.1 DATE OF COLLABORATION	:
		9.3.2 NAME OF COLLABORATOR	:
		9.3.3 RBI APPROVAL DETAILS	:
		9.3.4 EXPERIENCE LIST OF COLLABORATOR	:
		9.3.5 DURATION OF AGREEMENT	:
	9.4	AVAILABILITY OF STANDARDS / DESIGN PROCEDURES / COLLABORATOR'S / DOCUMENTS (CHECK WHETHER THESE ARE LATEST/CURRENT)	:
	9.5	TECHNICAL SUPPORT, BACK-UP GUARANTEE, SUPERVISION, QUALITY CONTROL BY COLLABORATOR (WHEREVER ESSENTIAL). (THIS CLAUSE IS RELEVANT WHEN VENDOR'S EXPERIENCE IS INADEQUATE)	:
	9.6	QUALITY OF DRAWINGS	:
10.0	MANUFACTURE		
	10.1	SHOP SPACE, LAYOUT LIGHTING, VENTILATION, ETC.	:
	10.2	POWER (KVA)	:
		MAINS INSTALLED	:
		UTILISED	:
		STANDBY POWER SOURCE	:
	10.3	MANUFACTURING FACILITIES (ATTACH LIST OF EQUIPMENTS AS APPLICABLE)	:
		10.3.1 MATERIAL HANDLING	:
		10.3.2 MACHINING	:
		10.3.3 FABRICATION	:

Doc. Title	GENERAL CONDITIONS OF CONTRACT FOR SUPPLY ORDERS	
Rev. No		Page 42 of 47

		10.3.4 HEAT TREATMENT	:
		10.3.5 BALANCING FACILITY	:
		10.3.6 SURFACE TREATMENT PRIOR TO PAINTING/ COATING, POLISHING, PICKLING, PASSIVATION, PAINTING, ETC.	:
	10.4	SUPERVISORY STAFF	:
	10.5	ADEQUACY OF SKILLED LABOURS (MACHINISTS, WELDERS, ETC.)	:
	10.6	NO. OF SHIFTS	:
	10.7	TYPE OF MATERIAL HANDLED (SUCH AS CS, SS, ETC.)	:
	10.8	WORKMANSHIP	:
	10.9	MATERIAL IN STOCK AND VALUE	:
	10.10	TRANSPORT FACILITIES	:
	10.11	CARE IN HANDLING	:
11.0	INSPECTION / QC / QA / TESTING		
	11.1	NUMBER OF PERSONNEL (INDICATE NO.OF YEARS OF EXPERIENCE)	:
	11.2	INDEPENDENCE FROM PRODUCTION	:
	11.3	AVAILABILITY OF PROCEDURAL WRITE UP/QUALITY PLAN	:
	11.4	INCOMING MATERIAL CONTROL AND DOCUMENTATION	:
	11.5	RELIABILITY/REPUTATION OF SUPPLY SOURCES	:
	11.6	STAGE INSPECTION AND DOCUMENTATION	:
	11.7	SUB-ASSEMBLY & DOCUMENTATION	:
	11.8	FINAL INSPECTION AND DOCUMENTATION	:
	11.9	PREPARATION OF FINAL DOCUMENTATION PACKAGE	:
	11.10	TYPE TEST FACILITIES	:
	11.11	ACCEPTANCE TEST FACILITIES	:

Doc. Title	GENERAL CONDITIONS OF CONTRACT FOR SUPPLY ORDERS	
Rev. No		Page 43 of 47

	11.12	CALIBRATION OF INSTRUMENTS AND GAUGES (WITH TRACEABILITY TO NATIONAL STANDARDS) (ATTACH LIST)	:
	11.13	STATUTORY APPROVALS LIKE BIS, IBR, ETC.(AS APPLICABLE)	:
	11.14	SUB-VENDOR APPROVAL SYSTEM AND QUALITY CONTROL	:
	11.15	DETAILS OF TESTS CARRIED OUT AT INDEPENDENT RECOGNISED LABORATORIES	:
		i) FURNISH LIST OF TESTS CARRIED OUT AND THE NAME OF THE LABORATORY WHERE THE TESTS WERE CONDUCTED	:
		ii) CHECK AVAILABILITY OF CERTIFICATES AND REVIEW THESE WHEREVER POSSIBLE	:
12.0		EXPERIENCE (INCLUDING CONSTRUCTION / ERECTION / COMMISSIONING) TO BE FURNISHED IN THE FORMAT INDICATED IN APPENDIX)	:
13.0		SALES, SERVICE AND SITE ORGANISATIONAL DETAILS	:
14.0		CERTIFICATE FROM CUSTOMERS (ATTACH COPIES OF DOCUMENTS)	:
15.0		POWER SITUATION	:
16.0		LABOUR SITUATION	:
17.0		APPLICABILITY OF SC/ST RELAXATION (Y/N) IF YES, SUPPORTING DOCUMENTS TO BE ATTACHED	
Part C Supporting Documents			

Doc. Title	GENERAL CONDITIONS OF CONTRACT FOR SUPPLY ORDERS	
Rev. No		Page 44 of 47

18.0	<p>DOCUMENTS TO BE ENCLOSED:</p> <ol style="list-style-type: none"> 1. Factory License 2. ISO Certificate 3. Registration of Central Excise 4. Income Tax Clearance. 5. PF Registration 6. ESI Registration 7. Insurance for Workman Compensation Act No. 8. Electrical Contract LIC No. 9. PAN No. 10. GST Registration 11. MSME Certification 12. WC Tax Registration 13. Organogram of Co. having organogram of Design, safety, quality, production and other teams. 14. Details of subscription of BIS, IEC, IEE, ASTM or other. 15. Details of the team in Design, Quality, Safety, Production. 16. List of manufacturing equipment as per Part C. 17. List of calibrated equipment as per Part C. 18. List of clients and order executed in past two years. 19. Complaint escalation matrix. 20. Performance Certificates of same product from Minimum two utilities. 21. e-Payment Form as per enclosed Annexure-G 	
-------------	---	--

*** Classification of BAs under SC/ST shall be governed under following guidelines:**

- **Proprietorship/ Single Ownership Firm:** Proprietor of the firm should be from SC/ST community. Governing document shall be Proprietorship Deed.
- **Partnership Firm:** Only such firms shall qualify which have SC/ST partners holding equal to or more than 50% of the total ownership pattern of the firm. Governing document shall be Partnership Deed.
- **Private Limited Company:** Only such firms shall qualify which have SC/ST directors holding equal to or more than 50% of the total ownership pattern of the firm. Governing document shall be Memorandum of Understanding (MoU) and/or Article of Association (AoA).
- The relaxation available for BAs under SC / STs shall be as per GCC for Tender Fees, EMD, PBG and Turnover criteria.

NOTE: Certification from SC/ST Commission shall be required for deciding upon SC/ST status of a person.

Annexure-G (e-Payment detail form) must be filled by Associate along with this form.

Doc. Title	GENERAL CONDITIONS OF CONTRACT FOR SUPPLY ORDERS	
Rev. No		Page 45 of 47

ANNEXURE-I
MANUFACTURER AUTHORIZATION FORM

(To be submitted on OEM's Letter Head)

Date:

Tender Enquiry No.:

To,
Chief (Contracts & MM)
TPNODL,
Balasore

Sir,

WHEREAS M/s. *[name of OEM]*, who are official manufacturers of having factories at *[address of OEM]* do hereby authorize M/s *[name of bidder]* to submit a Bid in relation to the Invitation for Bids indicated above, the purpose of which is to provide the following Goods, manufactured by us

.....and to subsequently negotiate and sign the Contract.

We hereby extend our full guarantee and warranty in accordance with the Special Conditions of Contract or as mentioned elsewhere in the Tender Document, with respect to the Goods offered by the above firm in reply to this Invitation for Bids.

We hereby confirm that in case, the channel partner fails to provide the necessary services as per the Tender Document referred above, M/s *[name of OEM]* shall provide standard warranty on the materials supplied against the contract. The warranty period and inclusion / exclusion of parts in the warranty shall remain same as defined in the contract issued to their channel partner against this tender enquiry.

Yours Sincerely,

For

Authorized Signatory

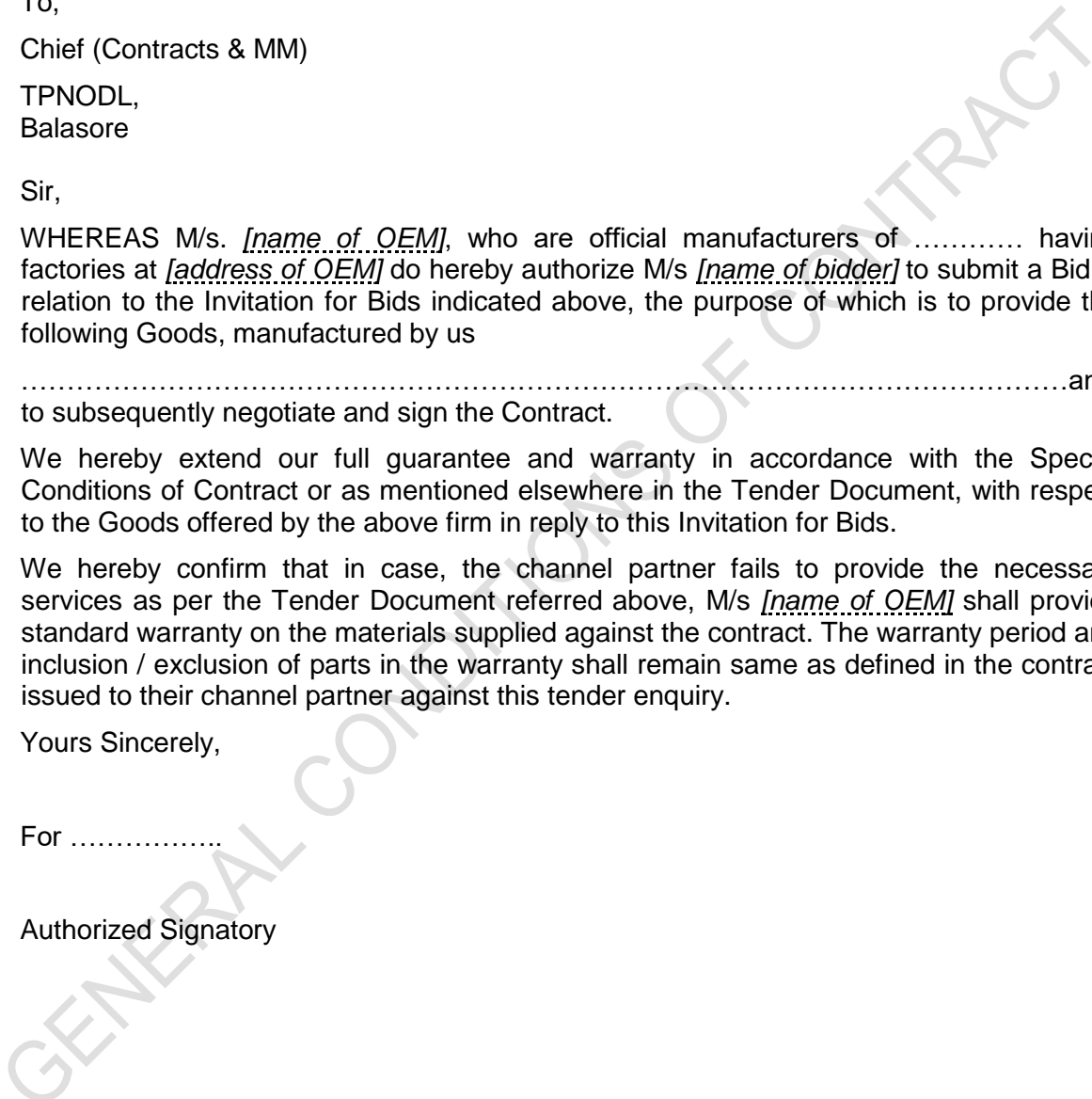

Doc. Title	GENERAL CONDITIONS OF CONTRACT FOR SUPPLY ORDERS	
Rev. No		Page 46 of 47

Annexure-J

TATA CODE OF CONDUCT (TCoC)

Introducing Tata Code of Conduct (TCoC) in GCC, the following clause is proposed for inclusion as per suggestions from Chief Ethics Counsellor -

“TCoC is the overarching policy framework that applies to all TATA Group companies including TPNODL. TCoC provides for stakeholder-wise approach in each of the seven chapters.

The chapter “Our Value Chain Partners” states the policy as follows:

1. We shall select our suppliers and service providers fairly and transparently.
2. We seek to work with suppliers and service providers who can demonstrate that they share similar values. We expect them to adopt ethical standards comparable to our own.
3. Our suppliers and service providers shall represent our company only with duly authorized written permission from our company. They are expected to abide by the Code in their interactions with, and on behalf of us, including respecting the confidentiality of information shared with them.
4. We shall ensure that any gifts or hospitality received from, or given to, our suppliers or service providers comply with our company’s gifts and hospitality policy.
5. We respect our obligations on the use of third party intellectual property and data.

In case any Ethical Concern is faced during the course of your business dealings BA can write to Chief- Contracts & MM and CEO.

TPNODL is committed to follow Core Values and Core Principles mentioned in TCoC, cited below, in carrying out various activities as well as in discharge of bi-lateral and multi-lateral obligations involving other entities/organizations:

Core Values:

All six core values are already mentioned in GCC.

Core Principles:

1. **Zero tolerance to bribery or corruption** in any form.
2. Committed to **good corporate citizenship**
3. Contribute to the **economic development of the communities** of the countries & regions we operate in.
4. No compromise on **Safety**
5. Our conduct shall be **fair & transparent**
6. Respect the **human rights & dignity** of our stakeholders
7. **No unfair discrimination** of any kind
8. Statements made to stakeholders shall be **truthful & made in good faith**
9. Not engage in any restrictive or **unfair trade practice**
10. Provide avenues for our stakeholders to **raise concerns in good faith**
11. Environment **free from fear** of retribution to deal with concerns that are raised
12. Expect the leaders to be **role model**

Doc. Title	GENERAL CONDITIONS OF CONTRACT FOR SUPPLY ORDERS	
Rev. No		Page 47 of 47

13. Comply with the laws of the countries in which we operate

Gift Policy:

Principles for acceptance of gifts/benefits –

A gift or benefit may be accepted only if it complies with all of the following principles:

- ✓ it does not influence,
- ✓ does not have the potential to influence, an employee in such a way as to compromise or appear to compromise integrity and impartiality
- ✓ does not create a conflict of interest or perception of conflict of interest;

Principles for non-acceptance of gifts/benefits -

The gift or benefit may not be accepted or given if any of the following principles apply:

- ✓ causes the recipient or donor **to act in partial manner** in the course of duty
- ✓ apprehension of the recipient becoming **obligated to the donor**
- ✓ it is **not offered openly**
- ✓ if is an **offer of money** or something readily convertible to money (e.g. Shares)

Violation –

1. Not abiding with this policy would constitute violation of “Our Employees” Stakeholder group Clause “Gifts and Hospitality” of the Tata Code of Conduct (TCoC) 2015. Prompt action will be taken against violations.
 2. Any deviation from this policy must be supported by appropriate rationale and must be duly approved by CEO who is also the Principal Ethics Officer. In any case, in dealing with such deviations, the spirit of the TCoC should in no case be compromised.
2. If it is determined that an employee / associate has violated this policy, appropriate action including termination of the employee’s / associate’s employment or association with TPNODL may be decided upon.

TPSODL	TP SOUTHERN ODISHA DISTRIBUTION LIMITED		
	WORK INSTRUCTION /OPERATING GUIDELINES		
Doc. Title	GENERAL CONDITIONS OF CONTRACT FOR SUPPLY ORDERS		
Rev. No	3	Rev. Dt.	28.07.2022
			Page 1 of 48

CONTENTS	
CLAUSE NO.	DESCRIPTION
1.0	ORGANIZATIONAL VALUES
2.0	ETHICS
3.0	CONTRACT PARAMETERS
3.1	Issue/Award of Contract
3.2	Contract Commencement Date
3.3	Contract Completion Date
3.4	Contract Period/ Time
3.5	Contract Execution Completion Date
3.6	Contract Price /Value
3.7	Contract Document
3.8	Contract Language
3.9	Reverse Auction
4.0	SCOPE OF WORK
5.0	PRICES/RATES/TAXES
5.1	Changes in statutory Tax Structure
6.0	TERMS OF PAYMENT
6.1	Quantity Variation
6.2	Full and Final Payment
7.0	MODE OF PAYMENT
8.0	SECURITY CUM PERFORMANCE DEPOSIT
9.0	STATUTORY COMPLIANCE
9.1	Compliance to Various Acts
9.2	SA 8000
9.3	Affirmative Action
9.4	Preferential norms for procurement from MSMEs registered in the State of Odisha
10.0	QUALITY
10.1	Knowledge of Requirements
10.2	Material/Equipment/Works Quality

Doc. Title	GENERAL CONDITIONS OF CONTRACT FOR SUPPLY ORDERS	
Rev. No	3	Page 2 of 48

CONTENTS	
CLAUSE NO.	DESCRIPTION
10.3	Adherence to Rules & Regulations
10.4	Specifications and Standards
11.0	INSPECTION/PARTICIPATION
11.1	Right to Carry Out Inspection
11.2	Facilitating Inspection
11.3	Third Party Nomination
11.4	Waiver of Inspections
11.5	Incorrect Inspection Call
12.0	MDCC & DELIVERY OF MATERIALS
12.1	Material Dispatch Clearance Certificate
12.2	Right to Rejection on Receipt
12.3	Consignee
12.4	Submission of Mandatory Documents on Delivery
12.5	Dispatch and Delivery Instructions
13.0	GUARANTEE
13.1	Guarantee of Performance
13.2	Guarantee period
13.3	Failure in Guarantee period (GP)
13.4	Cost of repairs on failure in GP
13.5	Guarantee Period for Goods Outsourced
13.6	Latent Defect
13.7	Support beyond the Guarantee Period
14.0	LIQUIDATED DAMAGES
14.1	LD Waiver Request
15.0	UNLAWFUL ACTIVITIES
16.0	CONFIDENTIALITY
16.1	Documents
16.2	Geographical Data
16.3	Associate's Processes
16.4	Exclusions
16.5	Violation

Doc. Title	GENERAL CONDITIONS OF CONTRACT FOR SUPPLY ORDERS	
Rev. No	3	Page 3 of 48

CONTENTS	
CLAUSE NO.	DESCRIPTION
17.0	INTELLECTUAL PROPERTY RIGHTS
18.0	INDEMNITY
19.0	LIABILITY & LIMITATIONS
19.1	Liability
19.2	Limitation of Liability
20.0	FORCE MAJEURE
21.0	SUSPENSION OF CONTRACT
21.1	Suspension for Convenience
21.2	Suspension for Breach of Contract Conditions
21.3	Compensation in lieu of Suspension
22.0	TERMINATION OF CONTRACT
22.1	Termination for Default/Breach of Contract
22.2	Termination for Convenience of Associate
22.3	Termination for Convenience of TPSODL
23.0	DISPUTE RESOLUTION AND ARBITRATION
23.1	Governing Laws and jurisdiction
24.0	ATTRIBUTES OF GCC
24.1	Cancellation
24.2	Severability
24.3	Order of Priority
25.0	ERRORS AND OMISSIONS
26.0	TRANSFER OF TITLES
27.0	INSURANCE
28.0	SUGGESTIONS & FEEDBACK
29.0	CONTACT POINTS
30.0	LIST OF ANNEXURES

Doc. Title	GENERAL CONDITIONS OF CONTRACT FOR SUPPLY ORDERS	
Rev. No	3	Page 4 of 48

1.0 ORGANIZATIONAL VALUES

The Tata Group has always been a value driven organization. These values continue to direct the Group's growth and businesses. The six core Tata Values underpinning the way we do business are:

Integrity - We must conduct our business fairly, with honesty and transparency. Everything we do must stand the test of public scrutiny.

Understanding - We must be caring, respectful, compassionate and humanitarian towards our colleagues and customers around the world and always work for the benefit of India.

Excellence - We must constantly strive to achieve the highest possible standards in our day to day work and in the quality of goods and services we provide.

Unity - We must work cohesively with our colleagues across the group and with our customers and partners around the world to build strong relationships based on tolerance, understanding and mutual co-operation.

Responsibility - We must continue to be responsible and sensitive to the countries, communities and environments in which we work, always ensuring that what comes from the people goes back to the people many times over.

Agility - We must work in a speedy and responsive manner and be proactive and innovative in our approach.

2.0 ETHICS

In our effort towards Excellence and in Management of Business Ethics at TPSODL, an Ethics Management Team is constituted.

The main objective of the Ethics Management Team is to:

1. Record, address and allay the issues and concerns on ethics raised by different stakeholders like employees, consumers, vendors, Associates etc. by initiating immediate corrective actions.
2. Ensure proper communication of the ethics policies and guidelines through prominent displays at all offices of TPSODL and through printed declarations in all concerned documents where external stakeholders are involved.
3. Ensure proper framework of policies as preventive measures against any ethics violation recorded by them.

Doc. Title	GENERAL CONDITIONS OF CONTRACT FOR SUPPLY ORDERS	
Rev. No	3	Page 5 of 48

4. Prepare and submit MIS of all issues and concerns, corrective and preventive actions on monthly basis to the top management for their information.

All Associates and Stakeholders are requested to register any grievance on ethics violation on our website www.tpsouthernodisha.com

3.0 CONTRACT PARAMETERS

3.1 Issue/Award of Contract

TPSODL awards the contract to the Associate in writing in the form of Purchase Order (PO) or Rate Contract (RC), hereafter referred as Contract, through in any or all of following modes physical handover / post / e-mail / web document / fax with all the attachments/enclosures which shall be part of the contract document.

On receipt of the contract, the associate shall return to TPSODL copy of the contract document duly signed by legally authorized representative of associate, within two days of Effective Date of Contract for contracts having contract execution time less than 30 days and within five days for all other contracts.

3.2 Contract Commencement Date

The date of issue/award of contract shall be the Effective Date of Contract or Contract Commencement date.

3.3 Contract Completion Date

The date of expiry of Guarantee Period shall be deemed as the Contract Completion Date.

3.4 Contract Period/Time

The period from Contract Commencement Date to Contract Completion Date shall be deemed as the Contract Period/Time.

3.5 Contract Execution Completion Date

The stipulated date for completing the supply as per schedule of quantities shall be deemed as the Contract Execution Completion Date.

3.6 Contract Price /Value

The total all inclusive price/value mentioned in the PO/RC is the Contract Price/Value and is based on the quantity, unit rates and prices quoted and awarded and shall be subject to adjustment based on actual quantities supplied and accepted and certified by the authorized representative of the company unless otherwise specified in schedule of quantities or in contract documents.

3.7 Contract Document

The Contract Document shall mean and include but not limited to the following:

- NIT/Tender Enquiry, QR, Instruction to Bidders, Special Condition of Contract (SCC) of tender, GCC, Technical & Commercial Specifications including relevant annexure and attachments).

Doc. Title	GENERAL CONDITIONS OF CONTRACT FOR SUPPLY ORDERS	
Rev. No	3	Page 6 of 48

- Bids & Proposals Received from Associate including relevant annexure/attachments.
- RC/PO with agreed deviations from the tender/bid documents.
- All the Inspection and Test reports, Detailed Engineering Drawings.
- Material Dispatch Clearance Certificate (MDCC).
- Minutes of Meeting (MoM)

3.8 Contract Language

All documents, instructions, catalogues, brochures, pamphlets, design data, norms and calculations, drawings, operation, maintenance and safety manuals, reports, labels, on deliveries and any other data shall be in English Language.

The Contract documents and all correspondence between the TPSODL, Third Parties associated with the contract, and the Associate shall be in English language.

However, all signboards required indicating "Danger" and/or security at site and otherwise statutory required shall be in English, Hindi, and local languages.

3.9 Reverse Auction

TPSODL reserves the right to conduct the reverse auction (instead of public opening of price bids) for the products / services being asked for in the tender. The terms and conditions for such reverse auction events shall be as per the Acceptance Form attached in Annexure F.

Bid validity will stand get automatically extended from the date of latest Negotiation event i.e. Reverse Auction or Manual Negotiation and accordingly bid shall be valid further

- i. For minimum 45 days if original bid validity duration is lesser than 45 days at latest negotiation date.
- ii. For actual bid validity duration if original bid validity is more than 45 days at latest negotiation date.

4.0 SCOPE OF WORK

All the activities that are to be undertaken by the Associate to realize the contractual deliverables in completeness form Scope of Work. Following clauses list, but not limited to, major requirements of the scope of work.

The associate shall satisfy himself and undertake fully the technical/commercial requirements of items to be supplied as listed in the Schedule of Quantities together with the tests to be performed /test reports to be furnished before dispatch, arrangement of stage and final inspections during manufacturing as per terms and conditions of contract, technical parameters & delivery terms and conditions including transit insurance to be met in order to fully meet TPSODL's requirements.

Completeness: Any supplies and services which might have not been specifically mentioned in the Contract but are necessary for the scope mentioned in Special Terms & Conditions and/or completeness of the works at the highest possible level, including any royalties, license fees & compensation to be paid, whether incurred by the associates or by a third party for the work covered in the scope, regardless of when incurred, shall be supplied/provided by the associate

Doc. Title	GENERAL CONDITIONS OF CONTRACT FOR SUPPLY ORDERS	
Rev. No	3	Page 7 of 48

without any extra cost and within the time schedule for efficient , smooth and satisfactory operation and maintenance of the works at the highest possible level under Indian conditions (but according to international standards for facility of this type), unless expressly excluded from the scope of supplies and services in this Contract.

TPSODL have the right, during the performance of the Contract, to change the scope and/or technical character of the Project and/or of the supplies and services stipulated in the Contract by submitting a request in writing to the Associate. The Associate shall, within fifteen days of receipt of such request from the TPSODL, provide Purchaser with a reasonably detailed estimate of the cost of the change outlined in the request.

In the event, TPSODL requests a change, the Contract price and time shall be adjusted upwards or downwards, as the case may be and shall be mutually agreed to. The associate shall not be entitled to any extension of time unless such changes adversely affect the time schedule.

The Associate shall not proceed with the changes as requested till adjustment of contract price and time schedule where so applicable in terms of or otherwise directed by the TPSODL.

5.0 PRICES/RATES/TAXES

Unless specified elsewhere in the contract document, the prices/rates are inclusive of cost of finished product for which MDCC will be issued by TPSODL, packaging and forwarding charges, freight and transit insurance charges covering loading at Associate's works, transportation to TPSODL store/site & unloading & delivery at TPSODL stores/TPSODL site, cost of documentation including all the relevant test certificates and other supportive documents to be furnished.

The Prices/Rates are inclusive of all taxes, levies, cess and duties, particularly Goods and Services Tax as applicable. All government levy / taxes shall be paid only when the invoice is submitted according to the relevant act.

The prices/rates shall remain firm till actual completion of entire supply of goods/material/equipment as per contract is achieved and shall remain valid till the completion of the contract.

The prices shall remain unchanged irrespective of TPSODL making changes in quantum in all or any of the schedules of items of contract.

5.1 Changes in Statutory Tax Structure

If rate of any or all of the statutory taxes and duties applicable to the contract changes, such changes shall be incorporated by default if the changes occur within the contract execution time and shall be applicable if the contract is executed by the Associate within the Contract Execution Time.

For execution of contracts beyond contract execution time, where the delay is not attributable to TPSODL no upward revision in tax /duties shall be considered irrespective of changes in the statutory tax structure either within the contract execution time or beyond. However, in such cases, benefits due to any downward revisions in statutory tax rates shall be passed on to TPSODL.

Doc. Title	GENERAL CONDITIONS OF CONTRACT FOR SUPPLY ORDERS	
Rev. No	3	Page 8 of 48

6.0 TERMS OF PAYMENT

On delivery of the materials in good condition and certification of acceptance by TPSODL official, Associate shall submit the Bills/Invoices in original in the name of "The TP Southern Odisha Distribution Limited" to invoice desk, complete with all required documents as under:

- Test Reports (4 sets).
- MDCC issued by TPSODL.
- Packing List.
- Drawing and Catalogue.
- Guarantee/Warrantee Card.
- Delivery Challan.
- O&M Manual.
- Copy of Order.
- Minutes of Meeting.

Bills/ invoices shall mention Supplier's GST Number. TPSODL will make 100% payment within 30 days of submission of the Bill/Invoice complete in all respects and along with all the requisite documents mentioned above, subject to condition that Associate has furnished the requisite Security-cum-Performance Guarantee as stipulated in the contract.

6.1 Quantity Variation

Payment will be made on the basis of actual quantity of supplies/actual measurement of works accepted by TPSODL and not on the basis of contract quantity.

6.2 Full and Final Payment

Full & Final Payment in all contracts shall be made subject to the associate submitting "No Demand Certificate" in the format as per Annexure-C.

7.0 MODE OF PAYMENT

Payment shall be made through crossed Cheque or RTGS whichever of the two modes chosen by the Associate, in favour of Associate's Bank Account on TPSODL records, on whose name Contract has been issued. Those Associates opting for the RTGS mode shall submit the details of Bank Account and other details as per annexure G. Further, for any payments made, TPSODL is not responsible for any consequences/disputes Associate have among the owners channel partners, sub-Associates and all such dispute/concerns shall be settled solely by the Associate.

Doc. Title	GENERAL CONDITIONS OF CONTRACT FOR SUPPLY ORDERS	
Rev. No	3	Page 9 of 48

8.0 SECURITY CUM PERFORMANCE DEPOSIT

Associates shall submit within 15 days from the effective date of issue of PO/RC, Security Performance Bank Guarantee (SPBG) in the format as per Annexure B of this document from banks acceptable to TPSODL for:

- (a) 5% of the PO value if purchase order value is more than Rs 5 Crores.
- (b) 10% of the PO value if purchase order value is less than Rs 5 Crores.

This shall remain valid till the end of the Guarantee Period of contract, plus one month.

- (c) 5% of the RC value in case of Rate Contract. This shall remain valid till the Guarantee period plus one month.

- For PO/RC values less than Rs. 5 lacs, Associate may request for deduction of amount equivalent to SPBG value from their first invoice. Such amount shall be withheld by TPSODL while processing the invoice and shall be released after completion of Guarantee Period plus one month.
- For PO/RC values less than Rs. 3 lacs, the clause (8.0) for Security cum Performance Bank Guarantee (SPBG) shall not be applicable.
- In case of RC (Rate Contract) after the expiry of RC validity, Associate shall have to submit SPBG. However, the Associate has the option to re-submit the SPBG as per actual RO (Release Order) value issued against the RC, valid for Guarantee Period plus one month. The Guarantee Period shall be considered as per the last RO issued against the said RC. The original SPBG as submitted against the RC shall be released on submission of the new SPBG to TPSODL. Alternatively, Associate may extend the validity of original SPBG only till the requisite period, i.e. Guarantee Period plus one month.

9.0 STATUTORY COMPLIANCE

9.1 Compliance to Various Acts

Associate should ensure adherence to all applicable laws, rules and regulation applicable under this contract from time to time. In case of violation any risk, costs etc shall be in associates account and keep TPSODL indemnified always till completion of contracts.

Doc. Title	GENERAL CONDITIONS OF CONTRACT FOR SUPPLY ORDERS	
Rev. No	3	Page 10 of 48

9.2 SA 8000

TPSODL expects its Associates to follow guidelines of SA 8000:2014 on the following aspects

1. Child Labour
2. Forced or Compulsory Labour
3. Health & Safety
4. Freedom of Association & Right to Collective Bargaining
5. Discrimination
6. Disciplinary Practices
7. Working Hours
8. Remuneration
9. Management System

9.3 Affirmative Action

TPSODL appreciate and welcome the engagement/employment of persons from SC/ST community or any other deprived section of society by their business associates.

Relaxation in Contract Clauses under Affirmative Action for SC/ ST Business Associates**

TPSODL believes that inclusive growth is the key to sustainable development, and to promote the same Policy on Affirmative Action for Scheduled Caste & Scheduled Tribe Communities has been adopted across the company.

Under the same pre-text, and to promote entrepreneurship among SC/ST community TPSODL has taken initiative by proposing relaxations in contract clauses as per below:

S. No	Initiative	for SC/ ST BA's	Guideline Document
1	Tender Fees	100% waiver for SC/ST community	All Open Tenders
2	Earnest Money Deposit	50 % relaxation of estimated EMD value	All limited and Open Tenders
3	Performance Bank Guarantee	50% relaxation in PBG for order value above 50 lacs else 25% relaxation	All limited and Open tenders
4	Turnover	25% relaxation in company turnover under qualifying requirement criteria	All Open Tenders

**Classification of BAs under SC/ST shall be governed under following guidelines:

- Proprietorship/ Single Ownership Firm: Proprietor of the firm should be from SC/ST community. Governing document shall be duly audited balance Sheet for the last FY bearing the name of proprietor.

Doc. Title	GENERAL CONDITIONS OF CONTRACT FOR SUPPLY ORDERS	
Rev. No	3	Page 11 of 48

- Partnership Firm: Only such firms shall qualify which have SC/ST partners holding equal to or more than 50% of the total ownership pattern of the firm. Governing document shall be Partnership Deed and audited balance sheet/ ITR for last FY.
- Private limited company: Only such firms shall qualify which have SC/ST directors holding equal to or more than 50% of the total ownership pattern of the firm. Governing document shall be Memorandum of Understanding (MoU) and/or Article of Association (AoA).

Governing document shall be Memorandum of Understanding (MoU) and/or Article of Association (AoA).

Note: Certification from SC/ST commission shall be required for deciding upon SC/ST status of a person.

9.4 Preferential norms for procurement from MSMEs registered in the State of Odisha

- i. MSME Business Associate registered in the State of Odisha is requested to inform the TPSODL if they fall under provisions of the Micro, Small and Medium Enterprises (MSME) Category and provide necessary documents to TPSODL. The Associate also needs to mention the relevant details on their invoice / bill.
- ii. MSME Business Associate registered in the State of Odisha shall submit the self-undertaking of registration in MSME category at the time of bidding as well as on an annual basis to TPSODL, enabling them to avail the consequent benefits, failing which TPSODL may take appropriate action against such defaults.
- iii. **Tender Fees** - To participate in the tender, MSMEs registered in the State of Odisha shall pay Rs.1,000/- including GST towards cost of tender paper.
- iv. **Earnest Money Deposit (EMD)** - EMD shall be exempted for MSME registered in the State of Odisha. However, Bidder shall be barred to participate in the tendering process for a period of 2 years in case it backs out post award of the contract.

v. **Qualification Requirement for Open Tenders**

Qualification Requirement of Financial Turnover for MSME registered in the State of Odisha shall be reduced to 20% of the existing criteria.

For Technical Qualification, instead of relying on the volumes / value of earlier Supplies / Projects, assessment of the Bidder shall be done on the basis of feedback from Customers. Past performance experience at Tata Power and its Group Companies shall supersede feedback from other Customers.

- vi. **Performance Bank Guarantees**- Performance Bank Guarantee for MSME registered in the State of Odisha shall be 25% of the value normally prescribed.

Doc. Title	GENERAL CONDITIONS OF CONTRACT FOR SUPPLY ORDERS	
Rev. No	3	Page 12 of 48

10.0 QUALITY

10.1 Knowledge of Requirements

The Associate shall be deemed to have carefully examined and to have knowledge of the equipment, the general and other conditions, specifications, schedules, drawings, etc. forming part of the Contract and also to have satisfied himself as to the nature and character of the work to be executed and the type of the equipment and duties required including wherever necessary of the site conditions and relevant matters and details. Any information thus procured or otherwise obtained from TPSODL/Consultants shall not in any way relieve the Associate from his responsibility and executing the works in accordance with the terms of contract.

10.2 Material/Equipment/Works Quality

The items / works under the scope of the Associate shall be of the best quality and workmanship according to the latest engineering practice and shall be manufactured from materials of best quality considering strength and durability for their best performance and, in any case, in accordance with the specifications set forth in this Contract. All material shall be new. Substitution of specified material or variation from the process of fabrication/ construction/ manufacture may be permitted but only with the prior written approval of the TPSODL.

10.3 Adherence to Rules & Regulations

The Associate shall procure and/or fabricate/erect all materials and equipment in accordance with all requirements of Central and State enactment, rules and regulations governing such work in India and at site. This shall not be construed as relieving the Associate from complying with any requirement of TPSODL as enumerated in the Contract which may be more rigid than and not contrary to the above mentioned rules, nor providing such construction as may be required by the above mentioned rules and regulations. In case of variance of the Technical Specification from the laws, ordinance, rules and regulations governing the work, the Associate shall immediately notify the same to the TPSODL. It is the sole responsibility of the Associate, however, to determine that such variance exists. Wherever required by rules and regulations, the Associate shall also obtain the statutory authorities' approval for the plant, machinery and equipment to be supplied by the Associate.

10.4 Specifications and Standards

The Associate shall follow all codes and standards referred in the Contract Document. Codes and standards of other may be followed by the Associate with the prior written approval of TPSODL, provided materials, supplies and equipment according to the standard are equal to or better than the corresponding standards specified in the Contract.

Brand names mentioned in the Contract documents are for the purpose of establishing the type and quality of products to be used. The Associate shall not change the brand name and qualities of the bought out items without the prior written approval of the TPSODL. All such products and equipment shall be used or installed in strict accordance with original manufacturer's recommendations, unless

Doc. Title	GENERAL CONDITIONS OF CONTRACT FOR SUPPLY ORDERS	
Rev. No	3	Page 13 of 48

otherwise directed by the TPSODL. In any circumstances the codes, specimen and standards prescribed by any government agency should not be violated.

11.0 INSPECTION/PARTICIPATION

11.1 Right to Carry Out Inspection

TPSODL reserves the right to send its representatives for inspection or participation at various stages of contract execution listed below, applicable as per contract construction.

- During basic design and detail engineering of material/ Equipment carried out by Associate /Outsourced Agencies.
- During manufacturing stages of the product at Associate's/Associate's Outsourced Agency's Plant/Facility.
- During Pre-dispatch Inspection and Testing of finished/manufactured product at Associate's/Associate's outsourced Agency's Plant/Facility.
- During Installation & Commissioning Activities/Stages.
- Prior to Clearing of the completed installation for commissioning.
- Any other stage as find appropriate by TPSODL during contract execution time.

All inspections and participations shall be carried out by TPSODL giving written intimation to the Associate or receiving appropriate advance written inspection call from the Associate, unless otherwise specified elsewhere in the contract document.

11.2 Facilitating Inspection

The Associate shall provide all opportunities and information to TPSODL's engineers to get acquainted with the technical know-how and the methods and practices adopted by the Associate in basic and detail engineering. The Associate shall provide documents, drawings, calculations etc. as may be required by TPSODL's Engineers.

The Associate shall provide free of charge office accommodation, office facilities, secretarial services, communication facilities, general and drawing office stationary, etc. as may be reasonably required by the TPSODL's engineers. Similarly, facilities shall also be provided by Associate's outsource agencies/ partners/ authorized dealers (collectively termed as sub associates) if such basic and detail engineering activities are carried out in the design offices of sub-Associates.

The Associate shall be responsible for the safety of employees of TPSODL/Third Party Agency when they are at the Associate's /Associate's outsource agency's plant or facility for carrying out/witnessing inspection/testing. All statutory safety precautions as applicable shall be followed by the Associate during Inspection Testing. If TPSODL inspectors are not satisfied with the safety arrangements at the plant, TPSODL have the right to call off inspection till such time corrective action is taken by the Associate.

Before raising the call for pre-dispatch final inspection and testing, the Associate shall conduct all the tests—type tests, routine tests etc-as specified in the contract document and submit copies of the test certificates to TPSODL along with the inspection call, for scrutiny of TPSODL.

Doc. Title	GENERAL CONDITIONS OF CONTRACT FOR SUPPLY ORDERS	
Rev. No	3	Page 14 of 48

The Associate and TPSODL shall jointly document all the observations, comments and action points after completion of inspection and it shall be binding on the Associate to provide compliance on all the points requiring compliance and furnish the compliance report to the designated authority of TPSODL for receiving clearance for dispatch of materials

11.3 Third Party Nomination

TPSODL also may nominate a third party for the purpose of carrying out the inspection and such an agency shall be entitled to all the rights and privileges of TPSODL as far as conducting the inspection.

11.4 Waiver of Inspections

TPSODL on its own discretion shall chose to waive off any inspection and ask the Associate to submit all the test reports as applicable as per contract specifications, related to inspection and testing of the goods ordered for scrutiny and clearance for dispatch.

11.5 Incorrect Inspection Call

In case it is observed that the material offered for inspection is not ready at the time of TPSODL inspection visit rendering it as futile, all costs towards such inspection shall be recovered from the BA. Taxes as applicable on such recoveries shall be borne by the BA.

12.0 MDCC & DELIVERY OF MATERIALS

12.1 Material Dispatch Clearance Certificate

Associate shall deliver material/goods/equipment against Supply Contracts or Supply Part of Composite/Service Contracts only after receiving Material Dispatch Clearance Certificate (hereafter termed as MDCC) issued by designated authority of TPSODL. Material delivered at TPSODL stores or at project site without a valid MDCC issued by the designated official of TPSODL shall be rejected. MDCC shall be issued to associate furnishing compliance report on the action points documented during pre-dispatch inspection and testing at Associate's/ Sub Associate's plant/ facility. In case Pre-dispatch inspection is waived at the discretion of TPSODL, then, MDCC shall be issued on receiving all the test reports-routine& type-from the Associate and finding them in order.

The associate shall include and provide for securely protecting and packing the materials so as to avoid loss or damage during handling and transport by air, sea, rail and road or any other means.

All such packing shall allow to the extent possible for easy removal and checking at Site. The associate shall take special precautions to prevent rusting of steel and iron parts during transit by sea. Gas seals or other materials shall be utilized by the associate for protection against moisture during transit of all Plant and Equipment.

Each Equipment or parts of Equipment shall be tagged with reference to the assembly drawings and corresponding part numbers. Each bale or package shall contain a packing note quoting specifically the name of the associate, item description, quantity, item / package identification.

Doc. Title	GENERAL CONDITIONS OF CONTRACT FOR SUPPLY ORDERS	
Rev. No	3	Page 15 of 48

All packing cases, containers, packing and other similar materials shall be new and supplied free by the associate and it shall not be required to be returned to the associate.

Notwithstanding anything stated in this clause, the associate shall be entirely responsible for loss, damage or depreciation or deterioration to the materials and supplies due to faulty and/or insecure packing or otherwise during transportation to the Site until otherwise provided herein.

In case of the consignments dispatched by road, the associate shall ensure that it or its subcontractors:

- i) Identify and obtain the correct type of trucks/trailers, keeping in view the nature of consignments to be dispatched.
- ii) Take such actions as may be necessary to avoid all possible chances of damages during transit and to ensure that all packages are firmly secured.

Timelines for inspection and MDCC is as below:

S. No.	Inspection	MDCC issuance time including Inspection time (max.)
1	Outside Berhampur	12 days
2	Within Berhampur	5 days
3	Waiver*	3 working days

* Associate is expected to raise the inspection call assuming that Inspection shall be carried out by TPSODL. The decision for waiver of inspection shall be on sole discretion of TPSODL.

12.2 Right to Rejection on Receipt

Goods/Material/Equipment delivered in condition physically damaged & incomplete as a product ordered, or not packed and transported as per the terms and conditions of the contract is liable to be rejected. Such item shall be lifted back by Associates within 15 days from receipt of rejection note from TPSODL and have to supply back the material within next 30 days or within the timeframe mutually decided by Associate and TPSODL.

If delivery of the material is beyond the agreed time, Liquidated damage clause, mentioned in this GCC separately shall be applicable; but the period for levy of LD shall be considered as per the original delivery schedule and not from the agreed timelines for material rectification.

12.3 Consignee

Unless otherwise specified in the Contract Document/ Purchase Order/ Release Order, Materials/ Goods/ Equipment shall be consigned to "Stores-In-Charge", TPSODL, Berhampur

12.4 Submission of mandatory documents on Delivery

Following documents shall be mandatorily submitted by BA along with supply of material to TPSODL stores/site:

Doc. Title	GENERAL CONDITIONS OF CONTRACT FOR SUPPLY ORDERS	
Rev. No	3	Page 16 of 48

S. No.	Documents	Requisite
1	Invoice copy in original	With all consignments
2	LR copy	Wherever required
3	Packing list	With all consignments
4	MDCC	With all consignments
5	Purchase order / Release order	Signed copy
6	Test certificates	With all consignments
7	Inspection/JVR report	In case pre-dispatch inspection is conducted
8	Device data in CD as per template for metering items	Wherever applicable

12.5 Dispatch and Delivery Instructions

S. No.	Instructions
1	Purchase order/ Release order no. shall be mentioned on invoice and on material
2	TPSODL material code and material description shall be mentioned in invoice and on material.
3	"Property of TPSODL" shall be embossed on material.
4	The material shall be properly sealed and packed in standard packing as per purchase order terms & conditions.
5	The weight and quantity of material shall be mentioned wherever applicable
6	The material supplied shall be co-related with the packing list.
7	The name plate detail on equipment shall include Material code, Material description, specification detail of material [as applicable], Serial No. Year of manufacturing, PO/ RO no. and date, "PROPERTY OF TPSODL, Berhampur", Guarantee period and Associate's name.
8	In case of manual unloading, supplier / transporter shall deploy sufficient Labour for unloading the material at TPSODL central store. For heavy item(s), crane will be provided by TPSODL [unloading cost will be recovered from the associate].
9	The driver should have valid License and one helper in truck. All the documents of truck like registration papers, PUC etc. should be available in Truck.
10	BA representative should accompany the material and get it unloaded / stacked in his presence wherever possible.

Doc. Title	GENERAL CONDITIONS OF CONTRACT FOR SUPPLY ORDERS	
Rev. No	3	Page 17 of 48

13.0 GUARANTEE

13.1 Guarantee of Performance

Associates shall stand guarantee that the equipment and material supplied under the contract is free from design, manufacturing, material, construction, erection & installation and workmanship & quality defects and is capable of its due, rated and intended quality performance, as an integrated product delivered under the contract, for a specific period termed as Guarantee Period(as elaborated elsewhere in this clause). The Associate should also guarantee that the equipment/material is new and unused except for the usage required for the tests and checks required as part of quality assurance.

13.2 Guarantee Period

The Guarantee Period will be equipment/service/work specific and shall be as specified in the Standard Specifications of TPSODL for the equipment/material/service/work and where standard specifications are not part of contract documents or guarantee period is not specified in the standard specifications,, the guarantee period shall be as per the Special Terms and Conditions of the Contract. In case of no mention of the guarantee period in standard specifications or SCC Guarantee Period will be 12 Months from the Date of Commissioning or 24 months from the date of delivery of final lot of supplies made, whichever is earlier.

13.3 Failure in Guarantee Period (GP)

If the equipment and material supplied under the contract fails to perform its due, rated & intended quality performance, during the Guarantee period, the associate is liable to undertake repair/rectify/replace the equipment and material supplied within time frame specified in the SCC or elsewhere in the contract documents at associate's cost to make the equipment and material supplied/service or work rendered under the contract of performing its due, rated and intended quality performance. If Associate fails to repair/rectify/replace the equipment or material supplied rendered under the contract, failed in Guarantee Period, TPSODL will be at liberty to get the same done at Associate's risks and costs and recover all such expenses plus the TPSODL's own charges (@ 20% of expenses incurred), from the Associate or from the "Security cum Performance Deposit" as the case may be.

If during the Warranty/ Guarantee period some parts of the supplies are replaced owing to the defects/ damages under the Warranty, the Warranty period for such replaced parts shall be until the expiry of twelve months from the date of such replacement or renewal or until the end of original Guarantee period, whichever is later.

Any repairs during the Guarantee Period shall be carried out by the Associate within 30 days of reporting the issue to Associate by TPSODL. However, if replacement of the Equipment is required, Associate shall notify the same to TPSODL within 7 days of reporting the issue by TPSODL. Thereafter, the total time for supply of new equipment/ material shall be equal to the original delivery period of that equipment/ material as specified in the Contract. In case the Associate is not able to

Doc. Title	GENERAL CONDITIONS OF CONTRACT FOR SUPPLY ORDERS	
Rev. No	3	Page 18 of 48

rectify/ replace the faulty equipment/ material within the stipulated timelines as mentioned above, penalty shall be levied as per the Liquidated Damages clause mentioned in this document. The penalty amount shall be recovered from the payment due to the vendor or by encashment of the SPBG as the case may be.

13.4 Cost of repairs on failure in GP

The cost of repairs/rectification/replacement, required transportation, site inspection /mobilization/dismantling and re-installation costs as applicable, to be borne by Associate. The Associate has to ensure that the interruption in the usage of intended purpose of the equipment is minimized to the maximum extent In lieu of the time taken for repairs/rectification/replacement.

13.5 Guarantee period for Goods Outsourced

If the Associate outsources partly equipment/materials/services from third party as mutually agreed upon at the pre award stage of contract, TPSODL shall have the benefit of any additional guarantee period if provided by the third party for the part supplied/executed by them.

13.6 Latent Defect

Hidden defects in manufacturing or design of the product supplied and which could not be identified by the tests conducted but later manifested during operation of the equipment are termed as latent defects. Associates shall further be responsible for 'free replacement' for another period of THREE years from the end of the guarantee period for any 'Latent Defects' if noticed and reported by the Company.

13.7 Support beyond the Guarantee Period

The Associate shall ensure availability of spares and necessary support for a period of atleast 10 years post completion of guarantee period of equipment supplied against the contract.

14.0 LIQUIDATED DAMAGES

- a) For supplies which are of standalone use, multiple in quantities and having a single final delivery schedule, Liquidated damages shall be levied without prejudice to any of the other contractual rights of TPSODL, as described below:

For delay of each week and part thereof from the delivery schedule specified in the contract, 1% of contract value corresponding to undelivered quantity, provided full quantity is supplied within 130% of the original contract time. If full contractual quantity is not delivered within 130% of contract time for delivery, TPSODL has the right to levy LD on the entire contract value, subject to a maximum of 10% of the total contract value.

- b) For Supplies having phased delivery schedule as per contract terms, standalone use and multiple in quantities, Liquidated damages shall be levied without prejudice to any of the other contractual rights of TPSODL, as described below:

For the purpose of calculating and applying LD, each delivery lot shall be considered separately. For delay of each week and part thereof, from the delivery schedule specified for the lot, 1% of the

Doc. Title	GENERAL CONDITIONS OF CONTRACT FOR SUPPLY ORDERS	
Rev. No	3	Page 19 of 48

contract value corresponding to the undelivered quantity of the lot subject to a maximum of 10% of the total contract value of the subject lot. However, if full contractual quantity is not delivered within 130% of contract time for delivery, TPSODL has the right to levy LD on the entire contract value, subject to a maximum of 10% of the total contract value. Deduction of LD shall be on landed cost i.e contract value inclusive of taxes and in pursuant statutory compliance GST would be applicable at the stipulated rate and the same shall be borne by Business Associate. In case of LD deduction, a GST invoice shall be issued by TPSODL as a proof of deduction/ recovery.

GENERAL CONDITIONS OF CONTRACT

Doc. Title	GENERAL CONDITIONS OF CONTRACT FOR SUPPLY ORDERS	
Rev. No	3	Page 20 of 48

14.1 LD Waiver Request

Any request of LD waiver shall be submitted within thirty (30) days of deducting LD. Request submitted beyond the timeline shall not be entertained.

15.0 UNLAWFUL ACTIVITIES

The Associate shall have to ensure that none of its employees are engaged in any unlawful activities (whether covered under the scope of the present GCC or not) subversive of the TPSODL's interest failing which appropriate action (legal or otherwise) may be taken against the Associate by the TPSODL, in accordance with the terms of the present GCC.

16.0 CONFIDENTIALITY

Associate and its employees or representatives thereof shall strictly maintain the confidentiality of various information they come across while executing the contract as detailed below.

16.1 Documents

All maps, plans, drawings, specifications, schemes and other documents or information related to the Contract/Project and the subject matter contained therein and all other information given to the Associate by the TPSODL in connection with the performance of the contract shall be held confidential by the Associate and shall remain the property of the TPSODL and shall not be used or disclosed to third parties by the Associate for any purpose other than for which they have been supplied or prepared. The Associate may disclose to third parties, upon execution of confidentiality agreements, such part of the drawings, specifications or information if such disclosure is necessary for the performance of the Work provided such third parties agree in writing to keep such information confidential to the same extent and degree as provided herein, for the benefit of the TPSODL.

16.2 Geographical Data

Maps, layouts and photographs of the unit/plant including its surrounding regions showing vital installation for national security of country or those of TPSODL shall not be published or disclosed to the third parties or taken out of the country without prior written approval of the TPSODL and upon execution of confidentiality agreements satisfactory to the TPSODL with such third parties prior to disclosure.

16.3 Associate's Processes

Title to secret processes if any developed by the Associate on an exclusive basis and employed in the design of the equipment shall remain with the Associate. TPSODL shall hold in confidence such processes and shall not disclose such processes to the third parties without prior approval of the Associate and execution by such third parties of secrecy agreements satisfactory to the Associate prior to disclosure. Upon completion of contract, such processes shall become the property of the TPSODL. Title to technical specifications, drawings, flow sheets, norms, calculations, diagrams, interpretations of test results, schematics, layouts and such other information, which the Associate has supplied to the TPSODL under the Contract shall be passed on to the TPSODL. The TPSODL

Doc. Title	GENERAL CONDITIONS OF CONTRACT FOR SUPPLY ORDERS	
Rev. No	3	Page 21 of 48

shall have the right to use these for construction, erection, start-up, Trial Run, operation, maintenance, modifications and/or expansion of the works including for the manufacture of spare parts.

16.4 Exclusions

The provision of Clauses 16.1 to 16.3 shall not apply to information:

- Which at the time of disclosure are in the public domain which later on become part of public domain through no fault of the party concerned, or
- Which were in the possession of the party concerned prior to disclosure to him by the other party, or
- Which were received by the party concerned after the time of disclosure without restriction on disclosure or use, from a third party who did not acquire such information directly or indirectly from the other party or has no obligation of confidentiality for such information.

16.5 Violation

In case of violation of this clause, the Associate is liable to pay compensation and damages as may be determined by the competent authority of TPSODL.

17.0 INTELLECTUAL PROPERTY RIGHTS

If, in the course of performance of its functions and duties as envisaged by the scope of the present GCC, the Associate acquires or develops, any unique knowledge or information which would be covered, or, is likely to be covered within the definition of a trademark, copyright, patent, business secret, geographical indication or any other form of intellectual property right, it shall be obliged, under the terms of this present GCC, to share such knowledge or information with the TPSODL. All rights, with respect to, or arising from such intellectual property, as afore mentioned, shall solely vest in TPSODL.

Moreover, the Associate undertakes not to breach any intellectual property right vesting in a third party/parties, whether by breach of statutory provision, passing off, or otherwise. In the event of any such breach, the Associate shall be wholly liable to compensate, indemnify or make good any loss suffered by such third party/parties, or any compensation/damages arising from any legal proceeding/s, or otherwise. No liability of TPSODL shall arise in this respect, and any costs, damages, expenses, compensation payable by TPSODL in this regard to a third party/parties, arising from a legal proceeding/s or otherwise, shall be recoverable from the Associate.

18.0 INDEMNITY

The Associate shall at all times indemnify, keep indemnified and hold harmless the TPSODL and its officers, directors, employees, affiliates, agents, successors and assigns against all actions, claims, demands, costs, charges and expenses arising from or incurred by reason of any infringement of patent, trade mark, registered design, copy rights and/or industrial property rights by manufacture, sale or use of the equipment supplied by the Associate whether or not the TPSODL is held liable for

Doc. Title	GENERAL CONDITIONS OF CONTRACT FOR SUPPLY ORDERS	
Rev. No	3	Page 22 of 48

by any court judgement. In this connection, the TPSODL shall pass on all claims made against him to the Associate for settlement.

The Associate assumes responsibility for and shall indemnify and save harmless the TPSODL from all liability, claims, costs, expenses, taxes and assessments including penalties, punitive damages, attorney's fees and court costs which are or may be required to be paid by the TPSODL and its officers, directors, employees, affiliates, agents, successors and assigns arising from any breach of the Associate's obligations under the Contract or for which the Associate has assumed responsibilities under the Contract including those imposed under any local or national law or laws, or in respect to all salaries, wages or other compensation for all persons employed by the Associate or his Sub-Associates or suppliers in connection with the performance of any work covered by the Contract. The Associate shall execute, deliver and shall cause his Sub-Associate and suppliers to execute and deliver, such other further instruments and to comply with all the requirements of such laws and regulation as may be necessary there under to conform and effectuate the Contract and to protect the TPSODL.

The TPSODL shall not be held responsible for any accident or damages incurred or claims arising, due to the Associate's error there from prior to completion of work. The Associate shall be liable for such accidents and after completion of work for such accidents as the case may be due to negligence on his part to carry out Work in accordance with Indian laws and regulations and the specifications set forth herein.

19.0 LIABILITY & LIMITATIONS

19.1 Liability

Except for any specific liability which may be identified in the Contract and which may be payable hereunder, Associate shall not be liable for any special, incidental, indirect, or consequential Damages or any loss of business Contracts, revenues or other financial loss (or equivalents thereof no matter how claimed, computed or characterized) arising out of or in connection with the Performance of the Work or supply of Goods ***unless caused by Associate's negligence, willful misconduct or breach of contract.***

If the Associate is a joint venture or consortium, all concerned parties shall be jointly and severally bound to the TPSODL for the fulfillment of the provisions of the Contract. The consortium or the joint venture shall designate one party as their leader, who will be the coordinator between the parties and TPSODL. The constituents & leader of the consortium or joint venture shall not be changed without the prior consent of TPSODL.

TPSODL shall have no liability or any special, incidental, indirect or consequential Damages for any loss of Business Contracts, revenues or other financial loss arising out of this Contract.

19.2 Limitation of Liability

The total liability of Associate against any contract shall be limited to the Total All Inclusive Contract Value.

Doc. Title	GENERAL CONDITIONS OF CONTRACT FOR SUPPLY ORDERS	
Rev. No	3	Page 23 of 48

20.0 FORCE MAJEURE

Force Majeure applies if the performance by either Party ("the Affected Party") of its obligations under Contract is materially and adversely affected.

"Force Majeure" shall mean any event or circumstance or combination of events or circumstances referred below and their consequences that wholly or partly prevents or unavoidably delays any Party in the performance of its obligations under this Agreement, but only and to the extent that such events and circumstances are not within the reasonable control, directly or indirectly, of the Affected Party and could not have been avoided even if the Affected Party had taken reasonable care:

- Act of war (whether declared or undeclared), invasion, armed conflict or act of foreign enemy, embargo, blockade, revolution, riot, bombs, religious strife or civil commotion, etc.
- Politically motivated sabotage, or terrorism, etc.
- Action or Act of Government or Governmental agency for which remedy is beyond the control of the affected parties.
- Any act of God.

Note: Causes like power breakdown/ shortages/fire/strikes, accidents etc do not fall under Force Majeure.

Time being the essence of the Contract, if either party is prevented from the performance of its obligations in whole or in part due to an event of Force Majeure, then provided Notice of happening of any event by the Affected Party is given to the other party within seven (7) days from the date of occurrence of such event, which DIRECTLY has impact on works and submitted details and quantum of resulting effect, but at the same time had made all possible efforts to mitigate and overcome effects thereof, the Affected Party's performance under this Contract shall be suspended until such event ceases and the Scheduled Completion shall be delayed accordingly.

If Force Majeure event(s) continue for a period of more than three months, the parties shall hold consultation to discuss the further course of action.

Neither party shall be considered to be in default or in breach of its obligation under the Contract to the extent that performance of such obligation by either party is prevented by any circumstances of Force Majeure which arise after effective date of Contract.

Neither party can claim any compensation from the other party on account of Force Majeure.

21.0 SUSPENSION OF CONTRACT

21.1 Suspension for Convenience

TPSODL may, at any time and at its sole option, suspend execution of all or any portions of the schedule of items of contract to be supplied/work to executed by Associate under the contract by providing to the Associate at least two business days written notice for contracts having contract

Doc. Title	GENERAL CONDITIONS OF CONTRACT FOR SUPPLY ORDERS	
Rev. No	3	Page 24 of 48

completion period less than sixty days and at least seven business days' notice for all other contracts.

Upon receipt of any such notice, the Associate shall respond as follows as applicable as per contract construction.

- Immediately discontinue further supply of material/goods specified in the suspension notice for supply contracts
- Immediately discontinue further service/work and supply of materials of those services/materials/work specified in the suspension notice for service /composite contract
- Promptly make every reasonable effort to obtain suspension, upon terms satisfactory to TPSODL, of all orders, outsourcing arrangements, and rental Contracts to the extent that they relate to performance of the portion of Work suspended by the notice.
- Protect and maintain the portion of the service/Work already completed, including the portion of the Work suspended hereunder, unless otherwise specifically stated in the notice.
- Continue delivering/carrying out the supply/service/work items as per contract conditions, which do not fall under purview of the suspension notice.

On receipt of resumption notice from TPSODL, the Associate shall resume execution of contract as specified in the resumption notice, within the time frame specified in the resumption notice.

21.2 Suspension for Breach of Contract conditions.

TPSODL shall suspend execution of whole/or part thereof the contract till such time Associate complies with the conditions stipulated under section clause 22.1 for breach/default of contract conditions.

21.3 Compensation in lieu of Suspension

If the suspension of the contract in whole or in part is for convenience of TPSODL and not due to any breach of contract conditions by the associate, TPSODL at its discretion shall consider compensating all reasonable additional costs incurred by Associate in lieu of suspension of whole or part of contract, on representation of the Associate providing justified estimates of such additional costs and such estimates are found acceptable and approved by competent authority of TPSODL.

If the suspension of contract in whole or part thereof is due to breach of contract conditions (refer clause 22.1) by the Associate, Associate shall not be entitled for any compensation for any cost incurred in lieu of suspension of whole or part of contract and also shall be liable for compensating all the losses arising to TPSODL in lieu of suspension of contract. Resumption notice shall be subject to the Associate taking corrective action for the breach of contract conditions within the time frame and as per the terms specified in the suspension notice.

Doc. Title	GENERAL CONDITIONS OF CONTRACT FOR SUPPLY ORDERS	
Rev. No	3	Page 25 of 48

22 TERMINATION OF CONTRACT

22.1 Termination for Default/Breach of Contract

The contract / PO /RC shall be subject to termination by TPSODL in case of breach of the contract by the Associate which shall include but not be limited to the following:

- a. Withdrawal or intimation by the Associate of its intent to withdraw or surrender the execution / completion of the contracted work /PO or failure in ensuring adherence to any delivery schedules, in deviation of the contract/PO.
- b. Refusal or neglect on the part of the Associate to supply material/equipment of quantity or quality as specified by TPSODL and within the timeframe as specified in the contract document or refusal or neglect to execute the services/work in terms of the agreed standards of quantity or quality and/or within the timeframe specified in the contract/PO.
- c. Failure in any respect to perform any portion of the Work contracted with promptness, diligence, or in accordance with the terms of the contract.
- d. Failure to furnish guarantees as specified and /or failure to comply with the terms thereof.
- e. Failure to furnish such relevant documents or information within the time specified which may be necessary for due execution / completion of the works and documentation.
- f. Liquidation, bankruptcy either voluntary or involuntary OR entering into any composition or compromise with its creditors, or Insolvency.
- g. In case any reasonable information has been received by TPSODL that Associate has adopted/ or attempted to adopt any unethical conduct, action in award of the contract /PO or at any time thereafter.
- h. Failure to comply with applicable statutory provisions as contained in the contract or failure to comply with the applicable laws.
- i. Failure to comply with safety regulations/clauses stipulated in the contract or as may be generally instructed by TPSODL.

If the default or breach as specified under clause 22 (except sub clause g thereof) be committed by the associate for the first time, TPSODL shall issue, along the with notice of default or breach, a warning notice instructing the associate to take remedial/corrective action within the time frame stipulated in the warning notice and not to repeat the same in future. The timeframe for corrective action by the associate shall be specific to the nature of breach of contract and the same shall not be objected to by the Associate. If the Associate fails to comply with the instructions in the warning notice or in taking corrective action to the satisfaction of TPSODL then TPSODL may terminate the entire or part of contract at its discretion by issuing termination notice without incurring any liability on this ground.

Doc. Title	GENERAL CONDITIONS OF CONTRACT FOR SUPPLY ORDERS	
Rev. No	3	Page 26 of 48

In case the contract is terminated for any breach of the nature specified in clause 22 g stated above, TPSODL shall have the right to terminate all the contracts TPSODL is having with the Associate by issuing termination notice which shall be without prejudice to the other rights of TPSODL available to it under law.

Without prejudice to its right to terminate for breach of contract, TPSODL may, without assigning any reason, terminate the Contract in whole or in part at any time at its discretion while the contract is in force by serving a written notice of two weeks to the Associate.

In the event of TPSODL having proceeded with termination of the contract the associate shall comply and proceed further in the following manner:

- a) Associate shall discontinue the supply, on the expiry of the said period of two weeks.
- b) Associate shall ensure that no further steps are being taken towards discharge of the obligations, terms and conditions as contained in the contract/PO. This shall include initiation of actions not limited to discontinuation of other allied and associated arrangements which the associate might have entered into with third parties for due discharge of its obligations under the contract with TPSODL.
- c) The Associate shall perform thereafter such tasks as may be necessary to preserve and protect the terminated portion of the material/service/work in progress and the materials and equipment at TPSODL sites or in transit thereto. However the associate shall continue to fulfill its contractual obligations with regard to the part of contract not terminated.
- d) It shall be open for TPSODL to conduct a joint assessment with the associate of the material, supplies, equipment, works or in general as to the subject matter of the contract in regard to which the associate claims having completed its obligations before or during such termination.
- e) It shall be open to TPSODL to seek invocation of the performance bank guarantee or any other guarantee or other security deposit by whatever name called submitted by the associate, which shall not be objected to or protested against by the associate.

In case of termination of the contract the parties agree to be governed inter alia by the following:

- a) In case TPSODL exercises its right of termination as stated above the associate shall not dispute or object to the same.
- b) The Associate shall be entitled to receive and claim only such payments OR sums of money from TPSODL as may be found payable to it in regard to works executed by it under the terms of the contract and no other claim of any nature whatsoever shall be made by the Associate.
- c) All such provisions which the parties have agreed to survive and prevail even after termination of the contract shall remain effective despite the termination.

Doc. Title	GENERAL CONDITIONS OF CONTRACT FOR SUPPLY ORDERS	
Rev. No	3	Page 27 of 48

In the event of such termination, TPSODL may finish the Work by whatever method it may deem expedient, including the hiring of services and /or purchase of material equipment from such third parties as TPSODL may deem fit or may itself provide any labor or materials and perform any part of the Work. The associate undertakes to bear the incremental costs if any paid by TPSODL in such a case attributable to failure on the part of the associate. The Associate in such a case shall not be entitled to receive any further payments and any sums found payable to it may be adjusted by TPSODL against the amount recoverable from him on this ground. The same shall be without prejudice to other rights available to TPSODL under law against the associate.

Upon the termination of any of the contract due to occurrence of any circumstances provided in clauses stated above and constituting repeated breach or misconduct, TPSODL shall be entitled to bar the associates its agents, affiliates from undertaking any negotiation / tendering, bidding, participation activities concerning TPSODL for a period of two years from date of such termination. The same shall be without prejudice to other rights available to TPSODL.

22.2 Termination for Convenience of Associate

Associate at its convenience may request for termination of contract, clearly assigning the reason for such request. TPSODL has full right to accept, reject or partially accept such request. However, associate shall continue its supply as per contract till final approval is given to associates for such termination.

22.3 Termination for Convenience of TPSODL

TPSODL at its sole discretion may terminate the contract by giving 30 days prior notice in writing or through email to the Associate. TPSODL shall pay the Associate for all the supplies/ services rendered till the actual date of contract termination against submission of invoice by the Associate to that effect.

23.0 DISPUTE RESOLUTION & ARBITRATION

In case of any dispute or difference the parties shall endeavour to resolve the same through conciliatory and amicable measures within 15 Days failing which the matter may be referred by either party for resolution by the sole arbitrator to be appointed mutually by both the parties. The arbitral proceedings shall be conducted in accordance with Arbitration and Conciliation Act 1996 and the place of arbitration shall be Bhubaneswar. The language to be used at proceedings shall be English and the award of the arbitrator shall be final and binding on the parties. The parties shall bear their respective costs of arbitration. The associate shall continue to discharge its obligations towards due performance of the works as per the terms of the contract during the arbitration proceedings unless otherwise directed in writing by TPSODL or suspended by the arbitrator. Further, TPSODL shall continue making such payments as may be found due and payable to the associate for such works.

23.1 Governing Laws and Jurisdiction

The parties shall be subject to the jurisdiction of the courts of law in Berhampur and any matter arising here from shall be subject to applicable law in force in India.

Doc. Title	GENERAL CONDITIONS OF CONTRACT FOR SUPPLY ORDERS	
Rev. No	3	Page 28 of 48

24.0 ATTRIBUTES OF GCC

24.1 Cancellation

The Company reserves the right to cancel, add, delete at its sole discretion, all or any terms of this GCC or any contract, order or terms agreed between the parties in pursuance without assigning any reasons and without any compensation to the Associates.

24.2 Severability

If any portion of this GCC is held to be void, invalid, or otherwise unenforceable, in whole or part, the remaining portions of this GCC shall remain in effect.

24.3 Order of Priority

In case of any discrepancies between the stipulations in General Conditions of the Contract (GCC) and Special Conditions of Contract (SCC), the GCC shall stand superseded by the SCC to the extent stipulated hereinabove while balance portion of respective clauses of GCC shall continue to be applicable.

25.0 ERRORS AND OMISSIONS

The Associate shall be responsible for all discrepancies, errors and omissions in the drawings, documents or other information submitted by him, irrespective of whether these have been approved, reviewed or otherwise accepted by the TPSODL or not. However any error in design/drawing arising out of any incorrect data/written information from TPSODL will not be considered as error and omissions on part of the Associate.

26.0 TRANSFER OF TITLES

The title of ownership and property to all equipment, materials, drawings & documents shall pass to the TPSODL on acceptance of material by store/site after Inspection.

However, such passing of title of ownership and property to the TPSODL shall not in any way absolve, dilute or diminish the responsibility and obligations of the Associate under this Contract including loss or damages and all risks, which shall vest with the Associate.

27.0 INSURANCE

The Contractor (BA) shall take out the Insurance Policies which shall cover all risks including the following, as applicable:-

- a) The value of the policy shall cover the total value of all the items till they are handed over to TPSODL.
- b) TPSODL shall be the principal holder of the policy. The Associate shall be the loss payee under the policy. Associate / Sub-contractor of the Associate shall not be holders or beneficiaries in the policy nor shall they be named in the policy. TPSODL reserves the exclusive right to assign the policy.

Doc. Title	GENERAL CONDITIONS OF CONTRACT FOR SUPPLY ORDERS	
Rev. No	3	Page 29 of 48

- c) While the payment of premium may be phased in agreement with the insurance company, at no time shall goods and services required to be provided by the associate shall remain uninsured in accordance with (a) above.
- d) A copy of the Insurance policy shall be made available to TPSODL prior to first dispatch lot of any Equipment and policy shall be kept alive and valid at all times up to the stage of final acceptance.
- e) TPSODL reserves the right to take out whatever policy that is deemed necessary by him if the associate fails to keep the said policy alive and valid at all times and/or causes lapses in payment of premium thereby jeopardizing the said policy. The cost of such policy(s) shall be recovered / deducted from the amount payable to the associate.
- f) The policy shall ensure that the TPSODL's decision regarding replacement of goods damaged, lost or rendered unusable shall be final.

In all cases, the associate shall lodge the claims with the underwriters and also settle the claims and shall also notify TPSODL of any filed claims. However, the associate shall proceed with the repairs and/or replacement of the equipment/components without waiting for the settlement of the claims. In case of seizure of materials by concerned authorities, the associate shall arrange prompt release against bond, security or cash as required. TPSODL, upon request by the associate, will extend all reasonable assistance to the associate in such a case.

All the insurance claims shall be processed and settled by the associate and the missing/damaged items shall be replaced/repared by them without any extra cost to TPSODL and without affecting the completion time.

28.0 SUGGESTIONS & FEEDBACK

We welcome all our Business Associates to write to us about their experience with TPSODL; be it our Company, our services or our people. Each and every concern, issue, query and suggestion from you will help us to become a better company to work with and shall help us develop a strong bonding of trust and a long term relationship with you.

You may send your feedback by filling up our Business Associate Feedback Form enclosed herewith as *Annexure-E*. You can also log on to our website www.tpsouthernodisha.com to provide your feedback.

- Suggestions for us
- Feedback form
- Knowledge Sharing/ Experience with TPSODL
- Any issues with TPSODL.

Submission of feedback form is mandatory before the release of final payment to the BA.

Doc. Title	GENERAL CONDITIONS OF CONTRACT FOR SUPPLY ORDERS	
Rev. No	3	Page 30 of 48

29.0 CONTACT POINTS

In case Business Associate needs information with respect to payments or has any grievances, same may be lodged by log on to our website www.tpsouthernodisha.com

30.0 LIST OF ANNEXURES

S. No.	Subject	Annexure
1.	Performa for Bid Security Bank Guarantee	A
2.	Performa for Performance Bank Guarantee (CP cum EP)	B
3.	Performa for No Demand Certificate by Associate	C
4.	Performa For Application For Issuance of Consolidated TDS Certificate	D
5.	Business Associate Feedback Form	E
6.	Acceptance Form For Participation In Reverse Auction Event	F
7.	Form for RTGS Payment	G
8.	Vendor Appraisal Form	H
9.	Manufacturer Authorization Form	I

Doc. Title	GENERAL CONDITIONS OF CONTRACT FOR SUPPLY ORDERS	
Rev. No	3	Page 31 of 48

ANNEXURE-A

PROFORMA FOR BID SECURITY BANK GUARANTEE

**The TP Southern Odisha Distribution Limited
Berhampur**

WHEREAS, (Name of the Bidder) _____
(hereinafter called "the BIDDER") has submitted his bid dated _____ for the (Name of Contract) _____ (hereinafter called "the BID").

KNOW ALL men by these presents we (Name of the Bank) _____ of (Name of the Country) _____ having our registered office at _____ (hereinafter called "the BANK) are bound unto The TP Southern Odisha Distribution Limited (TPSODL) in the sum of _____ for which payment well and truly to be made to the TPSODL the Bank binds himself, his successors and assigns by these presents.

SEALED with the Common Seal of the said Bank this _____ day of _____ 20_____.

The CONDITIONS of this obligation are:

- i) If the Bidder withdraws his Bid during the period of bid validity specified in the Proforma of Bid or
- ii) If the Bidder having been notified of the acceptance of his Bid by the TPSODL during the period of bid validity fails or refuses to furnish the Contract Performance Bank Guarantee, in accordance with the Instructions to Bidders.

We undertake to pay the TPSODL upto the above amount upon receipt of its first written demand, provided that in its demand the TPSODL will note that amount claimed by it is due to it owing to the occurrence of one or both conditions, specifying the occurred condition or conditions.

This Guarantee will remain in force upto and including the date (No of days as mentioned in tender enquiry) days after the closing date of submission of bids as stated in the Invitation to Bid or as extended by you at any time prior to this date, notice of which extension to the Bank being hereby waived, and any demand in respect thereof should reach the Bank not later than the above date.

DATE **SIGNATURE OF THE BANK**

WITNESS **SEAL**

(Signature, Name & Address) (At least 2 witnesses)

Doc. Title	GENERAL CONDITIONS OF CONTRACT FOR SUPPLY ORDERS	
Rev. No	3	Page 32 of 48

ANNEXURE- B

PROFORMA FOR PERFORMANCE BANK GUARANTEE (CP cum EP)

(On Rs.100/- Stamp Paper) Note:

- a) Format shall be followed in toto
- b) Claim period of one month must be kept up
- c) The guarantee to be accompanied by the covering letter from the bank confirming the signature to the guarantee

**The TP Central Odisha Distribution Limited
Berhampur**

CP cum EP BG No.....

Order/Contract No.....dated.....

1. You have entered into a Contract No _____ with M/s. _____ (hereinafter referred to as "the Vendor"/ 'BA')) for the supply of _____ (hereinafter referred to as" the said Equipment") for the price and on the terms and conditions contained in the said contract.
2. In accordance with the terms of the said contract, "the Vendor" agreed to furnish you with an irrevocable, unconditional and acceptable bank guarantee for ____% of the value of contract and to be valid till the end of Guarantee period plus one month towards "Contract cum Equipment performance". For this purpose you have agreed to accept the guarantee.
3. In consideration thereof, we, _____ hereby irrevocably and unconditionally guarantee to pay to you on demand but in any case before the end of five working days from the date of the claim and without demur and without reference to "the Vendor" such amount or amounts not exceeding the sum of Rs. _____ (Rupees _____ only) being _____% (_____ percent) of the total value of the contract on receipt of your intimating that "the Vendor" has not fulfilled his contractual obligations. You shall be the sole judge for such non-fulfillment and "the Vendor" shall have no right to question such judgment.
4. You shall have the right to file / make your claim on us under the guarantee for a **further period of one month** from the date of expiry.
5. This guarantee shall not be revoked without express consent and shall not be affected by your granting time or any other indulgence to "the Vendor", which shall include but not be limited to, postponement from time to time of the exercise the same in you or any right which you may have against "the Vendor" and to exercise the same in any covenant contained or implied in the said contract or any other course or remedy or security available to you, and our Bank shall not be released from its obligations under this guarantee by your exercising any of your rights with

Doc. Title	GENERAL CONDITIONS OF CONTRACT FOR SUPPLY ORDERS	
Rev. No	3	Page 33 of 48

reference to matters aforesaid or any of them or by reasons of any other act or forbearance or other acts of omission or commission on your part or any other indulgence shown by you or by any other matter or thing whatsoever which under the law would, but for this provision have the effect of relieving our bank from its obligation under this guarantee.

6. We also agree that you shall be entitled at your option to enforce this guarantee against our bank as a principal debtor, in the first instance, notwithstanding any other security or guarantee that you may have in relation to "the Vendor's" liabilities in respect of the premises
7. This guarantee shall not be affected by any change in the constitution of our Bank or "the Vendor" or for any other reason whatsoever.
8. Any claim / extension under the guarantee can be lodge-able at Berhampur branch of the bank. However, in specific scenario, where Treasury Branch of the bank is not available at Berhampur, then any claim / extension under the guarantee can be lodge-able at Bhubaneswar branch of the bank.
9. Notwithstanding anything herein contained, our liability under this guarantee is limited to Rs. _____ (Rupees _____) only and the guarantee will remain in force upto and including _____ (Date) and shall be extended from time to time for such period or period as may be desired by "the Vendor".
10. Unless a demand or claim under this guarantee is received by us in writing within one months from _____ (expiry date) i.e. on or before _____ (claim period end date), we shall be discharged from all liabilities under this guarantee thereafter.

Dated at _____ this _____ day of _____ 20__

Bank's rubber stamp

1. Banks full address

Designation of Signatory

2. Bank official number

Doc. Title	GENERAL CONDITIONS OF CONTRACT FOR SUPPLY ORDERS	
Rev. No	3	Page 34 of 48

ANNEXURE-C

PROFORMA FOR “NO DEMAND CERTIFICATE” BY ASSOCIATE

(On Company's Letter head or with Company Seal)

(To be submitted by the Associate to TPSODL Accounts Department at the time of receipt of full and final payment)

(Certificate No. CCP/002)

Name of the Project Order/

Contract No.

Dated

Name of the Associate Scheme

No. / Job No.

We, M/s. _____ (Associate) do hereby acknowledge and confirm that we have received the full and final payment due and payable to us from TPSODL, in respect of our aforesaid Order No _____ dated _____ including amendments, if any, issued by TPSODL to our entire satisfaction and we further confirm that we have no claim whatsoever pending with TPSODL under the said contract / W.O.

Notwithstanding any protest recorded by us in any correspondence, documents, measurement books and / or final bills etc., we waive all our rights to lodge any claim or protest in future under this contract.

We are issuing this “NO DEMAND CERTIFICATE” in favour of TPSODL, with full knowledge and with our free consent without any undue influence, misrepresentation, coercion etc.

Place

Name

(Company Seal)

Doc. Title	GENERAL CONDITIONS OF CONTRACT FOR SUPPLY ORDERS	
Rev. No	3	Page 35 of 48

ANNEXURE-D

**PROFORMA FOR APPLICATION FOR ISSUANCE OF CONSOLIDATED TDS
CERTIFICATE**

To be printed on the letterhead

To,

The TP Southern Odisha Distribution Limited,

Berhampur

Sub: Application for issuance of Consolidated TDS Certificate for the FY _____

Dear Sir,

I / we hereby request / authorize you to issue me / us a consolidate TDS Certificate for the financial year _____ against tax deducted at source by you from my / our payments / bills during the said year from time to time under Chapter XVII – B of the Income Tax Act, 1961. For and on behalf of

Signature

Name

Address

Contact No. (Land Line)

(Mobile)

PAN #

Assessing authority

ATTACH THE COPY OF PAN CARD

Doc. Title	GENERAL CONDITIONS OF CONTRACT FOR SUPPLY ORDERS	
Rev. No	0	Page 36 of 48

ANNEXURE-E

BUSINESS ASSOCIATE FEEDBACK FORM

With an objective to improve our internal processes and systems, and serve you better, we solicit your valuable feedback & suggestions. It is estimated that it will take about 10 minutes to complete this survey. We assure you that your feedback shall be kept confidential. Please send the duly filled feedback form in the "TPSODL addressed - attached envelop"

You are associated with us as

- OEMs Service Contractor Material Suppliers Material & Manpower Supplier

You are associated with us for

- Less than 1 year More than 1 year but less than 3 years More than 3 years

Your office is located at

- Berhampur Within 200 kms from Berhampur More than 200 kms from Berhampur

Your nearly turnover with TPSODL

- Less than 25 Lacs 25 Lacs to 1 Crore More than 1 Cr.

Additional Information

Your Name	
Your Designation	
Your Organization	
Contact Nos.	
Email	

We once again thank you for your participation in this survey. Please spare 10 minutes to give your feedback on following pages (Section A to E)

SECTION – A

(Please ✓ mark in the relevant box and give your remarks / suggestions / information for our improvement).

S. No.	Parameters	1	2	3	4	5	Remarks/ Suggestion
		Do Not Agree	Slightly in Agreement	In Fair Agreement	Mostly in Agreement	Fully Agree	
1	You receive all relevant queries / tenders from us in timely manner.						
2	We provide you enough lead time to respond to our queries / tenders.						
3	We provide you adequate support (drawings, documents, clarifications, briefing etc.) to enable you meet our requirements.						
4	All following elements of our contract / purchase order are rational :						
4.1	Scope of Work						
4.2	Delivery / Execution Schedule						
4.3	Payment Terms						
4.4	Liquidated Damages						
4.5	Performance Guarantee						
5	Our purchase orders / contracts are simple, specific & easy to understand						
6	TPSODL demonstrate willingness to be flexible in administration of Contract / Purchase Order						
7	We provide timely responses / clarifications to your queries						
8	TPSODL representative you interact / coordinate with is adequately empowered to support you in meeting contractual obligations						
9	TPSODL provide you all necessary infrastructure support for timely and quality completion of work (including AMC)						
10	TPSODL Engineer-in-Charge timely certifies the jobs executed/ material supplied						
11	TPSODL Engineer-in-Charge efficiently supervises the job execution for timely completion of job						
12	BIRD (Bill Inward Receipt Desk) initiative has improved payment disbursement process* (under development)						

S. No.	Parameters	1	2	3	4	5	Remarks/ Suggestion
		Do Not Agree	Slightly in Agreement	In Fair Agreement	Mostly in Agreement	Fully Agree	
13	Our approach for Inspection and Quality Assurance effective to expedite project completion?						
14	TPSODL never defaults on contractual terms						
15	In TPSODL Contracts closure is done within set time limit						
16	Our material receiving procedures are well defined and efficiently deployed to reduce mutual inconvenience						
17	Bank Guarantees are released in time bound manner						
18	Our processes related to payment / account settlement are effective.						
19	You get payments on time						
20	TPSODL Employees follow Ethical behaviour						

SECTION – B

SECTION – B (Please rate the following parameters on a scale of 1 to 5, where 1 - Minimum; 5 - Maximum)

S. No.	Parameters	1	2	3	4	5	Remarks/ Suggestion
1	How do you rate courtesy/ empathy/ attitude level and warmth of TPSODL employees you interact with from following team?						
1.1	Project Engineering						
1.2	District / Zones						
1.3	Projects/HOG (TS &P)						
1.4	Inspection & Quality Assurance						
1.5	Stores						
1.6	Metering & Billing						
1.7	Accounts / Finance						
1.8	Administration						
1.9	IT & Automation						
2	How would you rate TPSODL in comparison						

	to your other clients in terms of fairness of treatment and transparency with its Business Associates?						
3	How would you rate TPSODL in comparison to your other clients in terms of processes and systems to manage partnership with its Business Associates						
4	How would you rate TPSODL in comparison to your other clients in terms of building long term & mutually relationship with its Business Associates						

SECTION - C

Please √ mark in the relevant box and give your remarks / suggestions / information for our improvement.

S. No.	Parameters	Certainly No	Probably No	Certainly Yes	Probably Yes	Remarks/ Suggestion
1	Based on your experience with TPSODL, would you like to continue your relationship with TPSODL?					
2	If someone asks you about TPSODL, would you talk "positively" about TPSODL?					
3	Would you refer TPSODL name to others in your community, fraternity and society as a professional & dynamic organization?					

SECTION - D

If we ask you to rate us on a scale of 1 to 10, how will you rate TPSODL, that truly represents your overall satisfaction with us (please tick appropriate box) -

1	2	3	4	5	6	7	8	9	10
---	---	---	---	---	---	---	---	---	----

SECTION - E

Please √ mark in the relevant box and give your remarks / suggestions / information for our improvement.

Doc. Title	GENERAL CONDITIONS OF CONTRACT FOR SUPPLY ORDERS	
Rev. No	3	Page 40 of 48

Please spare your thoughts for TPSODL's improvement in particular areas of weaknesses, particularly relating to some great practices, attitudes that you have seen elsewhere in Indian and International Organizations, which you recommend TPSODL to adopt. Please give your valuable salient recommendations.

Please spare your thoughts for TPSODL's improvement in particular areas of major concerns for you. We also welcome your suggestions to adopt any best practices, altitudes that you

Recommendation	<i>Please tick (√) your top 5 expectations out of the following 10 points listed below -</i>	
(Please list down improvement you expect from TPSODL)	<i>Timely payment</i>	
1	<i>Flexibility in Contracts/PO</i>	
	<i>Clarity in PO,s & Contracts</i>	
2	<i>Timely response to quarries</i>	
	<i>Timely certification of works executed</i>	
3	<i>Clarity in Specs, drawings, other docs etc.</i>	
	<i>Adequate information provided on website for tender notification, parties qualified etc.</i>	
4	<i>Timely receipt of material at site for execution</i>	
	<i>Performance Guarantee/EMD released in time</i>	
5	<i>Inspection & quality assurance support for timely job completion</i>	

We thank you for your time and courtesy!!

Doc. Title	GENERAL CONDITIONS OF CONTRACT FOR SUPPLY ORDERS	
Rev. No	3	Page 41 of 48

ANNEXURE-F

ACCEPTANCE FORM FOR PARTICIPATION IN REVERSE AUCTION EVENT

(To be signed and stamped by the bidder prior to participation in the auction event)

In a bid to make our entire procurement process more fair and transparent, TPSODL intends to use the reverse auctions through SAP-SRM tool as an integral part of the entire tendering process. All the bidders who are found as technically qualified based on the tender requirements shall be eligible to participate in the reverse auction event.

The following terms and conditions are deemed as accepted by the bidder on participation in the bid event:

1. TPSODL shall provide the user id and password to the authorized representative of the bidder. (Authorization Letter in lieu of the same shall be submitted along with the signed and stamped Acceptance Form).
2. TPSODL will make every effort to make the bid process transparent. However, the award decision by TPSODL would be final and binding on the supplier.
3. The bidder agrees to non-disclosure of trade information regarding the purchase, identity of TPSODL, bid process, bid technology, bid documentation and bid details.
4. The bidder is advised to understand the auto bid process to safeguard themselves against any possibility of non-participation in the auction event.
5. In case of bidding through Internet medium, bidders are further advised to ensure availability of the entire infrastructure as required at their end to participate in the auction event. Inability to bid due to telephone line glitch, internet response issues, software or hardware hangs, power failure or any other reason shall not be the responsibility of TPSODL.
6. In case of intranet medium, TPSODL shall provide the infrastructure to bidders. Further, TPSODL has sole discretion to extend or restart the auction event in case of any glitches in infrastructure observed which has restricted the bidders to submit the bids to ensure fair & transparent competitive bidding. In case an auction event is restarted, the best bid as already available in the system shall become the start price for the new auction.
7. In case the bidder fails to participate in the auction event due any reason whatsoever, it shall be presumed that the bidder has no further discounts to offer and the initial bid as submitted by the bidder as a part of the tender shall be considered as the bidder's final no regret offer. Any offline price bids received from a bidder in lieu of non-participation in the auction event shall be out rightly rejected by TPSODL.
8. The bidder shall be prepared with competitive price quotes on the day of the bidding event.
9. The prices as quoted by the bidder during the auction event shall be inclusive of all the applicable taxes, duties and levies and shall be FOR at TPSODL site.
10. The prices submitted by a bidder during the auction event shall be binding on the bidder.
11. No requests for time extension of the auction event shall be considered by TPSODL.
12. The original price bids of the bidders shall be reduced on pro-rata basis against each line item based on the final all inclusive prices offered during conclusion of the auction event for arriving at Contract amount.

Signature & Seal of the Bidder

Doc. Title	GENERAL CONDITIONS OF CONTRACT FOR SUPPLY ORDERS	
Rev. No	3	Page 43 of 48

Name of the Authorized Signatory: _____ :

Contact Person's Name:

Official Correspondence Address:

We confirm that we will bear the charges, if any, levied by our bank for the credit of NEFT/RTGS amounts in our account. Any change in above furnished information shall be informed to TPSODL well in time at our own. Further, we kept TPSODL indemnified for any loss incurred due to wrong furnishing of above information.

Thanking you,

For _____

(Authorised Signatory)

(Signature with Rubber Stamp)

Certification from Bank:

We confirm that we are enabled for receiving NEFT/RTGS credits and we further confirm that the account number (specify Bank a/c no.) of (Please mention here name of the account holder), the signature of the authorised signatory and the MICR and IFSC Code of our branch mentioned above are correct.

This also is certified that the above information is correct as per Bank record

(Manager's/ Officers Signature under Bank Stamp)

ANNEXURE-H
VENDOR APPRAISAL FORM

TO BE SUBMITTED BY VENDOR (To be filled as applicable)			
VENDOR:			
1.0	DETAILS OF THE FIRM		
	1.1	NAME (IN CAPITAL LETTERS)	:
	1.2	TYPE OF CONCERN (PROPRIETARY) Partnership, Pvt. Ltd., Public Ltd. etc.	:
	1.3	YEAR OF ESTABLISHMENT	:
	1.4	LOCATION OF OFFICE POSTAL ADDRESS TELEGRAPHIC ADDRESSES, TELEX NO. FAX NO.	:
	1.5	LOCATION OF MANUFACTURING UNITS	:
		i) UNITS 1	:
		ii) OTHER UNITS	:
2.0	PRODUCTS MANUFACTURED		
3.0	TURNOVER DURING THE LAST 3 YEARS (TO BE VERIFIED WITH THE LATEST PROFIT & LOSS STATEMENT).		
4.0	VALUE OF FIXED ASSETS		
5.0	NAME & ADDRESS OF THE BANKERS		
6.0	BANK GUARANTEE LIMIT		
7.0	CREDIT LIMIT		
8.0	TECHNICAL		
	8.1	NO. OF DESIGN ENGINEERS (INDICATE NO. OF YEARS EXPERIENCE IN RELATED FIELDS)	:
	8.2	NO. OF DRAUGHTS MEN	:
	8.3	COLLABORATION DETAILS (IF ANY)	:
		8.3.1 DATE OF COLLABORATION	:
		8.3.2 NAME OF COLLABORATOR	:
		8.3.3 RBI APPROVAL DETAILS	:
		8.3.4 EXPERIENCE LIST OF COLLABORATOR	:
		8.3.5 DURATION OF AGREEMENT	:
	8.4	AVAILABILITY OF STANDARDS / DESIGN PROCEDURES / COLLABORATOR'S /	:

		DOCUMENTS (CHECK WHETHER THESE ARE LATEST/CURRENT	
	8.5	TECHNICAL SUPPORT, BACK-UP GUARANTEE, SUPERVISION, QUALITY CONTROL BY COLLABORATOR (WHEREVER ESSENTIAL). (THIS CLAUSE IS RELEVANT WHEN VENDOR'S EXPERIENCE IS INADEQUATE)	:
	8.6	QUALITY OF DRAWINGS	:
9.0	MANUFACTURE		
	9.1	SHOP SPACE, LAYOUT LIGHTING, VENTILATION, ETC.	:
	9.2	POWER (KVA)	:
		MAINS INSTALLED	:
		UTILIZED	:
		STANDBY POWER SOURCE	:
	9.3	MANUFACTURING FACILITIES (ATTACH LIST OF EQUIPMENT AS APPLICABLE)	:
		9.3.1 MATERIAL HANDLING	:
		9.3.2 MACHINING	:
		9.3.3 FABRICATION	:
		9.3.4 HEAT TREATMENT	:
		9.3.5 BALANCING FACILITY	:
		9.3.6 SURFACE TREATMENT PRIOR TO PAINTING/ COATING, POLISHING, PICKLING, PASSIVATION, PAINTING, ETC.	:
	9.4	SUPERVISORY STAFF	:
	9.5	ADEQUACY OF SKILLED LABOURS (MACHINISTS, WELDERS, ETC.)	:
	9.6	NO. OF SHIFTS	:
	9.7	TYPE OF MATERIAL HANDLED (SUCH AS CS, SS, ETC.)	:
	9.8	WORKMANSHIP	:
	9.9	MATERIAL IN STOCK AND VALUE	:
	9.10	TRANSPORT FACILITIES	:
	9.11	CARE IN HANDLING	:
10.0	INSPECTION / QC / QA / TESTING		
	10.1	NUMBER OF PERSONNEL (INDICATE NO. OF YEARS OF EXPERIENCE)	:
	10.2	INDEPENDENCE FROM PRODUCTION	:

Doc. Title	GENERAL CONDITIONS OF CONTRACT FOR SUPPLY ORDERS	
Rev. No	3	Page 46 of 48

	10.3	AVAILABILITY OF PROCEDURAL WRITE UP/QUALITY PLAN	:
	10.4	INCOMING MATERIAL CONTROL AND DOCUMENTATION	:
	10.5	RELIABILITY/REPUTATION OF SUPPLY SOURCES	:
	10.6	STAGE INSPECTION AND DOCUMENTATION	:
	10.7	SUB-ASSEMBLY & DOCUMENTATION	:
	10.8	FINAL INSPECTION AND DOCUMENTATION	:
	10.9	PREPARATION OF FINAL DOCUMENTATION PACKAGE	:
	10.10	TYPE TEST FACILITIES	:
	10.11	ACCEPTANCE TEST FACILITIES	:
	10.12	CALIBRATION OF INSTRUMENTS AND GAUGES (WITH TRACEABILITY TO NATIONAL STANDARDS) (ATTACH LIST)	:
	10.13	STATUTORY APPROVALS LIKE BIS, IBR, ETC.(AS APPLICABLE)	:
	10.14	SUB-VENDOR APPROVAL SYSTEM AND QUALITY CONTROL	:
	10.15	DETAILS OF TESTS CARRIED OUT AT INDEPENDENT RECOGNIZED LABORATORIES	:
		i) FURNISH LIST OF TESTS CARRIED OUT AND THE NAME OF THE LABORATORY WHERE THE TESTS WERE CONDUCTED	:
		ii) CHECK AVAILABILITY OF CERTIFICATES AND REVIEW THESE WHEREVER POSSIBLE	:
11.0		EXPERIENCE (INCLUDING CONSTRUCTION / ERECTION / COMMISSIONING) TO BE FURNISHED IN THE FORMAT INDICATED IN APPENDIX)	:
12.0		SALES, SERVICE AND SITE ORGANIZATIONAL DETAILS	:
13.0		CERTIFICATE FROM CUSTOMERS (ATTACH COPIES OF DOCUMENTS)	:
14.0		POWER SITUATION	:
15.0		LABOUR SITUATION	:
16.0 *		APPLICABILITY OF SC/ST RELAXATION (Y/N) IF YES, SUPPORTING DOCUMENTS TO BE ATTACHED	
17.0		ORGANIZATIONAL DETAILS 1. PF NO 2. ESI NO 3. INSURANCE FOR WORK MAN COMPENSATION ACT NO 4. ELECTRICAL CONTRACT LIC NO 5. ITCC / PAN NO 6. SALES TAX NO 7. WC TAX REG. NO	:
18.0		DOCUMENTS TO BE ENCLOSED:	

Doc. Title	GENERAL CONDITIONS OF CONTRACT FOR SUPPLY ORDERS	
Rev. No	3	Page 47 of 48

	<ol style="list-style-type: none"> 1. FACTORY LICENSE 2. ANNUAL REPORT FOR LAST THREE YEARS 3. TYPE TEST REPORT FOR THE ITEM 4. PAST EXPERIENCE REPORTS 5. ISO CERTIFICATE –QMS, EMS, OHAS, SA 6. REGISTRATION OF SALES TAX 7. COPY OF TIN NO. 8. COPY OF SERVICE TAX NO. 9. REGISTRATION OF CENTRAL EXCISE 10. COPY OF INCOME TAX CLEARANCE. 11. COPY OF PF REGISTRATION 12. COPY OF ESI REGISTRATION 13. COPY OF INSURANCE FOR WORK MAN COMPENSATION ACT NO 14. COPY OF ELECTRICAL CONTRACT LIC NO 15. COPY OF PAN NO 16. COPY OF WC TAX REGISTRATION 17. DOCUMENTS IN SUPPORT OF SC/ST RELAXATION AT S.NO.16.0 18. GSTN CERTIFICATE 	
--	--	--

*** Classification of BA s under SC/ST shall be governed under following guidelines:**

- **Proprietorship/ Single Ownership Firm:** Proprietor of the firm should be from SC/ST community. Governing document shall be Proprietorship Deed.
- **Partnership Firm:** Only such firms shall qualify which have SC/ST partners holding equal to or more than 50% of the total ownership pattern of the firm. Governing document shall be Partnership Deed.
- **Private Limited Company:** Only such firms shall qualify which have SC/ST directors holding equal to or more than 50% of the total ownership pattern of the firm. Governing document shall be Memorandum of Understanding (MoU) and/or Article of Association (AoA).

NOTE: Certification from SC/ST Commission shall be required for deciding upon SC/ST status of a person.

Doc. Title	GENERAL CONDITIONS OF CONTRACT FOR SUPPLY ORDERS	
Rev. No	3	Page 48 of 48

ANNEXURE-I
MANUFACTURER AUTHORIZATION FORM

(To be submitted on OEM's Letter Head)

Date:

Tender Enquiry No.:

To,
Chief (Contracts & Stores)
The TP Southern Odisha Distribution Limited,
Berhampur.

Sir,

WHEREAS M/s. *[name of OEM]*, who are official manufacturers of having factories at *[address of OEM]* do hereby authorize M/s *[name of bidder]* to submit a Bid in relation to the Invitation for Bids indicated above, the purpose of which is to provide the following Goods, manufactured by us

.....and to subsequently negotiate and sign the Contract.

We hereby extend our full guarantee and warranty in accordance with the Special Conditions of Contract or as mentioned elsewhere in the Tender Document, with respect to the Goods offered by the above firm in reply to this Invitation for Bids.

We hereby confirm that in case, the channel partner fails to provide the necessary services as per the Tender Document referred above, M/s *[name of OEM]* shall provide standard warranty on the materials supplied against the contract. The warranty period and inclusion / exclusion of parts in the warranty shall remain same as defined in the contract issued to their channel partner against this tender enquiry.

Yours Sincerely,

For

Authorized Signatory

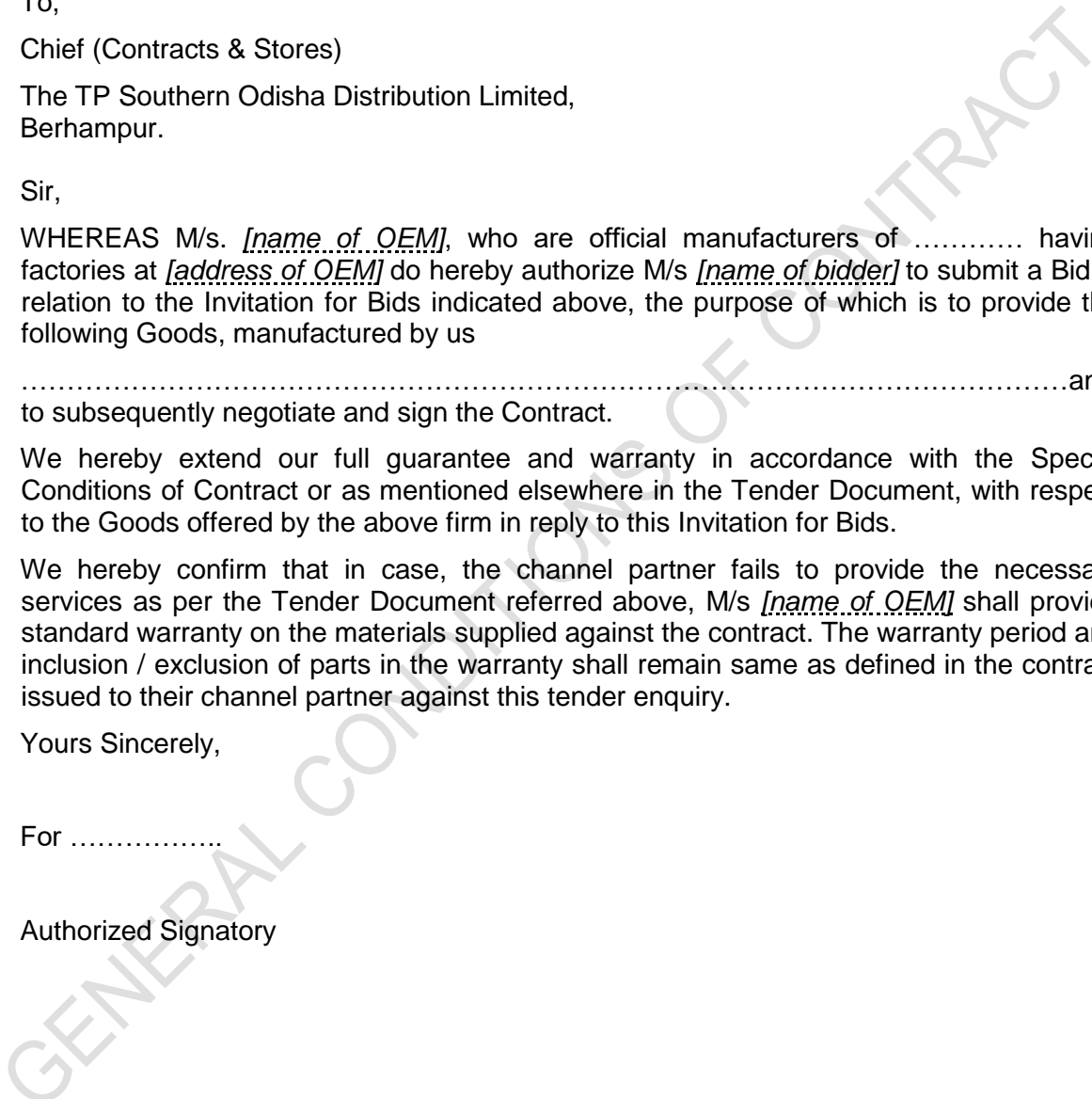

**CONTENTS**

CLAUSE NO.	DESCRIPTION
1.0	ORGANIZATIONAL VALUES
2.0	ETHICS
3.0	CONTRACT PARAMETERS
3.1	Issue/Award of Contract
3.2	Contract Commencement Date
3.3	Contract Completion Date
3.4	Contract Period/ Time
3.5	Contract Execution Completion Date
3.6	Contract Price /Value
3.7	Contract Document
3.8	Contract Language
3.9	Reverse Auction
4.0	SCOPE OF WORK
5.0	PRICES/RATES/TAXES
5.1	Changes in statutory Tax Structure
6.0	TERMS OF PAYMENT
6.1	Quantity Variation
6.2	Full and Final Payment
7.0	MODE OF PAYMENT
8.0	SECURITY CUM PERFORMANCE DEPOSIT
9.0	STATUTORY COMPLIANCE
9.1	Compliance to Various Acts
9.2	SA 8000
9.3	Affirmative Action
10.0	QUALITY
10.1	Knowledge of Requirements
10.2	Material/Equipment/Works Quality
10.3	Adherence to Rules & Regulations
10.4	Specifications and Standards
11.0	INSPECTION/PARTICIPATION
11.1	Right to Carry Out Inspection
11.2	Facilitating Inspection
11.3	Third Party Nomination
11.4	Waiver of Inspections
11.5	Incorrect Inspection Call

CONTENTS	
CLAUSE NO.	DESCRIPTION
12.0	MDCC & DELIVERY OF MATERIALS
12.1	Material Dispatch Clearance Certificate
12.2	Right to Rejection on Receipt
12.3	Consignee
12.4	Submission of Mandatory Documents on Delivery
12.5	Dispatch and Delivery Instructions
13.0	GUARANTEE
13.1	Guarantee of Performance
13.2	Guarantee period
13.3	Failure in Guarantee period (GP)
13.4	Cost of repairs on failure in GP
13.5	Guarantee Period for Goods Outsourced
13.6	Latent Defect
13.7	Support beyond the Guarantee Period
14.0	LIQUIDATED DAMAGES
14.1	LD Waiver Request
15.0	UNLAWFUL ACTIVITIES
16.0	CONFIDENTIALITY
16.1	Documents
16.2	Geographical Data
16.3	Associate's Processes
16.4	Exclusions
16.5	Violation
17.0	INTELLECTUAL PROPERTY RIGHTS
18.0	INDEMNITY
19.0	LIABILITY & LIMITATIONS
19.1	Liability
19.2	Limitation of Liability
20.0	FORCE MAJEURE
21.0	SUSPENSION OF CONTRACT
21.1	Suspension for Convenience
21.2	Suspension for Breach of Contract Conditions
21.3	Compensation in lieu of Suspension
22.0	TERMINATION OF CONTRACT
22.1	Termination for Default/Breach of Contract
22.2	Termination for Convenience of Associate
22.3	Termination for Convenience of TPWODL

Doc. Title	GENERAL CONDITIONS OF CONTRACT FOR SUPPLY ORDERS	
Rev. No	0	Page 3 of 44

CONTENTS	
CLAUSE NO.	DESCRIPTION
23.0	DISPUTE RESOLUTION AND ARBITRATION
23.1	Governing Laws and jurisdiction
24.0	ATTRIBUTES OF GCC
24.1	Cancellation
24.2	Severability
24.3	Order of Priority
25.0	ERRORS AND OMISSIONS
26.0	TRANSFER OF TITLES
27.0	INSURANCE
28.0	SUGGESTIONS & FEEDBACK
29.0	CONTACT POINTS
30.0	LIST OF ANNEXURES

GENERAL CONDITIONS OF CONTRACT

Doc. Title	GENERAL CONDITIONS OF CONTRACT FOR SUPPLY ORDERS	
Rev. No	0	Page 4 of 44

1.0 ORGANIZATIONAL VALUES

The Tata Group has always been a value driven organization. These values continue to direct the Group's growth and businesses. The six core Tata Values underpinning the way we do business are:

Integrity - We must conduct our business fairly, with honesty and transparency. Everything we do must stand the test of public scrutiny.

Understanding - We must be caring, respectful, compassionate and humanitarian towards our colleagues and customers around the world and always work for the benefit of India.

Excellence - We must constantly strive to achieve the highest possible standards in our day to day work and in the quality of goods and services we provide.

Unity - We must work cohesively with our colleagues across the group and with our customers and partners around the world to build strong relationships based on tolerance, understanding and mutual co-operation.

Responsibility - We must continue to be responsible and sensitive to the countries, communities and environments in which we work, always ensuring that what comes from the people goes back to the people many times over.

Agility - We must work in a speedy and responsive manner and be proactive and innovative in our approach.

2.0 ETHICS

In our effort towards Excellence and in Management of Business Ethics at TPWODL, an Ethics Management Team is constituted.

The main objective of the Ethics Management Team is to:

1. Record, address and allay the issues and concerns on ethics raised by different stakeholders like employees, consumers, vendors, Associates etc. by initiating immediate corrective actions.
2. Ensure proper communication of the ethics policies and guidelines through prominent displays at all offices of TPWODL and through printed declarations in all concerned documents where external stakeholders are involved.
3. Ensure proper framework of policies as preventive measures against any ethics violation recorded by them.
4. Prepare and submit MIS of all issues and concerns, corrective and preventive actions on monthly basis to the top management for their information.

All Associates and Stakeholders are requested to register any grievance on ethics violation on our website www.tatapower.com

3.0 CONTRACT PARAMETERS

3.1 Issue/Award of Contract

TPWODL awards the contract to the Associate in writing in the form of Purchase Order (PO) or Rate Contract (RC), hereafter referred as Contract, through in any or all of following modes physical handover / post / e-mail / web document / fax with all the attachments/enclosures which shall be part of the contract document.

Doc. Title	GENERAL CONDITIONS OF CONTRACT FOR SUPPLY ORDERS	
Rev. No	0	Page 5 of 44

On receipt of the contract, the associate shall return to TPWODL copy of the contract document duly signed by legally authorized representative of associate, within two days of Effective Date of Contract for contracts having contract execution time less than 30 days and within five days for all other contracts.

3.2 Contract Commencement Date

The date of issue/award of contract shall be the Effective Date of Contract or Contract Commencement date.

3.3 Contract Completion Date

The date of expiry of Guarantee Period shall be deemed as the Contract Completion Date.

3.4 Contract Period/Time

The period from Contract Commencement Date to Contract Completion Date shall be deemed as the Contract Period/Time.

3.5 Contract Execution Completion Date

The stipulated date for completing the supply as per schedule of quantities shall be deemed as the Contract Execution Completion Date.

3.6 Contract Price /Value

The total all inclusive price/value mentioned in the PO/RC is the Contract Price/Value and is based on the quantity, unit rates and prices quoted and awarded and shall be subject to adjustment based on actual quantities supplied and accepted and certified by the authorized representative of the company unless otherwise specified in schedule of quantities or in contract documents.

3.7 Contract Document

The Contract Document shall mean and include but not limited to the following:

- NIT/Tender Enquiry, QR, Instruction to Bidders, Special Condition of Contract (SCC) of tender, GCC, Technical & Commercial Specifications including relevant annexure and attachments).
- Bids & Proposals Received from Associate including relevant annexure/attachments.
- RC/PO with agreed deviations from the tender/bid documents.
- All the Inspection and Test reports, Detailed Engineering Drawings.
- Material Dispatch Clearance Certificate (MDCC).
- Minutes of Meeting (MoM)

3.8 Contract Language

All documents, instructions, catalogues, brochures, pamphlets, design data, norms and calculations, drawings, operation, maintenance and safety manuals, reports, labels, on deliveries and any other data shall be in English Language.

The Contract documents and all correspondence between the TPWODL, Third Parties associated with the contract, and the Associate shall be in English language.

However, all signboards required indicating "Danger" and/or security at site and otherwise statutory required shall be in English, Hindi, and local languages.

Doc. Title	GENERAL CONDITIONS OF CONTRACT FOR SUPPLY ORDERS	
Rev. No	0	Page 6 of 44

3.9 Reverse Auction

TPWODL reserves the right to conduct the reverse auction (instead of public opening of price bids) for the products / services being asked for in the tender. The terms and conditions for such reverse auction events shall be as per the Acceptance Form attached in Annexure F. The bidders along with the tender document shall mandatorily submit a duly signed copy of the Acceptance Form as mentioned in the Annexure J as a token of acceptance for the same.

4.0 SCOPE OF WORK

All the activities that are to be undertaken by the Associate to realize the contractual deliverables in completeness form Scope of Work. Following clauses list, but not limited to, major requirements of the scope of work.

The associate shall satisfy himself and undertake fully the technical/commercial requirements of items to be supplied as listed in the Schedule of Quantities together with the tests to be performed /test reports to be furnished before dispatch, arrangement of stage and final inspections during manufacturing as per terms and conditions of contract, technical parameters & delivery terms and conditions including transit insurance to be met in order to fully meet TPWODL's requirements.

Completeness: Any supplies and services which might have not been specifically mentioned in the Contract but are necessary for the scope mentioned in Special Terms & Conditions and/or completeness of the works at the highest possible level, including any royalties, license fees & compensation to be paid, whether incurred by the associates or by a third party for the work covered in the scope, regardless of when incurred, shall be supplied/provided by the associate without any extra cost and within the time schedule for efficient , smooth and satisfactory operation and maintenance of the works at the highest possible level under Indian conditions (but according to international standards for facility of this type), unless expressly excluded from the scope of supplies and services in this Contract.

TPWODL have the right, during the performance of the Contract, to change the scope and/or technical character of the Project and/or of the supplies and services stipulated in the Contract by submitting a request in writing to the Associate. The Associate shall, within fifteen days of receipt of such request from the TPWODL, provide Purchaser with a reasonably detailed estimate of the cost of the change outlined in the request.

In the event, TPWODL requests a change, the Contract price and time shall be adjusted upwards or downwards, as the case may be and shall be mutually agreed to. The associate shall not be entitled to any extension of time unless such changes adversely affect the time schedule.

The Associate shall not proceed with the changes as requested till adjustment of contract price and time schedule where so applicable in terms of or otherwise directed by the TPWODL.

5.0 PRICES/RATES/TAXES

Unless specified elsewhere in the contract document, the prices/rates are inclusive of cost of finished product for which MDCC will be issued by TPWODL, packaging and forwarding charges, freight and transit insurance charges covering loading at Associate's works, transportation to TPWODL store/site & unloading & delivery at TPWODL stores/TPWODL site, cost of documentation including all the relevant test certificates and other supportive documents to be furnished.

Doc. Title	GENERAL CONDITIONS OF CONTRACT FOR SUPPLY ORDERS	
Rev. No	0	Page 7 of 44

The Prices/Rates are inclusive of all taxes, levies, cess and duties, particularly Goods and Services Tax as applicable. All government levy / taxes shall be paid only when the invoice is submitted according to the relevant act.

The prices/rates shall remain firm till actual completion of entire supply of goods/material/equipment as per contract is achieved and shall remain valid till the completion of the contract.

The prices shall remain unchanged irrespective of TPWODL making changes in quantum in all or any of the schedules of items of contract.

5.1 Changes in Statutory Tax Structure

If rate of any or all of the statutory taxes and duties applicable to the contract changes, such changes shall be incorporated by default if the changes occur within the contract execution time and shall be applicable if the contract is executed by the Associate within the Contract Execution Time.

For execution of contracts beyond contract execution time, where the delay is not attributable to TPWODL no upward revision in tax /duties shall be considered irrespective of changes in the statutory tax structure either within the contract execution time or beyond. However, in such cases, benefits due to any downward revisions in statutory tax rates shall be passed on to TPWODL.

6.0 TERMS OF PAYMENT

On delivery of the materials in good condition and certification of acceptance by TPWODL official, Associate shall submit the Bills/Invoices in original in the name of "TP Western Odisha Distribution Ltd" to invoice desk, complete with all required documents as under:

- Test Reports (4 sets).
- MDCC issued by TPWODL.
- Packing List.
- Drawing and Catalogue.
- Guarantee/Warrantee Card.
- Delivery Challan.
- O&M Manual.
- Copy of Order.
- Minutes of Meeting.

Bills/ invoices shall mention Supplier's GST Number. TPWODL will make 100% payment within 30 days of submission of the Bill/Invoice complete in all respects and along with all the requisite documents mentioned above, subject to condition that Associate has furnished the requisite Security-cum-Performance Guarantee as stipulated in the contract.

6.1 Quantity Variation

Payment will be made on the basis of actual quantity of supplies/actual measurement of works accepted by TPWODL and not on the basis of contract quantity.

Doc. Title	GENERAL CONDITIONS OF CONTRACT FOR SUPPLY ORDERS	
Rev. No	0	Page 8 of 44

6.2 Full and Final Payment

Full & Final Payment in all contracts shall be made subject to the associate submitting “No Demand Certificate” in the format as per Annexure-C.

7.0 MODE OF PAYMENT

Payment shall be made through crossed Cheque or RTGS whichever of the two modes chosen by the Associate, in favour of Associate’s Bank Account on TPWODL records, on whose name Contract has been issued. Those Associates opting for the RTGS mode shall submit the details of Bank Account and other details as per annexure G. Further, for any payments made, TPWODL is not responsible for any consequences/disputes Associate have among the owners channel partners, sub-Associates and all such dispute/concerns shall be settled solely by the Associate.

8.0 SECURITY CUM PERFORMANCE DEPOSIT

Associates shall submit within 15 days from the effective date of issue of PO/RC, Security Performance Bank Guarantee (SPBG) in the format as per Annexure B of this document from banks acceptable to TPWODL for:

- (a) 5% of the PO value if purchase order value is more than Rs 5 Crores.
- (b) 10% of the PO value if purchase order value is less than Rs 5 Crores.

This shall remain valid till the end of the Guarantee Period of contract, plus one month.

- (c) 5% of the RC value in case of Rate Contract. This shall remain valid till the Guarantee period plus one month.

- For PO/RC values less than Rs. 5 lacs, Associate may request for deduction of amount equivalent to SPBG value from their first invoice. Such amount shall be withheld by TPWODL while processing the invoice and shall be released after completion of Guarantee Period plus one month.
- For PO/RC values less than Rs. 3 lacs, the clause (8.0) for Security cum Performance Bank Guarantee (SPBG) shall not be applicable.
- In case of RC (Rate Contract) after the expiry of RC validity, Associate shall have to submit SPBG. However, the Associate has the option to re-submit the SPBG as per actual RO (Release Order) value issued against the RC, valid for Guarantee Period plus one month. The Guarantee Period shall be considered as per the last RO issued against the said RC. The original SPBG as submitted against the RC shall be released on submission of the new SPBG to TPWODL. Alternatively, Associate may extend the validity of original SPBG only till the requisite period, i.e. Guarantee Period plus one month.

9.0 STATUTORY COMPLIANCE

9.1 Compliance to Various Acts

Associate should ensure adherence to all applicable laws, rules and regulation applicable under this contract from time to time. In case of violation any risk, costs etc shall be in associates account and keep TPWODL indemnified always till completion of contracts.

Doc. Title	GENERAL CONDITIONS OF CONTRACT FOR SUPPLY ORDERS	
Rev. No	0	Page 9 of 44

9.2 SA 8000

As TPWODL is SA 8000 compliant, it expects its Associates to follow guidelines of SA 8000:2014 on the following aspects

1. Child Labour
2. Forced or Compulsory Labour
3. Health & Safety
4. Freedom of Association & Right to Collective Bargaining
5. Discrimination
6. Disciplinary Practices
7. Working Hours
8. Remuneration
9. Management System

9.3 Affirmative Action

TPWODL appreciate and welcome the engagement/employment of persons from SC/ST community or any other deprived section of society by their business associates.

Relaxation in Contract Clauses under Affirmative Action for SC/ ST Business Associates**

TPWODL believes that inclusive growth is the key to sustainable development, and to promote the same Policy on Affirmative Action for Scheduled Caste & Scheduled Tribe Communities has been adopted across the company.

Under the same pre-text, and to promote entrepreneurship among SC/ST community TPWODL has taken initiative by proposing relaxations in contract clauses as per below:

S. No	Initiative	for SC/ ST BA's	Guideline Document
1	Tender Fees	100% waiver for SC/ST community	All Open Tenders
2	Earnest Money Deposit	50 % relaxation of estimated EMD value	All limited and Open Tenders
3	Performance Bank Guarantee	50% relaxation in PBG for order value above 50 lacs else 25% relaxation	All limited and Open tenders
4	Turnover	25% relaxation in company turnover under qualifying requirement criteria	All Open Tenders

**Classification of BAs under SC/ST shall be governed under following guidelines:

- Proprietorship/ Single Ownership Firm: Proprietor of the firm should be from SC/ST community. Governing document shall be duly audited balance Sheet for the last FY bearing the name of proprietor.
- Partnership Firm: Only such firms shall qualify which have SC/ST partners holding equal to or more than 50% of the total ownership pattern of the firm. Governing document shall be Partnership Deed and audited balance sheet/ ITR for last FY.
- Private limited company: Only such firms shall qualify which have SC/ST directors holding equal to or more than 50% of the total ownership pattern of the firm. Governing

Doc. Title	GENERAL CONDITIONS OF CONTRACT FOR SUPPLY ORDERS	
Rev. No	0	Page 10 of 44

document shall be Memorandum of Understanding (MoU) and/or Article of Association (AoA).

Governing document shall be Memorandum of Understanding (MoU) and/or Article of Association (AoA).

Note: Certification from SC/ST commission shall be required for deciding upon SC/ST status of a person.

10.0 QUALITY

10.1 Knowledge of Requirements

The Associate shall be deemed to have carefully examined and to have knowledge of the equipment, the general and other conditions, specifications, schedules, drawings, etc. forming part of the Contract and also to have satisfied himself as to the nature and character of the work to be executed and the type of the equipment and duties required including wherever necessary of the site conditions and relevant matters and details. Any information thus procured or otherwise obtained from TPWODL/Consultants shall not in any way relieve the Associate from his responsibility and executing the works in accordance with the terms of contract.

10.2 Material/Equipment/Works Quality

The items / works under the scope of the Associate shall be of the best quality and workmanship according to the latest engineering practice and shall be manufactured from materials of best quality considering strength and durability for their best performance and, in any case, in accordance with the specifications set forth in this Contract. All material shall be new. Substitution of specified material or variation from the process of fabrication/ construction/ manufacture may be permitted but only with the prior written approval of the TPWODL.

10.3 Adherence to Rules & Regulations

The Associate shall procure and/or fabricate/erect all materials and equipment in accordance with all requirements of Central and State enactment, rules and regulations governing such work in India and at site. This shall not be construed as relieving the Associate from complying with any requirement of TPWODL as enumerated in the Contract which may be more rigid than and not contrary to the above mentioned rules, nor providing such construction as may be required by the above mentioned rules and regulations. In case of variance of the Technical Specification from the laws, ordinance, rules and regulations governing the work, the Associate shall immediately notify the same to the TPWODL. It is the sole responsibility of the Associate, however, to determine that such variance exists. Wherever required by rules and regulations, the Associate shall also obtain the statutory authorities' approval for the plant, machinery and equipment to be supplied by the Associate.

10.4 Specifications and Standards

The Associate shall follow all codes and standards referred in the Contract Document. Codes and standards of other may be followed by the Associate with the prior written approval of TPWODL, provided materials, supplies and equipment according to the standard are equal to or better than the corresponding standards specified in the Contract.

Brand names mentioned in the Contract documents are for the purpose of establishing the type and quality of products to be used. The Associate shall not change the brand name and

Doc. Title	GENERAL CONDITIONS OF CONTRACT FOR SUPPLY ORDERS	
Rev. No	0	Page 11 of 44

qualities of the bought out items without the prior written approval of the TPWODL. All such products and equipment shall be used or installed in strict accordance with original manufacturer's recommendations, unless otherwise directed by the TPWODL. In any circumstances the codes, specimen and standards prescribed by any government agency should not be violated.

11.0 INSPECTION/PARTICIPATION

11.1 Right to Carry Out Inspection

TPWODL reserves the right to send its representatives for inspection or participation at various stages of contract execution listed below, applicable as per contract construction.

- During basic design and detail engineering of material/ Equipment carried out by Associate /Outsourced Agencies.
- During manufacturing stages of the product at Associate's/Associate's Outsourced Agency's Plant/Facility.
- During Pre-dispatch Inspection and Testing of finished/manufactured product at Associate's/Associate's outsourced Agency's Plant/Facility.
- During Installation & Commissioning Activities/Stages.
- Prior to Clearing of the completed installation for commissioning.
- Any other stage as find appropriate by TPWODL during contract execution time.

All inspections and participations shall be carried out by TPWODL giving written intimation to the Associate or receiving appropriate advance written inspection call from the Associate, unless otherwise specified elsewhere in the contract document.

11.2 Facilitating Inspection

The Associate shall provide all opportunities and information to TPWODL's engineers to get acquainted with the technical know-how and the methods and practices adopted by the Associate in basic and detail engineering. The Associate shall provide documents, drawings, calculations etc. as may be required by TPWODL's Engineers.

The Associate shall provide free of charge office accommodation, office facilities, secretarial services, communication facilities, general and drawing office stationary, etc. as may be reasonably required by the TPWODL's engineers. Similarly, facilities shall also be provided by Associate's outsource agencies/partners/authorized dealers (collectively termed as sub associates) if such basic and detail engineering activities are carried out in the design offices of sub-Associates.

The Associate shall be responsible for the safety of employees of TPWODL/Third Party Agency when they are at the Associate's /Associate's outsource agency's plant or facility for carrying out/witnessing inspection/testing. All statutory safety precautions as applicable shall be followed by the Associate during Inspection Testing. If TPWODL inspectors are not satisfied with the safety arrangements at the plant, TPWODL have the right to call off inspection till such time corrective action is taken by the Associate.

Before raising the call for pre-dispatch final inspection and testing, the Associate shall conduct all the tests—type tests, routine tests etc-as specified in the contract document and submit copies of the test certificates to TPWODL along with the inspection call, for scrutiny of TPWODL.

Doc. Title	GENERAL CONDITIONS OF CONTRACT FOR SUPPLY ORDERS	
Rev. No	0	Page 12 of 44

The Associate and TPWODL shall jointly document all the observations, comments and action points after completion of inspection and it shall be binding on the Associate to provide compliance on all the points requiring compliance and furnish the compliance report to the designated authority of TPWODL for receiving clearance for dispatch of materials

11.3 Third Party Nomination

TPWODL also may nominate a third party for the purpose of carrying out the inspection and such an agency shall be entitled to all the rights and privileges of TPWODL as far as conducting the inspection.

11.4 Waiver of Inspections

TPWODL on its own discretion shall chose to waive off any inspection and ask the Associate to submit all the test reports as applicable as per contract specifications, related to inspection and testing of the goods ordered for scrutiny and clearance for dispatch.

11.5 Incorrect Inspection Call

In case it is observed that the material offered for inspection is not ready at the time of TPWODL inspection visit rendering it as futile, all costs towards such inspection shall be recovered from the BA. Taxes as applicable on such recoveries shall be borne by the BA.

12.0 MDCC & DELIVERY OF MATERIALS

12.1 Material Dispatch Clearance Certificate

Associate shall deliver material/goods/equipment against Supply Contracts or Supply Part of Composite/Service Contracts only after receiving Material Dispatch Clearance Certificate (hereafter termed as MDCC) issued by designated authority of TPWODL. Material delivered at TPWODL stores or at project site without a valid MDCC issued by the designated official of TPWODL shall be rejected. MDCC shall be issued to associate furnishing compliance report on the action points documented during pre-dispatch inspection and testing at Associate's/ Sub Associate's plant/ facility. In case Pre-dispatch inspection is waived at the discretion of TPWODL, then, MDCC shall be issued on receiving all the test reports-routine& type-from the Associate and finding them in order.

The associate shall include and provide for securely protecting and packing the materials so as to avoid loss or damage during handling and transport by air, sea, rail and road or any other means.

All such packing shall allow to the extent possible for easy removal and checking at Site. The associate shall take special precautions to prevent rusting of steel and iron parts during transit by sea. Gas seals or other materials shall be utilized by the associate for protection against moisture during transit of all Plant and Equipment.

Each Equipment or parts of Equipment shall be tagged with reference to the assembly drawings and corresponding part numbers. Each bale or package shall contain a packing note quoting specifically the name of the associate, item description, quantity, item / package identification.

All packing cases, containers, packing and other similar materials shall be new and supplied free by the associate and it shall not be required to be returned to the associate.

Notwithstanding anything stated in this clause, the associate shall be entirely responsible for loss, damage or depreciation or deterioration to the materials and supplies due to faulty and/or insecure packing or otherwise during transportation to the Site until otherwise provided herein.

Doc. Title	GENERAL CONDITIONS OF CONTRACT FOR SUPPLY ORDERS	
Rev. No	0	Page 13 of 44

In case of the consignments dispatched by road, the associate shall ensure that it or its subcontractors:

- i) Identify and obtain the correct type of trucks/trailers, keeping in view the nature of consignments to be dispatched.
- ii) Take such actions as may be necessary to avoid all possible chances of damages during transit and to ensure that all packages are firmly secured.

Timelines for inspection and MDCC is as below:

S. No.	Inspection	MDCC issuance time including Inspection time (max.)
1	Outside Sambalpur	12 days
2	Within Sambalpur	5 days
3	Waiver*	3 working days

* Associate is expected to raise the inspection call assuming that Inspection shall be carried out by TPWODL. The decision for waiver of inspection shall be on sole discretion of TPWODL.

12.2 Right to Rejection on Receipt

Goods/Material/Equipment delivered in condition physically damaged & incomplete as a product ordered, or not packed and transported as per the terms and conditions of the contract is liable to be rejected. Such item shall be lifted back by Associates within 15 days from receipt of rejection note from TPWODL and have to supply back the material within next 30 days or within the timeframe mutually decided by Associate and TPWODL.

If delivery of the material is beyond the agreed time, Liquidated damage clause, mentioned in this GCC separately shall be applicable; but the period for levy of LD shall be considered as per the original delivery schedule and not from the agreed timelines for material rectification.

12.3 Consignee

Unless otherwise specified in the Contract Document, Materials/Goods/Equipment shall be consigned to "Stores-In-Charge", TPWODL, Burla.

12.4 Submission of mandatory documents on Delivery

Following documents shall be mandatorily submitted by BA along with supply of material to TPWODL stores/site:

S. No.	Documents	Requisite
1	Invoice copy in original	With all consignments
2	LR copy	Wherever required
3	Packing list	With all consignments
4	MDCC	With all consignments
5	Purchase order / Release order	Signed copy
6	Test certificates	With all consignments
7	Inspection/JVR report	In case pre-dispatch inspection is conducted
8	Device data in CD as per template for metering items	Wherever applicable

12.5 Dispatch and Delivery Instructions

S. No.	Instructions
1	Purchase order/ Release order no. shall be mentioned on invoice and on material
2	TPWODL material code and material description shall be mentioned in invoice and on material.
3	"Property of TPWODL" shall be embossed on material.
4	The material shall be properly sealed and packed in standard packing as per purchase order terms & conditions.
5	The weight and quantity of material shall be mentioned wherever applicable
6	The material supplied shall be co-related with the packing list.
7	The name plate detail on equipment shall include Material code, Material description, specification detail of material [as applicable], Serial No. Year of manufacturing, PO/RO no. and date, "PROPERTY OF TPWODL, Burla", Guarantee period and Associate's name.
8	In case of manual unloading, supplier / transporter shall deploy sufficient Labour for unloading the material at TPWODL central store. For heavy item(s), crane will be provided by TPWODL [unloading cost will be recovered from the associate].
9	The driver should have valid License and one helper in truck. All the documents of truck like registration papers, PUC etc. should be available in Truck.
10	BA representative should accompany the material and get it unloaded / stacked in his presence wherever possible.

13.0 GUARANTEE

13.1 Guarantee of Performance

Associates shall stand guarantee that the equipment and material supplied under the contract is free from design, manufacturing, material, construction, erection & installation and workmanship & quality defects and is capable of its due, rated and intended quality performance, as an integrated product delivered under the contract, for a specific period termed as Guarantee Period(as elaborated elsewhere in this clause). The Associate should also guarantee that the equipment/material is new and unused except for the usage required for the tests and checks required as part of quality assurance.

13.2 Guarantee Period

The Guarantee Period will be equipment/service/work specific and shall be as specified in the Standard Specifications of TPWODL for the equipment/material/service/work and where standard specifications are not part of contract documents or guarantee period is not specified in the standard specifications,, the guarantee period shall be as per the Special Terms and Conditions of the Contract. In case of no mention of the guarantee period in standard specifications or SCC Guarantee Period will be 12 Months from the Date of Commissioning or 24 months from the date of delivery of final lot of supplies made, whichever is earlier.

13.3 Failure in Guarantee Period (GP)

If the equipment and material supplied under the contract fails to perform its due, rated & intended quality performance, during the Guarantee period, the associate is liable to undertake repair/rectify/replace the equipment and material supplied within time frame specified in the SCC or elsewhere in the contract documents at associate's cost to make the equipment and material supplied/service or work rendered under the contract of performing its due, rated and

Doc. Title	GENERAL CONDITIONS OF CONTRACT FOR SUPPLY ORDERS	
Rev. No	0	Page 15 of 44

intended quality performance. If Associate fails to repair/rectify/replace the equipment or material supplied rendered under the contract, failed in Guarantee Period, TPWODL will be at liberty to get the same done at Associate's risks and costs and recover all such expenses plus the TPWODL's own charges (@ 20% of expenses incurred), from the Associate or from the "Security cum Performance Deposit" as the case may be.

If during the Warranty/ Guarantee period some parts of the supplies are replaced owing to the defects/ damages under the Warranty, the Warranty period for such replaced parts shall be until the expiry of twelve months from the date of such replacement or renewal or until the end of original Guarantee period, whichever is later.

Any repairs during the Guarantee Period shall be carried out by the Associate within 30 days of reporting the issue to Associate by TPWODL. However, if replacement of the Equipment is required, Associate shall notify the same to TPWODL within 7 days of reporting the issue by TPWODL. Thereafter, the total time for supply of new equipment/ material shall be equal to the original delivery period of that equipment/ material as specified in the Contract. In case the Associate is not able to rectify/ replace the faulty equipment/ material within the stipulated timelines as mentioned above, penalty shall be levied as per the Liquidated Damages clause mentioned in this document. The penalty amount shall be recovered from the payment due to the vendor or by encashment of the SPBG as the case may be.

13.4 Cost of repairs on failure in GP

The cost of repairs/rectification/replacement, required transportation, site inspection /mobilization/dismantling and re-installation costs as applicable, to be borne by Associate. The Associate has to ensure that the interruption in the usage of intended purpose of the equipment is minimized to the maximum extent. In lieu of the time taken for repairs/rectification/replacement.

13.5 Guarantee period for Goods Outsourced

If the Associate outsources partly equipment/materials/services from third party as mutually agreed upon at the pre award stage of contract, TPWODL shall have the benefit of any additional guarantee period if provided by the third party for the part supplied/executed by them.

13.6 Latent Defect

Hidden defects in manufacturing or design of the product supplied and which could not be identified by the tests conducted but later manifested during operation of the equipment are termed as latent defects. Associates shall further be responsible for 'free replacement' for another period of THREE years from the end of the guarantee period for any 'Latent Defects' if noticed and reported by the Company.

13.7 Support beyond the Guarantee Period

The Associate shall ensure availability of spares and necessary support for a period of atleast 10 years post completion of guarantee period of equipment supplied against the contract.

14.0 LIQUIDATED DAMAGES

- a) For supplies which are of standalone use, multiple in quantities and having a single final delivery schedule, Liquidated damages shall be levied without prejudice to any of the other contractual rights of TPWODL, as described below:

Doc. Title	GENERAL CONDITIONS OF CONTRACT FOR SUPPLY ORDERS	
Rev. No	0	Page 16 of 44

For delay of each week and part thereof from the delivery schedule specified in the contract, 1% of contract value corresponding to undelivered quantity, provided full quantity is supplied within 130% of the original contract time. If full contractual quantity is not delivered within 130% of contract time for delivery, TPWODL has the right to levy LD on the entire contract value, subject to a maximum of 10% of the total contract value.

- b) For Supplies having phased delivery schedule as per contract terms, standalone use and multiple in quantities, Liquidated damages shall be levied without prejudice to any of the other contractual rights of TPWODL, as described below:

For the purpose of calculating and applying LD, each delivery lot shall be considered separately. For delay of each week and part thereof, from the delivery schedule specified for the lot, 1% of the contract value corresponding to the undelivered quantity of the lot subject to a maximum of 10% of the total contract value of the subject lot. However, if full contractual quantity is not delivered within 130% of contract time for delivery, TPWODL has the right to levy LD on the entire contract value, subject to a maximum of 10% of the total contract value. Deduction of LD shall be on landed cost i.e contract value inclusive of taxes and in pursuant statutory compliance GST would be applicable at the stipulated rate and the same shall be borne by Business Associate. In case of LD deduction, a GST invoice shall be issued by TPWODL as a proof of deduction/ recovery.

14.1 LD Waiver Request

Any request of LD waiver shall be submitted within thirty (30) days of deducting LD. Request submitted beyond the timeline shall not be entertained.

15.0 UNLAWFUL ACTIVITIES

The Associate shall have to ensure that none of its employees are engaged in any unlawful activities (whether covered under the scope of the present GCC or not) subversive of the TPWODL's interest failing which appropriate action (legal or otherwise) may be taken against the Associate by the TPWODL, in accordance with the terms of the present GCC.

16.0 CONFIDENTIALITY

Associate and its employees or representatives thereof shall strictly maintain the confidentiality of various information they come across while executing the contract as detailed below.

16.1 Documents

All maps, plans, drawings, specifications, schemes and other documents or information related to the Contract/Project and the subject matter contained therein and all other information given to the Associate by the TPWODL in connection with the performance of the contract shall be held confidential by the Associate and shall remain the property of the TPWODL and shall not be used or disclosed to third parties by the Associate for any purpose other than for which they have been supplied or prepared. The Associate may disclose to third parties, upon execution of confidentiality agreements, such part of the drawings, specifications or information if such disclosure is necessary for the performance of the Work provided such third parties agree in writing to keep such information confidential to the same extent and degree as provided herein, for the benefit of the TPWODL.

16.2 Geographical Data

Maps, layouts and photographs of the unit/plant including its surrounding regions showing vital installation for national security of country or those of TPWODL shall not be published or

Doc. Title	GENERAL CONDITIONS OF CONTRACT FOR SUPPLY ORDERS	
Rev. No	0	Page 17 of 44

disclosed to the third parties or taken out of the country without prior written approval of the TPWODL and upon execution of confidentiality agreements satisfactory to the TPWODL with such third parties prior to disclosure.

16.3 Associate's Processes

Title to secret processes if any developed by the Associate on an exclusive basis and employed in the design of the equipment shall remain with the Associate. TPWODL shall hold in confidence such processes and shall not disclose such processes to the third parties without prior approval of the Associate and execution by such third parties of secrecy agreements satisfactory to the Associate prior to disclosure. Upon completion of contract, such processes shall become the property of the TPWODL. Title to technical specifications, drawings, flow sheets, norms, calculations, diagrams, interpretations of test results, schematics, layouts and such other information, which the Associate has supplied to the TPWODL under the Contract shall be passed on to the TPWODL. The TPWODL shall have the right to use these for construction, erection, start-up, Trial Run, operation, maintenance, modifications and/or expansion of the works including for the manufacture of spare parts.

16.4 Exclusions

The provision of Clauses 16.1 to 16.3 shall not apply to information:

- Which at the time of disclosure are in the public domain which later on become part of public domain through no fault of the party concerned, or
- Which were in the possession of the party concerned prior to disclosure to him by the other party, or
- Which were received by the party concerned after the time of disclosure without restriction on disclosure or use, from a third party who did not acquire such information directly or indirectly from the other party or has no obligation of confidentiality for such information.

16.5 Violation

In case of violation of this clause, the Associate is liable to pay compensation and damages as may be determined by the competent authority of TPWODL.

17.0 INTELLECTUAL PROPERTY RIGHTS

If, in the course of performance of its functions and duties as envisaged by the scope of the present GCC, the Associate acquires or develops, any unique knowledge or information which would be covered, or, is likely to be covered within the definition of a trademark, copyright, patent, business secret, geographical indication or any other form of intellectual property right, it shall be obliged, under the terms of this present GCC, to share such knowledge or information with the TPWODL. All rights, with respect to, or arising from such intellectual property, as afore mentioned, shall solely vest in TPWODL.

Moreover, the Associate undertakes not to breach any intellectual property right vesting in a third party/parties, whether by breach of statutory provision, passing off, or otherwise. In the event of any such breach, the Associate shall be wholly liable to compensate, indemnify or make good any loss suffered by such third party/parties, or any compensation/damages arising from any legal proceeding/s, or otherwise. No liability of TPWODL shall arise in this respect, and any costs, damages, expenses, compensation payable by TPWODL in this regard to a third party/parties, arising from a legal proceeding/s or otherwise, shall be recoverable from the Associate.

Doc. Title	GENERAL CONDITIONS OF CONTRACT FOR SUPPLY ORDERS	
Rev. No	0	Page 18 of 44

18.0 INDEMNITY

The Associate shall at all times indemnify, keep indemnified and hold harmless the TPWODL and its officers, directors, employees, affiliates, agents, successors and assigns against all actions, claims, demands, costs, charges and expenses arising from or incurred by reason of any infringement of patent, trade mark, registered design, copy rights and/or industrial property rights by manufacture, sale or use of the equipment supplied by the Associate whether or not the TPWODL is held liable for by any court judgement. In this connection, the TPWODL shall pass on all claims made against him to the Associate for settlement.

The Associate assumes responsibility for and shall indemnify and save harmless the TPWODL from all liability, claims, costs, expenses, taxes and assessments including penalties, punitive damages, attorney's fees and court costs which are or may be required to be paid by the TPWODL and its officers, directors, employees, affiliates, agents, successors and assigns arising from any breach of the Associate's obligations under the Contract or for which the Associate has assumed responsibilities under the Contract including those imposed under any local or national law or laws, or in respect to all salaries, wages or other compensation for all persons employed by the Associate or his Sub-Associates or suppliers in connection with the performance of any work covered by the Contract. The Associate shall execute, deliver and shall cause his Sub-Associate and suppliers to execute and deliver, such other further instruments and to comply with all the requirements of such laws and regulation as may be necessary there under to conform and effectuate the Contract and to protect the TPWODL.

The TPWODL shall not be held responsible for any accident or damages incurred or claims arising, due to the Associate's error there from prior to completion of work. The Associate shall be liable for such accidents and after completion of work for such accidents as the case may be due to negligence on his part to carry out Work in accordance with Indian laws and regulations and the specifications set forth herein.

19.0 LIABILITY & LIMITATIONS

19.1 Liability

Except for any specific liability which may be identified in the Contract and which may be payable hereunder, Associate shall not be liable for any special, incidental, indirect, or consequential Damages or any loss of business Contracts, revenues or other financial loss (or equivalents thereof no matter how claimed, computed or characterized) arising out of or in connection with the Performance of the Work or supply of Goods ***unless caused by Associate's negligence, willful misconduct or breach of contract.***

If the Associate is a joint venture or consortium, all concerned parties shall be jointly and severally bound to the TPWODL for the fulfillment of the provisions of the Contract. The consortium or the joint venture shall designate one party as their leader, who will be the coordinator between the parties and TPWODL. The constituents & leader of the consortium or joint venture shall not be changed without the prior consent of TPWODL.

TPWODL shall have no liability or any special, incidental, indirect or consequential Damages for any loss of Business Contracts, revenues or other financial loss arising out of this Contract.

19.2 Limitation of Liability

The total liability of Associate against any contract shall be limited to the Total All Inclusive Contract Value.

Doc. Title	GENERAL CONDITIONS OF CONTRACT FOR SUPPLY ORDERS	
Rev. No	0	Page 19 of 44

20.0 FORCE MAJEURE

Force Majeure applies if the performance by either Party ("the Affected Party") of its obligations under Contract is materially and adversely affected.

"Force Majeure" shall mean any event or circumstance or combination of events or circumstances referred below and their consequences that wholly or partly prevents or unavoidably delays any Party in the performance of its obligations under this Agreement, but only and to the extent that such events and circumstances are not within the reasonable control, directly or indirectly, of the Affected Party and could not have been avoided even if the Affected Party had taken reasonable care:

- Act of war (whether declared or undeclared), invasion, armed conflict or act of foreign enemy, embargo, blockade, revolution, riot, bombs, religious strife or civil commotion, etc. ▪ Politically motivated sabotage, or terrorism, etc.
- Action or Act of Government or Governmental agency for which remedy is beyond the control of the affected parties. ▪ Any act of God.

Note: Causes like power breakdown/ shortages/fire/strikes, accidents etc do not fall under Force Majeure.

Time being the essence of the Contract, if either party is prevented from the performance of its obligations in whole or in part due to an event of Force Majeure, then provided Notice of happening of any event by the Affected Party is given to the other party within seven (7) days from the date of occurrence of such event, which DIRECTLY has impact on works and submitted details and quantum of resulting effect, but at the same time had made all possible efforts to mitigate and overcome effects thereof, the Affected Party's performance under this Contract shall be suspended until such event ceases and the Scheduled Completion shall be delayed accordingly.

If Force Majeure event(s) continue for a period of more than three months, the parties shall hold consultation to discuss the further course of action.

Neither party shall be considered to be in default or in breach of its obligation under the Contract to the extent that performance of such obligation by either party is prevented by any circumstances of Force Majeure which arise after effective date of Contract.

Neither party can claim any compensation from the other party on account of Force Majeure.

21.0 SUSPENSION OF CONTRACT

21.1 Suspension for Convenience

TPWODL may, at any time and at its sole option, suspend execution of all or any portions of the schedule of items of contract to be supplied/work to be executed by Associate under the contract by providing to the Associate at least two business days written notice for contracts having contract completion period less than sixty days and at least seven business days' notice for all other contracts.

Upon receipt of any such notice, the Associate shall respond as follows as applicable as per contract construction.

- Immediately discontinue further supply of material/goods specified in the suspension notice for supply contracts

Doc. Title	GENERAL CONDITIONS OF CONTRACT FOR SUPPLY ORDERS	
Rev. No	0	Page 20 of 44

- Immediately discontinue further service/work and supply of materials of those services/materials/work specified in the suspension notice for service /composite contract
- Promptly make every reasonable effort to obtain suspension, upon terms satisfactory to TPWODL, of all orders, outsourcing arrangements, and rental Contracts to the extent that they relate to performance of the portion of Work suspended by the notice.
- Protect and maintain the portion of the service/Work already completed, including the portion of the Work suspended hereunder, unless otherwise specifically stated in the notice.
- Continue delivering/carrying out the supply/service/work items as per contract conditions, which do not fall under purview of the suspension notice.

On receipt of resumption notice from TPWODL, the Associate shall resume execution of contract as specified in the resumption notice, within the time frame specified in the resumption notice.

21.2 Suspension for Breach of Contract conditions.

TPWODL shall suspend execution of whole/or part thereof the contract till such time Associate complies with the conditions stipulated under section clause 22.1 for breach/default of contract conditions.

21.3 Compensation in lieu of Suspension

If the suspension of the contract in whole or in part is for convenience of TPWODL and not due to any breach of contract conditions by the associate, TPWODL at its discretion shall consider compensating all reasonable additional costs incurred by Associate in lieu of suspension of whole or part of contract, on representation of the Associate providing justified estimates of such additional costs and such estimates are found acceptable and approved by competent authority of TPWODL.

If the suspension of contract in whole or part thereof is due to breach of contract conditions (refer clause 22.1) by the Associate, Associate shall not be entitled for any compensation for any cost incurred in lieu of suspension of whole or part of contract and also shall be liable for compensating all the losses arising to TPWODL in lieu of suspension of contract. Resumption notice shall be subject to the Associate taking corrective action for the breach of contract conditions within the time frame and as per the terms specified in the suspension notice.

22 TERMINATION OF CONTRACT

22.1 Termination for Default/Breach of Contract

The contract / PO /RC shall be subject to termination by TPWODL in case of breach of the contract by the Associate which shall include but not be limited to the following:

- a. Withdrawal or intimation by the Associate of its intent to withdraw or surrender the execution / completion of the contracted work /PO or failure in ensuring adherence to any delivery schedules, in deviation of the contract/PO.
- b. Refusal or neglect on the part of the Associate to supply material/equipment of quantity or quality as specified by TPWODL and within the timeframe as specified in the contract document or refusal or neglect to execute the services/work in terms of the agreed standards of quantity or quality and/or within the timeframe specified in the contract/PO.

Doc. Title	GENERAL CONDITIONS OF CONTRACT FOR SUPPLY ORDERS	
Rev. No	0	Page 21 of 44

- c. Failure in any respect to perform any portion of the Work contracted with promptness, diligence, or in accordance with the terms of the contract.
- d. Failure to furnish guarantees as specified and /or failure to comply with the terms thereof.
- e. Failure to furnish such relevant documents or information within the time specified which may be necessary for due execution / completion of the works and documentation.
- f. Liquidation, bankruptcy either voluntary or involuntary OR entering into any composition or compromise with its creditors, or Insolvency.
- g. In case any reasonable information has been received by TPWODL that Associate has adopted/ or attempted to adopt any unethical conduct, action in award of the contract /PO or at any time thereafter.
- h. Failure to comply with applicable statutory provisions as contained in the contract or failure to comply with the applicable laws.
- i. Failure to comply with safety regulations/clauses stipulated in the contract or as may be generally instructed by TPWODL.

If the default or breach as specified under clause 22 (except sub clause g thereof) be committed by the associate for the first time, TPWODL shall issue, along with notice of default or breach, a warning notice instructing the associate to take remedial/corrective action within the time frame stipulated in the warning notice and not to repeat the same in future. The timeframe for corrective action by the associate shall be specific to the nature of breach of contract and the same shall not be objected to by the Associate. If the Associate fails to comply with the instructions in the warning notice or in taking corrective action to the satisfaction of TPWODL then TPWODL may terminate the entire or part of contract at its discretion by issuing termination notice without incurring any liability on this ground.

In case the contract is terminated for any breach of the nature specified in clause 22 g stated above, TPWODL shall have the right to terminate all the contracts TPWODL is having with the Associate by issuing termination notice which shall be without prejudice to the other rights of TPWODL available to it under law.

Without prejudice to its right to terminate for breach of contract, TPWODL may, without assigning any reason, terminate the Contract in whole or in part at any time at its discretion while the contract is in force by serving a written notice of two weeks to the Associate.

In the event of TPWODL having proceeded with termination of the contract the associate shall comply and proceed further in the following manner:

- a) Associate shall discontinue the supply, on the expiry of the said period of two weeks.
- b) Associate shall ensure that no further steps are being taken towards discharge of the obligations, terms and conditions as contained in the contract/PO. This shall include initiation of actions not limited to discontinuation of other allied and associated arrangements which the associate might have entered into with third parties for due discharge of its obligations under the contract with TPWODL.
- c) The Associate shall perform thereafter such tasks as may be necessary to preserve and protect the terminated portion of the material/service/work in progress and the materials and equipment at TPWODL sites or in transit thereto. However the associate shall continue to fulfill its contractual obligations with regard to the part of contract not terminated.

Doc. Title	GENERAL CONDITIONS OF CONTRACT FOR SUPPLY ORDERS	
Rev. No	0	Page 22 of 44

- d) It shall be open for TPWODL to conduct a joint assessment with the associate of the material, supplies, equipment ,works or in general as to the subject matter of the contract in regard to which the associate claims having completed its obligations before or during such termination.
- e) It shall be open to TPWODL to seek invocation of the performance bank guarantee or any other guarantee or other security deposit by whatever name called submitted by the associate, which shall not be objected to or protested against by the associate.

In case of termination of the contract the parties agree to be governed inter alia by the following:

- a) In case TPWODL exercises its right of termination as stated above the associate shall not dispute or object to the same.
- b) The Associate shall be entitled to receive and claim only such payments OR sums of money from TPWODL as may be found payable to it in regard to works executed by it under the terms of the contract and no other claim of any nature whatsoever shall be made by the Associate.
- c) All such provisions which the parties have agreed to survive and prevail even after termination of the contract shall remain effective despite the termination.

In the event of such termination, TPWODL may finish the Work by whatever method it may deem expedient, including the hiring of services and /or purchase of material equipment from such third parties as TPWODL may deem fit or may itself provide any labor or materials and perform any part of the Work. The associate undertakes to bear the incremental costs if any paid by TPWODL in such a case attributable to failure on the part of the associate. The Associate in such a case shall not be entitled to receive any further payments and any sums found payable to it may be adjusted by TPWODL against the amount recoverable from him on this ground. The same shall be without prejudice to other rights available to TPWODL under law against the associate.

Upon the termination of any of the contract due to occurrence of any circumstances provided in clauses stated above and constituting repeated breach or misconduct , TPWODL shall be entitled to bar the associates its agents , affiliates from undertaking any negotiation / tendering, bidding , participation activities concerning TPWODL for a period of two years from date of such termination. The same shall be without prejudice to other rights available to TPWODL.

22.2 Termination for Convenience of Associate

Associate at its convenience may request for termination of contract, clearly assigning the reason for such request. TPWODL has full right to accept, reject or partially accept such request. However, associate shall continue its supply as per contract till final approval is given to associates for such termination.

22.3 Termination for Convenience of TPWODL

TPWODL at its sole discretion may terminate the contract by giving 30 days prior notice in writing or through email to the Associate. TPWODL shall pay the Associate for all the supplies/ services rendered till the actual date of contract termination against submission of invoice by the Associate to that effect.

Doc. Title	GENERAL CONDITIONS OF CONTRACT FOR SUPPLY ORDERS	
Rev. No	0	Page 23 of 44

23.0 DISPUTE RESOLUTION & ARBITRATION

In case of any dispute or difference the parties shall endeavor to resolve the same through conciliatory and amicable measures within 15 Days failing which the matter may be referred by either party for resolution by the sole arbitrator to be appointed mutually by both the parties. The arbitral proceedings shall be conducted in accordance with Arbitration and Conciliation Act 1996 and the place of arbitration shall be Sambalpur. The language to be used at proceedings shall be English and the award of the arbitrator shall be final and binding on the parties. The parties shall bear their respective costs of arbitration. The associate shall continue to discharge its obligations towards due performance of the works as per the terms of the contract during the arbitration proceedings unless otherwise directed in writing by TPWODL or suspended by the arbitrator. Further, TPWODL shall continue making such payments as may be found due and payable to the associate for such works.

23.1 Governing Laws and Jurisdiction

The parties shall be subject to the jurisdiction of the courts of law in Sambalpur and any matter arising here from shall be subject to applicable law in force in India.

24.0 ATTRIBUTES OF GCC

24.1 Cancellation

The Company reserves the right to cancel, add, delete at its sole discretion, all or any terms of this GCC or any contract, order or terms agreed between the parties in pursuance without assigning any reasons and without any compensation to the Associates.

24.2 Severability

If any portion of this GCC is held to be void, invalid, or otherwise unenforceable, in whole or part, the remaining portions of this GCC shall remain in effect.

24.3 Order of Priority

In case of any discrepancies between the stipulations in General Conditions of the Contract (GCC) and Special Conditions of Contract (SCC), the GCC shall stand superseded by the SCC to the extent stipulated hereinabove while balance portion of respective clauses of GCC shall continue to be applicable.

25.0 ERRORS AND OMISSIONS

The Associate shall be responsible for all discrepancies, errors and omissions in the drawings, documents or other information submitted by him, irrespective of whether these have been approved, reviewed or otherwise accepted by the TPWODL or not. However any error in design/drawing arising out of any incorrect data/written information from TPWODL will not be considered as error and omissions on part of the Associate.

26.0 TRANSFER OF TITLES

The title of ownership and property to all equipment, materials, drawings & documents shall pass to the TPWODL on acceptance of material by store/site after Inspection.

However, such passing of title of ownership and property to the TPWODL shall not in any way absolve, dilute or diminish the responsibility and obligations of the Associate under this Contract including loss or damages and all risks, which shall vest with the Associate.

Doc. Title	GENERAL CONDITIONS OF CONTRACT FOR SUPPLY ORDERS	
Rev. No	0	Page 24 of 44

27.0 INSURANCE

The Contractor shall take out the Insurance Policies which shall cover all risks including the following, as applicable:-

- a) The value of the policy shall cover the total value of all the items till they are handed over to TPWODL.
- b) TPWODL shall be the principal holder of the policy. The Associate shall be the loss payee under the policy. Associate / Sub-contractor of the Associate shall not be holders or beneficiaries in the policy nor shall they be named in the policy. TPWODL reserves the exclusive right to assign the policy.
- c) While the payment of premium may be phased in agreement with the insurance company, at no time shall goods and services required to be provided by the associate shall remain uninsured in accordance with (a) above.
- d) A copy of the Insurance policy shall be made available to TPWODL prior to first dispatch lot of any Equipment and policy shall be kept alive and valid at all times up to the stage of final acceptance.
- e) TPWODL reserves the right to take out whatever policy that is deemed necessary by him if the associate fails to keep the said policy alive and valid at all times and/or causes lapses in payment of premium thereby jeopardizing the said policy. The cost of such policy(s) shall be recovered / deducted from the amount payable to the associate.
- f) The policy shall ensure that the TPWODL's decision regarding replacement of goods damaged, lost or rendered unusable shall be final.

In all cases, the associate shall lodge the claims with the underwriters and also settle the claims and shall also notify TPWODL of any filed claims. However, the associate shall proceed with the repairs and/or replacement of the equipment/components without waiting for the settlement of the claims. In case of seizure of materials by concerned authorities, the associate shall arrange prompt release against bond, security or cash as required. TPWODL, upon request by the associate, will extend all reasonable assistance to the associate in such a case.

All the insurance claims shall be processed and settled by the associate and the missing/damaged items shall be replaced/repared by them without any extra cost to TPWODL and without affecting the completion time.

28.0 SUGGESTIONS & FEEDBACK

We welcome all our Business Associates to write to us about their experience with TPWODL; be it our Company, our services or our people. Each and every concern, issue, query and suggestion from you will help us to become a better company to work with and shall help us develop a strong bonding of trust and a long term relationship with you.

You may send your feedback by filling up our Business Associate Feedback Form enclosed herewith as *Annexure-I*. You can also log on to our website www.tatapower.com to provide your feedback.

- Suggestions for us
- Feedback form
- Knowledge Sharing/ Experience with TPWODL

Doc. Title	GENERAL CONDITIONS OF CONTRACT FOR SUPPLY ORDERS	
Rev. No	0	Page 25 of 44

- Any issues with TPWODL.

Submission of feedback form is mandatory before the release of final payment to the BA.

29.0 CONTACT POINTS

In case Business Associate needs information with respect to payments or has any grievances, same may be lodged by log on to our website www.tatapower.com

30.0 LIST OF ANNEXURES

S. No.	Subject	Annexure
1.	Performa for Bid Security Bank Guarantee	A
2.	Performa for Performance Bank Guarantee (CP cum EP)	B
3.	Performa for No Demand Certificate by Associate	C
4.	Performa For Application For Issuance of Consolidated TDS Certificate	D
5.	Business Associate Feedback Form	E
6.	Acceptance Form For Participation In Reverse Auction Event	F
7.	Form for RTGS Payment	G
8.	Vendor Appraisal Form	H
9.	Manufacturer Authorization Form	I

Doc. Title	GENERAL CONDITIONS OF CONTRACT FOR SUPPLY ORDERS	
Rev. No	0	Page 26 of 44

ANNEXURE-A

PROFORMA FOR BID SECURITY BANK GUARANTEE

**TP Western Odisha Distribution Ltd
Burla**

WHEREAS, (Name of the Bidder) _____
(hereinafter called "the BIDDER") has submitted his bid dated _____ for the
(Name of Contract) _____ (hereinafter called "the BID").

KNOW ALL men by these presents we (Name of the
Bank) _____ of (Name of the
Country) _____ having our registered
office at _____ (hereinafter called "the BANK) are bound unto The
TP Western Odisha Distribution Ltd (TPWODL) in the sum of _____ for
which payment well and truly to be made to the TPWODL the Bank binds himself, his
successors and assigns by these presents.

SEALED with the Common Seal of the said Bank this _____ day of _____ 20_____.

The CONDITIONS of this obligation are:

- i) If the Bidder withdraws his Bid during the period of bid validity specified in the Proforma of Bid or
- ii) If the Bidder having been notified of the acceptance of his Bid by the TPWODL during the period of bid validity fails or refuses to furnish the Contract Performance Bank Guarantee, in accordance with the Instructions to Bidders.

We undertake to pay the TPWODL upto the above amount upon receipt of its first written demand, provided that in its demand the TPWODL will note that amount claimed by it is due to it owing to the occurrence of one or both conditions, specifying the occurred condition or conditions.

Doc. Title	GENERAL CONDITIONS OF CONTRACT FOR SUPPLY ORDERS	
Rev. No	0	Page 27 of 44

This Guarantee will remain in force upto and including the date (No of days as mentioned in tender enquiry) days after the closing date of submission of bids as stated in the Invitation to Bid or as extended by you at any time prior to this date, notice of which extension to the Bank being hereby waived, and any demand in respect thereof should reach the Bank not later than the above date.

DATE **SIGNATURE OF THE BANK**

WITNESS **SEAL**

(Signature, Name & Address) (At least 2 witnesses)

ANNEXURE- B

PROFORMA FOR PERFORMANCE BANK GUARANTEE (CP cum EP)

(On Rs.100/- Stamp Paper) Note:

- a) Format shall be followed in toto
- b) Claim period of one month must be kept up
- c) The guarantee to be accompanied by the covering letter from the bank confirming the signature to the guarantee

TP Western Odisha Distribution Ltd

Burla

CP cum EP BG No.....

Order/Contract No.....dated.....

1. You have entered into a Contract No _____ with M/s. _____ (hereinafter referred to as "the Vendor") for the supply cum erection / civil work of _____ (hereinafter referred to as "the said Equipment") for the price and on the terms and conditions contained in the said contract.
2. In accordance with the terms of the said contract, "the Vendor" agreed to furnish you with an irrevocable, unconditional and acceptable bank guarantee for 10% of the value of contract and to be valid till the end of Guarantee period plus one month towards "Contract cum Equipment performance". For this purpose you have agreed to accept the guarantee.
3. In consideration thereof, we, _____ hereby irrevocably and unconditionally guarantee to pay to you on demand but in any case before the end of five working days from the date of the claim and without demur and without reference to "the Vendor" such amount or amounts not exceeding the sum of Rs. _____ (Rupees _____ only) being _____% (_____ percent) of the total value of the contract on receipt of your intimating that "the

Doc. Title	GENERAL CONDITIONS OF CONTRACT FOR SUPPLY ORDERS	
Rev. No	0	Page 28 of 44

Vendor” has not fulfilled his contractual obligations. You shall be the sole judge for such non-fulfillment and “the Vendor” shall have no right to question such judgment.

4. You shall have the right to file / make your claim on us under the guarantee for a **further period of one month** from the date of expiry.
5. This guarantee shall not be revoked without express consent and shall not be affected by your granting time or any other indulgence to “the Vendor”, which shall include but not be limited to, postponement from time to time of the exercise the same in you or any right which you may have against “the Vendor” and to exercise the same in any covenant contained or implied in the said contract or any other course or remedy or security available to you, and our Bank shall not be released from its obligations under this guarantee by

GENERAL CONDITIONS OF CONTRACT

Doc. Title	GENERAL CONDITIONS OF CONTRACT FOR SUPPLY ORDERS	
Rev. No	0	Page 29 of 44

your exercising any of your rights with reference to matters aforesaid or any of them or by reasons of any other act or forbearance or other acts of omission or commission on your part or any other indulgence shown by you or by any other matter or thing whatsoever which under the law would, but for this provision have the effect of relieving our bank from its obligation under this guarantee.

6. We also agree that you shall be entitled at your option to enforce this guarantee against our bank as a principal debtor, in the first instance, notwithstanding any other security or guarantee that you may have in relation to "the Vendor's" liabilities in respect of the premises
7. This guarantee shall not be affected by any change in the constitution of our Bank or "the Vendor" or for any other reason whatsoever.
8. Any claim / extension under the guarantee can be lodge-able at outstation banks or at Sambalpur branch and claim will also be payable at Sambalpur Branch (to be confirmed by Sambalpur Branch by a letter to that effect in case BG is from the branch outside Sambalpur).
9. Notwithstanding anything herein contained, our liability under this guarantee is limited to Rs. _____ (Rupees _____) only and the guarantee will remain in force upto and including _____ (Date) and shall be extended from time to time for such period or period as may be desired by "the Vendor".
10. Unless a demand or claim under this guarantee is received by us in writing within one months from _____ (expiry date) i.e. on or before _____ (claim period end date), we shall be discharged from all liabilities under this guarantee thereafter.

Dated at _____ this _____ day of _____ 20__

Bank's rubber stamp

1. Banks full address

Designation of Signatory

2. Bank official number

Doc. Title	GENERAL CONDITIONS OF CONTRACT FOR SUPPLY ORDERS	
Rev. No	0	Page 30 of 44

ANNEXURE-C

PROFORMA FOR “NO DEMAND CERTIFICATE” BY ASSOCIATE

(On Company's Letter head or with Company Seal)

(To be submitted by the Associate to TPWODL Accounts Department at the time of receipt of full and final payment)

(Certificate No. CCP/002)

Name of the Project Order/

Contract No.

Dated

Name of the Associate Scheme

No. / Job No.

We, M/s. _____ (Associate) do hereby acknowledge and confirm that we have received the full and final payment due and payable to us from TPWODL, in respect of our aforesaid Order No _____ dated _____ including amendments, if any, issued by TPWODL to our entire satisfaction and we further confirm that we have no claim whatsoever pending with TPWODL under the said contract / W.O.

Notwithstanding any protest recorded by us in any correspondence, documents, measurement books and / or final bills etc., we waive all our rights to lodge any claim or protest in future under this contract.

We are issuing this “NO DEMAND CERTIFICATE” in favour of TPWODL, with full knowledge and with our free consent without any undue influence, misrepresentation, coercion etc.

Place

Name

(Company Seal)

Doc. Title	GENERAL CONDITIONS OF CONTRACT FOR SUPPLY ORDERS	
Rev. No	0	Page 31 of 44

ANNEXURE-D

**PROFORMA FOR APPLICATION FOR ISSUANCE OF CONSOLIDATED TDS
CERTIFICATE**

To be printed on the letterhead

To,

The TP Western Odisha Distribution Ltd,

Burla

Sub: Application for issuance of Consolidated TDS Certificate for the FY _____

Dear Sir,

I / we hereby request / authorize you to issue me / us a consolidate TDS Certificate for the financial year _____ against tax deducted at source by you from my / our payments / bills during the said year from time to time under Chapter XVII – B of the Income Tax Act, 1961. For and on behalf of

Signature

Name

Address

Contact No. (Land Line)

(Mobile)

PAN #

Assessing authority

ATTACH THE COPY OF PAN CARD

Doc. Title	GENERAL CONDITIONS OF CONTRACT FOR SUPPLY ORDERS	
Rev. No	0	Page 32 of 44

ANNEXURE-E

BUSINESS ASSOCIATE FEEDBACK FORM

With an objective to improve our internal processes and systems, and serve you better, we solicit your valuable feedback & suggestions. It is estimated that it will take about 10 minutes to complete this survey. We assure you that your feedback shall be kept confidential. Please send the duly filled feedback form in the "TPWODL addressed - attached envelop"

You are associated with us as

- OEMs Service Contractor Material Suppliers Material & Manpower Supplier

You are associated with us for

- Less than 1 year More than 1 year but less than 3 years More than 3 years

Your office is located at

- Sambalpur Within 200 kms from Sambalpur More than 200 kms from Sambalpur

Your nearly turnover with TPWODL

- Less than 25 Lacs 25 Lacs to 1 Crore More than 1 Cr.

Additional Information

Your Name	
Your Designation	
Your Organization	
Contact Nos.	
Email	

We once again thank you for your participation in this survey. Please spare 10 minutes to give your feedback on following pages (Section A to E)

Doc. Title	GENERAL CONDITIONS OF CONTRACT FOR SUPPLY ORDERS	
Rev. No	0	Page 33 of 44

SECTION – A

(Please ✓ mark in the relevant box and give your remarks / suggestions / information for our improvement).

S. No.	Parameters	1	2	3	4	5	Remarks/ Suggestion
		Do Not Agree	Slightly in Agreement	In Fair Agreement	Mostly in Agreement	Fully Agree	
1	You receive all relevant queries / tenders from us in timely manner.						
2	We provide you enough lead time to respond to our queries / tenders.						
3	We provide you adequate support (drawings, documents, clarifications, briefing etc.) to enable you meet our requirements.						
4	All following elements of our contract / purchase order are rational :						
4.1	Scope of Work						
4.2	Delivery / Execution Schedule						
4.3	Payment Terms						
4.4	Liquidated Damages						
4.5	Performance Guarantee						
5	Our purchase orders / contracts are simple, specific & easy to understand						
6	TPWODL demonstrate willingness to be flexible in administration of Contract / Purchase Order						
7	We provide timely responses / clarifications to your queries						
8	TPWODL representative you interact / coordinate with is adequately empowered to support you in meeting contractual obligations						
9	TPWODL provide you all necessary infrastructure support for timely and quality completion of work (including AMC)						
10	TPWODL Engineer-in-Charge timely certifies the jobs executed/ material supplied						
11	TPWODL Engineer-in-Charge efficiently supervises the job execution for timely completion of job						
12	BIRD (Bill Inward Receipt Desk) initiative has improved payment disbursement process						

Doc. Title	GENERAL CONDITIONS OF CONTRACT FOR SUPPLY ORDERS	
Rev. No	0	Page 34 of 44

S. No.	Parameters	1	2	3	4	5	Remarks/ Suggestion
		Do Not Agree	Slightly in Agreement	In Fair Agreement	Mostly in Agreement	Fully Agree	
13	Our approach for Inspection and Quality Assurance effective to expedite project completion?						
14	TPWODL never defaults on contractual terms						
15	In TPWODL Contracts closure is done within set time limit						
16	Our material receiving procedures are well defined and efficiently deployed to reduce mutual inconvenience						
17	Bank Guarantees are released in time bound manner						
18	Our processes related to payment / account settlement are effective.						
19	You get payments on time						
20	TPWODL Employees follow Ethical behaviour						

GENERAL CONDITIONS OF CONTRACT

Doc. Title	GENERAL CONDITIONS OF CONTRACT FOR SUPPLY ORDERS		
Rev. No	0	Page 35 of 44	

SECTION – B

SECTION – B (Please rate the following parameters on a scale of 1 to 5, where 1 - Minimum; 5 - Maximum)

S. No.	Parameters	1	2	3	4	5	Remarks/ Suggestion
1	How do you rate courtesy/ empathy/ attitude level and warmth of TPWODL employees you interact with from following team?						
1.1	Project Engineering						
1.2	District / Zones						
1.3	Projects/HOG (TS &P)						
1.4	Inspection & Quality Assurance						
1.5	Stores						
1.6	Metering & Billing						
1.7	Accounts / Finance						
1.8	Administration						
1.9	IT & Automation						
2	How would you rate TPWODL in comparison to your other clients in terms of fairness of treatment and transparency with its Business Associates?						
3	How would you rate TPWODL in comparison to your other clients in terms of processes and systems to manage partnership with its Business Associates						
4	How would you rate TPWODL in comparison to your other clients in terms of building long term & mutually relationship with its Business Associates						

SECTION – C

Please ✓ mark in the relevant box and give your remarks / suggestions / information for our improvement.

S. No.	Parameters	Certainly No	Probably No	Certainly Yes	Probably Yes	Remarks/ Suggestion
1	Based on your experience with TPWODL, would you like to continue your relationship with TPWODL?					
2	If someone asks you about TPWODL, would you talk "positively" about					

Doc. Title	GENERAL CONDITIONS OF CONTRACT FOR SUPPLY ORDERS	
Rev. No	0	Page 36 of 44

	TPWODL?					
3	Would you refer TPWODL name to others in your community, fraternity and society as a professional & dynamic organization?					

SECTION - D

If we ask you to rate us on a scale of 1 to 10, how will you rate TPWODL, that truly represents your overall satisfaction with us (please tick appropriate box) -

1	2	3	4	5	6	7	8	9	10
---	---	---	---	---	---	---	---	---	----

SECTION - E

Please ✓ mark in the relevant box and give your remarks / suggestions / information for our improvement.

Please spare your thoughts for TPWODL's improvement in particular areas of weaknesses, particularly relating to some great practices, attitudes that you have seen elsewhere in Indian and International Organizations, which you recommend TPWODL to adopt. Please give your valuable salient recommendations.

Please spare your thoughts for TPWODL's improvement in particular areas of major concerns for you. We also welcome your suggestions to adopt any best practices, attitudes that you

Recommendation	<i>Please tick (✓) your top 5 expectations out of the following 10 points listed below -</i>	
(Please list down improvement you expect from TPWODL)	<i>Timely payment</i>	
1	<i>Flexibility in Contracts/PO</i>	
	<i>Clarity in PO,s & Contracts</i>	
2	<i>Timely response to quarries</i>	
	<i>Timely certification of works executed</i>	
3	<i>Clarity in Specs, drawings, other docs etc.</i>	
	<i>Adequate information provided on website for tender notification, parties qualified etc.</i>	
4	<i>Timely receipt of material at site for execution</i>	

Doc. Title	GENERAL CONDITIONS OF CONTRACT FOR SUPPLY ORDERS	
Rev. No	0	Page 37 of 44

	<i>Performance Guarantee/EMD released in time</i>	
5	<i>Inspection & quality assurance support for timely job completion</i>	

We thank you for your time and courtesy!!

ANNEXURE-F

ACCEPTANCE FORM FOR PARTICIPATION IN REVERSE AUCTION EVENT

(To be signed and stamped by the bidder prior to participation in the auction event)

In a bid to make our entire procurement process more fair and transparent, TPWODL intends to use the reverse auctions through SAP-SRM tool as an integral part of the entire tendering process. All the bidders who are found as technically qualified based on the tender requirements shall be eligible to participate in the reverse auction event.

The following terms and conditions are deemed as accepted by the bidder on participation in the bid event:

1. TPWODL shall provide the user id and password to the authorized representative of the bidder. (Authorization Letter in lieu of the same shall be submitted along with the signed and stamped Acceptance Form).
2. TPWODL will make every effort to make the bid process transparent. However, the award decision by TPWODL would be final and binding on the supplier.
3. The bidder agrees to non-disclosure of trade information regarding the purchase, identity of TPWODL, bid process, bid technology, bid documentation and bid details.
4. The bidder is advised to understand the auto bid process to safeguard themselves against any possibility of non-participation in the auction event.
5. In case of bidding through Internet medium, bidders are further advised to ensure availability of the entire infrastructure as required at their end to participate in the auction event. Inability to bid due to telephone line glitch, internet response issues, software or hardware hangs, power failure or any other reason shall not be the responsibility of TPWODL.
6. In case of intranet medium, TPWODL shall provide the infrastructure to bidders. Further, TPWODL has sole discretion to extend or restart the auction event in case of any glitches in infrastructure observed which has restricted the bidders to submit the bids to ensure fair & transparent competitive bidding. In case an auction event is restarted, the best bid as already available in the system shall become the start price for the new auction.
7. In case the bidder fails to participate in the auction event due any reason whatsoever, it shall be presumed that the bidder has no further discounts to offer and the initial bid as submitted by the bidder as a part of the tender shall be considered as the bidder's final no regret offer. Any offline price bids received from a bidder in lieu of non-participation in the auction event shall be out rightly rejected by TPWODL.
8. The bidder shall be prepared with competitive price quotes on the day of the bidding event.
9. The prices as quoted by the bidder during the auction event shall be inclusive of all the applicable taxes, duties and levies and shall be FOR at TPWODL site.
10. The prices submitted by a bidder during the auction event shall be binding on the bidder.
11. No requests for time extension of the auction event shall be considered by TPWODL.
12. The original price bids of the bidders shall be reduced on pro-rata basis against each line item based on the final all inclusive prices offered during conclusion of the auction event for arriving at Contract amount.

Signature & Seal of the Bidder

Doc. Title	GENERAL CONDITIONS OF CONTRACT FOR SUPPLY ORDERS	
Rev. No	16	Page 39 of 44

Name of the Authorized Signatory: _____ :

Contact Person's Name:

Official Correspondence Address:

We confirm that we will bear the charges, if any, levied by our bank for the credit of NEFT/RTGS amounts in our account. Any change in above furnished information shall be informed to TPWODL well in time at our own. Further, we kept TPWODL indemnified for any loss incurred due to wrong furnishing of above information.

Thanking you,

For _____

(Authorised Signatory)

(Signature with Rubber Stamp)

Certification from Bank:

We confirm that we are enabled for receiving NEFT/RTGS credits and we further confirm that the account number (specify Bank a/c no.) of (Please mention here name of the account holder), the signature of the authorised signatory and the MICR and IFSC Code of our branch mentioned above are correct.

This also is certified that the above information is correct as per Bank record

(Manager's/ Officers Signature under Bank Stamp)

Doc. Title	GENERAL CONDITIONS OF CONTRACT FOR SUPPLY ORDERS	
Rev. No	16	Page 40 of 44

ANNEXURE-H
VENDOR APPRAISAL FORM

TO BE SUBMITTED BY VENDOR (To be filled as applicable)			
VENDOR:			
1.0	DETAILS OF THE FIRM		
	1.1	NAME (IN CAPITAL LETTERS)	:
	1.2	TYPE OF CONCERN (PROPRIETARY) Partnership, Pvt. Ltd., Public Ltd. etc.	:
	1.3	YEAR OF ESTABLISHMENT	:
	1.4	LOCATION OF OFFICE POSTAL ADDRESS TELEGRAPHIC ADDRESSES, TELEX NO. FAX NO.	:
	1.5	LOCATION OF MANUFACTURING UNITS	:
		i) UNITS 1	:
		ii) OTHER UNITS	:
2.0	PRODUCTS MANUFACTURED		
3.0	TURNOVER DURING THE LAST 3 YEARS (TO BE VERIFIED WITH THE LATEST PROFIT & LOSS STATEMENT).		
4.0	VALUE OF FIXED ASSETS		
5.0	NAME & ADDRESS OF THE BANKERS		
6.0	BANK GUARANTEE LIMIT		
7.0	CREDIT LIMIT		
8.0	TECHNICAL		
	8.1	NO. OF DESIGN ENGINEERS (INDICATE NO. OF YEARS EXPERIENCE IN RELATED FIELDS)	:
	8.2	NO. OF DRAUGHTS MEN	:
	8.3	COLLABORATION DETAILS (IF ANY)	:
		8.3.1 DATE OF COLLABORATION	:
		8.3.2 NAME OF COLLABORATOR	:
		8.3.3 RBI APPROVAL DETAILS	:
		8.3.4 EXPERIENCE LIST OF COLLABORATOR	:
		8.3.5 DURATION OF AGREEMENT	:
	8.4	AVAILABILITY OF STANDARDS / DESIGN PROCEDURES / COLLABORATOR'S /	:

Doc. Title	GENERAL CONDITIONS OF CONTRACT FOR SUPPLY ORDERS	
Rev. No	16	Page 41 of 44

		DOCUMENTS (CHECK WHETHER THESE ARE LATEST/CURRENT)	
	8.5	TECHNICAL SUPPORT, BACK-UP GUARANTEE, SUPERVISION, QUALITY CONTROL BY COLLABORATOR (WHEREVER ESSENTIAL). (THIS CLAUSE IS RELEVANT WHEN VENDOR'S EXPERIENCE IS INADEQUATE)	:
	8.6	QUALITY OF DRAWINGS	:
9.0	MANUFACTURE		
	9.1	SHOP SPACE, LAYOUT LIGHTING, VENTILATION, ETC.	:
	9.2	POWER (KVA)	:
		MAINS INSTALLED	:
		UTILIZED	:
		STANDBY POWER SOURCE	:
	9.3	MANUFACTURING FACILITIES (ATTACH LIST OF EQUIPMENT AS APPLICABLE)	:
		9.3.1 MATERIAL HANDLING	:
		9.3.2 MACHINING	:
		9.3.3 FABRICATION	:
		9.3.4 HEAT TREATMENT	:
		9.3.5 BALANCING FACILITY	:
		9.3.6 SURFACE TREATMENT PRIOR TO PAINTING/ COATING, POLISHING, PICKLING, PASSIVATION, PAINTING, ETC.	:
	9.4	SUPERVISORY STAFF	:
	9.5	ADEQUACY OF SKILLED LABOURS (MACHINISTS, WELDERS, ETC.)	:
	9.6	NO. OF SHIFTS	:
	9.7	TYPE OF MATERIAL HANDLED (SUCH AS CS, SS, ETC.)	:
	9.8	WORKMANSHIP	:
	9.9	MATERIAL IN STOCK AND VALUE	:
	9.10	TRANSPORT FACILITIES	:
	9.11	CARE IN HANDLING	:
10.0	INSPECTION / QC / QA / TESTING		
	10.1	NUMBER OF PERSONNEL (INDICATE NO. OF YEARS OF EXPERIENCE)	:
	10.2	INDEPENDENCE FROM PRODUCTION	:

Doc. Title	GENERAL CONDITIONS OF CONTRACT FOR SUPPLY ORDERS	
Rev. No	16	Page 42 of 44

	10.3	AVAILABILITY OF PROCEDURAL WRITE UP/QUALITY PLAN	:
	10.4	INCOMING MATERIAL CONTROL AND DOCUMENTATION	:
	10.5	RELIABILITY/REPUTATION OF SUPPLY SOURCES	:
	10.6	STAGE INSPECTION AND DOCUMENTATION	:
	10.7	SUB-ASSEMBLY & DOCUMENTATION	:
	10.8	FINAL INSPECTION AND DOCUMENTATION	:
	10.9	PREPARATION OF FINAL DOCUMENTATION PACKAGE	:
	10.10	TYPE TEST FACILITIES	:
	10.11	ACCEPTANCE TEST FACILITIES	:
	10.12	CALIBRATION OF INSTRUMENTS AND GAUGES (WITH TRACEABILITY TO NATIONAL STANDARDS) (ATTACH LIST)	:
	10.13	STATUTORY APPROVALS LIKE BIS, IBR, ETC.(AS APPLICABLE)	:
	10.14	SUB-VENDOR APPROVAL SYSTEM AND QUALITY CONTROL	:
	10.15	DETAILS OF TESTS CARRIED OUT AT INDEPENDENT RECOGNIZED LABORATORIES	:
		i) FURNISH LIST OF TESTS CARRIED OUT AND THE NAME OF THE LABORATORY WHERE THE TESTS WERE CONDUCTED	:
		ii) CHECK AVAILABILITY OF CERTIFICATES AND REVIEW THESE WHEREVER POSSIBLE	:
	11.0	EXPERIENCE (INCLUDING CONSTRUCTION / ERECTION / COMMISSIONING) TO BE FURNISHED IN THE FORMAT INDICATED IN APPENDIX)	:
	12.0	SALES, SERVICE AND SITE ORGANIZATIONAL DETAILS	:
	13.0	CERTIFICATE FROM CUSTOMERS (ATTACH COPIES OF DOCUMENTS)	:
	14.0	POWER SITUATION	:
	15.0	LABOUR SITUATION	:
	16.0 *	APPLICABILITY OF SC/ST RELAXATION (Y/N) IF YES, SUPPORTING DOCUMENTS TO BE ATTACHED	
	17.0	ORGANIZATIONAL DETAILS 1. PF NO 2. ESI NO 3. INSURANCE FOR WORK MAN COMPENSATION ACT NO 4. ELECTRICAL CONTRACT LIC NO 5. ITCC / PAN NO 6. SALES TAX NO 7. WC TAX REG. NO	:
	18.0	DOCUMENTS TO BE ENCLOSED:	

Doc. Title	GENERAL CONDITIONS OF CONTRACT FOR SUPPLY ORDERS	
Rev. No	16	Page 43 of 44

	<ol style="list-style-type: none"> 1. FACTORY LICENSE 2. ANNUAL REPORT FOR LAST THREE YEARS 3. TYPE TEST REPORT FOR THE ITEM 4. PAST EXPERIENCE REPORTS 5. ISO CERTIFICATE –QMS, EMS, OHAS, SA 6. REGISTRATION OF SALES TAX 7. COPY OF TIN NO. 8. COPY OF SERVICE TAX NO. 9. REGISTRATION OF CENTRAL EXCISE 10. COPY OF INCOME TAX CLEARANCE. 11. COPY OF PF REGISTRATION 12. COPY OF ESI REGISTRATION 13. COPY OF INSURANCE FOR WORK MAN COMPENSATION ACT NO 14. COPY OF ELECTRICAL CONTRACT LIC NO 15. COPY OF PAN NO 16. COPY OF WC TAX REGISTRATION 17. DOCUMENTS IN SUPPORT OF SC/ST RELAXATION AT S.NO.16.0 18. GSTN CERTIFICATE 	
--	--	--

* **Classification of BA s under SC/ST shall be governed under following guidelines:**

- **Proprietorship/ Single Ownership Firm:** Proprietor of the firm should be from SC/ST community. Governing document shall be Proprietorship Deed.
- **Partnership Firm:** Only such firms shall qualify which have SC/ST partners holding equal to or more than 50% of the total ownership pattern of the firm. Governing document shall be Partnership Deed.
- **Private Limited Company:** Only such firms shall qualify which have SC/ST directors holding equal to or more than 50% of the total ownership pattern of the firm. Governing document shall be Memorandum of Understanding (MoU) and/or Article of Association (AoA).

NOTE: Certification from SC/ST Commission shall be required for deciding upon SC/ST status of a person.

Doc. Title	GENERAL CONDITIONS OF CONTRACT FOR SUPPLY ORDERS	
Rev. No	16	Page 44 of 44

ANNEXURE-I

MANUFACTURER AUTHORIZATION FORM

(To be submitted on OEM's Letter Head)

Date:

Tender Enquiry No.:

To,
Chief (Procurement & Stores)
The TP Western Odisha Distribution Ltd,
Burla

Sir,

WHEREAS M/s. [name of OEM], who are official manufacturers of having factories at [address of OEM] do hereby authorize M/s [name of bidder] to submit a Bid in relation to the Invitation for Bids indicated above, the purpose of which is to provide the following Goods, manufactured by us

.....and to subsequently negotiate and sign the Contract.

We hereby extend our full guarantee and warranty in accordance with the Special Conditions of Contract or as mentioned elsewhere in the Tender Document, with respect to the Goods offered by the above firm in reply to this Invitation for Bids.

We hereby confirm that in case, the channel partner fails to provide the necessary services as per the Tender Document referred above, M/s [name of OEM] shall provide standard warranty on the materials supplied against the contract. The warranty period and inclusion / exclusion of parts in the warranty shall remain same as defined in the contract issued to their channel partner against this tender enquiry.

Yours Sincerely,

For

Authorized Signatory

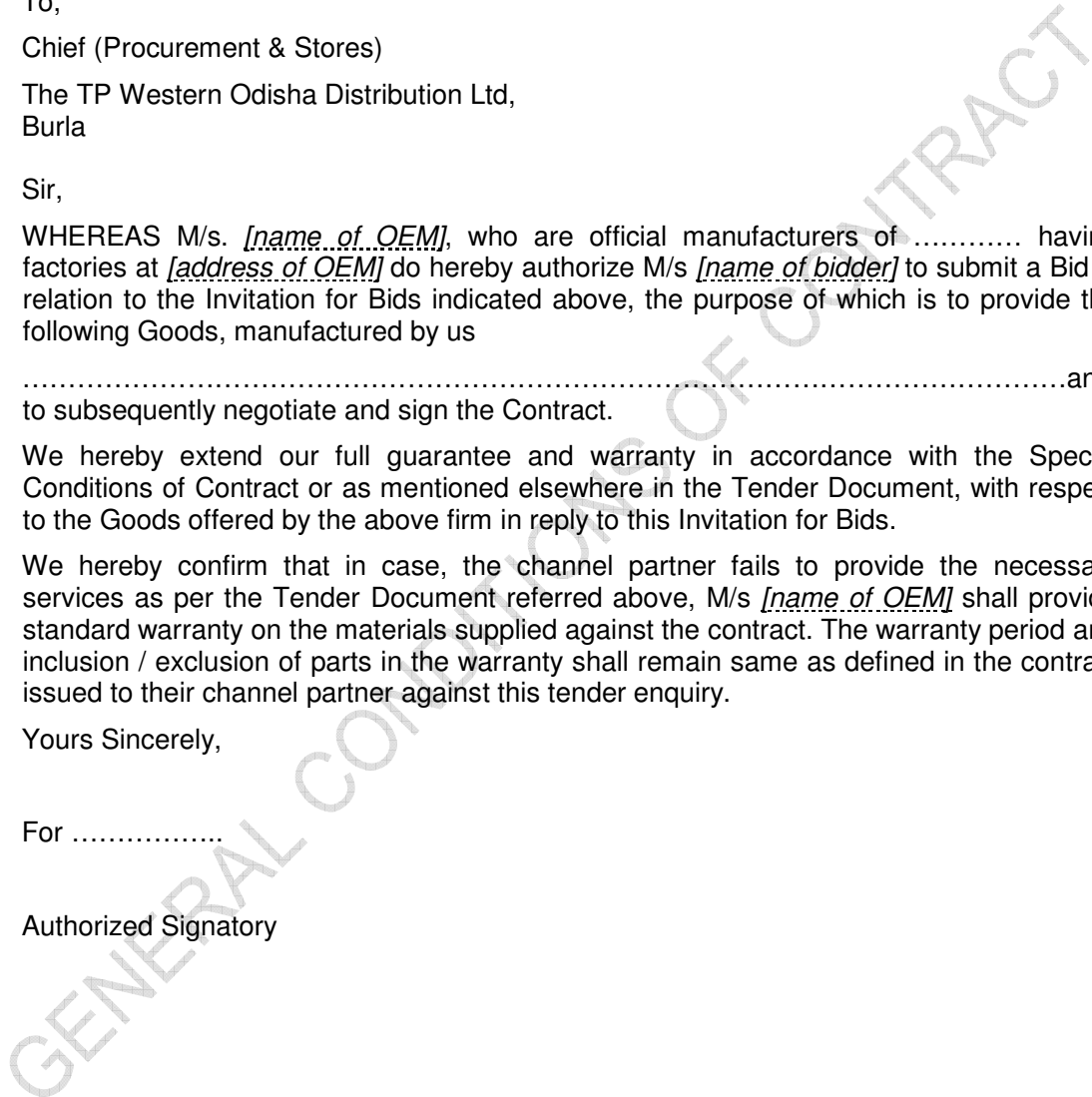

Annexure VIII

Safety Policy and Safety Terms and Conditions

The Tata Power Company Ltd



Contractor's Safety Code of Conduct

*Document No.
TPSMS/GSP/CSM/015 REV 05*

*Date of Issue:
30/07/2020*

Contractor's Safety Code of Conduct

Reason for Change	Prepared By	Checked By	Approved by
Revision to accommodate Existing changes in org structure and to simplify the procedure	Rajesh Sharma <i>(Head-Safety Generation)</i>	Suresh Khetwani <i>(Chief - Safety & Environment)</i> Monish Kumar <i>(Chief -Corporate Contract)</i>	V. V. Namjoshi <i>(Chief Generations)</i>

INDEX

1. Objective 3

2. ScopeError! Bookmark not defined.

3. Definitions 3

3.1. Order Manager: 3

3.2. Site Safety Management Plan 3

3.3. Contractor 3

3.4. Emergency: 3

3.5. Expert Service jobs: 3

3.6. Head of the Division: 4

3.7. Category A Vendor: Vendor 4

3.8. Category B Vendor: 4

3.9. Category C Vendor: 4

3.10. Category D Vendor: 4

3.11. High Risk Jobs 4

3.12. Medium Risk Jobs: 4

3.13. Low Risk Jobs: 4

3.14. Long Duration Jobs: 4

3.15. High Value Jobs: 4

4. Responsibilities 5

4.1 Order Manager 5

4.2 Contractor 5

4.3 Safety Concurrence Group 5

5. Procedure:Error! Bookmark not defined.

Appendix 1: Process Flow Chart for Vendor Registration 7

Appendix 2: CSM-F-1 Safety Category Qualification form 8

Appendix 3: Safety Terms and Conditions 9

Appendix 4: CSM- F-3- Safety Performance Evaluation Criteria 10

Appendix 5: CSM- F-4 Safety Violation Penalty Criteria 12

Appendix 6: Process Flow Chart for issuing RFQ and PO 16

Appendix 7: CSM-F-7 Safety Competency Form (Template) 17

Appendix 8: CSM-F-8 PPE requirements 19

Appendix 9: CSM- F-10 Site Safety Management Plan / Method Statement 20

Appendix 10: Process Flow Chart for Safety Performance Evaluation 25

Appendix 11: CSM- F-11 Safety Performance Score 26

Appendix 12: CSM-F-5 Safety Potential Evaluation Criteria for Vendor Registration 28

Appendix 13: CSM-F-9 Safety Bid Evaluation Criteria 31

Appendix 14: CSM-F-11.1 CFSA Format 34

Appendix 15: Indicative List of High-Risk Jobs 35

1. Objective

The Tata Power engages contractor workforce to execute, run and maintain various operating sites and facilities across locations for various business verticals including Generation, Transmission, Distribution and Renewable. The activities range from project execution, operation, maintenance to facilities management.

The management of contractor safety represents a significant challenge for management. Tata Power has a responsibility to ensure that contractors are provided with enough information and support to enable them to conduct their roles safely and without endangering health and safety of their own workforce or that of our staff.

To ensure reduction in reportable injuries and achieve goal of zero accidents, first edition of contractor safety code of conduct was launched successfully in the year 2014. Since last four years after the launch of CSCC, Tata Power could achieve the objective of reduction in reportable injuries and fatalities.

Over the period, as the system was being matured, a need was felt to make second revision of the CSCC process. Objective of second revision is improve existing CSCC system and make it user friendly.

2. Scope: This procedure applies to all operating and project sites of The Tata Power Company Ltd and Group companies including new businesses like EV charging, Home Automation etc.

3. Definitions

- 3.1. Order Manager:** Order Manager is the Tata Power representative, who has the ownership of the given job.
- 3.2. Site Safety Management Plan:** It is the safety plan agreed between Contractor and Tata Power. It will contain the entire job specific safety requirement and will be signed by the contractor.
- 3.3. Contractor:** An individual or a company that provides services to Tata Power under a signed contract.
- 3.4. Emergency:** a serious, unexpected or dangerous situation requiring immediate action, which may result in loss of revenue/property, business discontinuity. In case of Emergency*, services may be procured by selecting the qualified vendor based on the vendor category without the safety bid evaluation. It must be approved by MB level and above.
- 3.5. Expert Service jobs:** Jobs which needs expert services of contractor which does not involve direct exposure to the potential risk or work which involves only

supervisory work such as expert for turbine overhaul, expert for boiler overhaul, expert for pump and motor, expert for compressor overhaul.

- 3.6. Head of the Division:** Business in charge of the division who is overall custodian of the generating station or transmission division or distribution division.
- 3.7. Category A Vendor:** Vendor eligible to carry out Very High & High risk (as per Tata Power Hazard Identification and Risk Analysis Procedure) and /or Long-Term Contract related to operation and maintenance (O&M) of plant. Vendors must fulfil the requirement specified for Category A in Appendix 12-CSMF-5 of this document.
- 3.8. Category B Vendor:** Vendors eligible to carry out technical jobs, that are classified under Medium /low risk. Vendors must fulfil the requirement specified for Category B in Appendix 12-CSMF-5 of this document.
- 3.9. Category C Vendor:** Vendors eligible for to carry out low or very low risk administrative and office jobs. For this he must fulfil the requirement specified for Category C in Appendix 12-CSMF-5 of this document.
- 3.10. Category D Vendor:** All Consultants, Medical Practitioners or vendors taking job from Tata Power and working from their own premises (e.g. motor rewinding at vendor's shop floor, equipment sent for repair to vendor's works etc.) are classified as Category D Vendor
- 3.11. High Risk Jobs:** A Job or its activities are considered as Very High or High Risk when Order manager apply the "Tata Power Hazard Identification and Risk Analysis" procedure and found safety risk associated with are under Very High or High category. Indicative lists of jobs are given in appendix 15 of this document.
- 3.12. Medium Risk Jobs:** Jobs or its activities are considered as medium risk when Order manager apply "Tata Power Hazard Identification and Risk Analysis" procedure and found the same as Medium Risk.
- 3.13. Low Risk Jobs:** Any job or its activities are considered as Low or Very low risk while Order manager, calculate it by applying "Tata Power Hazard Identification and Risk Analysis" procedure and found it under Low or Very Low category.
- 3.14. Long Duration Jobs:** When the duration of job is 12 months or more, it is considered as Long duration job
- 3.15. High Value Jobs:** When the value of the job contract is Rs. One Crore or more it will be considered as High value job.

4. Responsibilities

4.1 Order Manager: Order Manager is the Tata Power representative, who is responsible for:

- 4.1.1 Finalizing the Site Safety Management Plan along with Contractor, Safety Concurrences Group, Divisional Safety Head and Expert (External or Internal) if required.
- 4.1.2 Supervise and ensure work is carried out as per the Site Safety Management Plan including agreed Risk Assessment (HIRA/JSA) and Method Statement.
- 4.1.3 Conduct audit and evaluate Safety Performance of contractor.
- 4.1.4 Ensure contractors adhere to all statutory provisions.
- 4.1.5 In case any deviation is needed in agreed safety management plan or in CSCC process for execution of job, Management of Change procedure will be applicable, and approval may be obtained from divisional head /Cluster head.

4.2 Contractor: The person, entity or organisation who is executing the job for Tata Power under a contractual agreement and will be responsible for the following

- 4.2.1 To follow all Tata Power Critical Safety Procedure, Rules and guidelines given in Safety Terms and Conditions
- 4.2.2 Undertake job as per Site Safety Management Plan CSM-F10 and method statements agreed with Tata Power.
- 4.2.3 Raise any concerns with regard to their work and its safety with the Tata Power Order Manager.
- 4.2.4 Report all injuries, near misses, unsafe acts/conditions, and occurrences to the Tata Power Order Manager immediately.
- 4.2.5 Ensure that all sub-contractors follow the Tata Power Safety Procedure and agreed Site Safety Management Plan CSM-F10.
- 4.2.6 To follow all statutory requirements as per the laws of the land.
- 4.2.7 All vendors applying for A category jobs or submitting quote for high risk jobs shall obtain certificates of ISO 9001, ISO14001 and ISO45001 before submitting quote for high risk Jobs.

4.3 Safety Concurrence Group: It is Cross Functional Team constituted by Corporate Safety Team, which will have representatives from Execution department, Divisional safety and Corporate / Divisional contracts. SCG will be responsible for the following

- 4.3.1 Assessment of Safety Potential of new vendor before registration as per CSM-F1-Safety Category Qualification Form.
- 4.3.2 Safety Evaluation of the bids as per evaluation format CSM-F-9 Safety Bid Evaluation Criteria
- 4.3.3 Finalization of the Site Safety Management Plan CSM-F-10 submitted by the contractor.

- 4.3.4 Corporate Safety Team / Cluster Safety Head will be part of SCG during Safety Bid Evaluation for following types of jobs
- 4.3.4.1 High-Risk jobs to be carried out in Annual Overhaul / Major Shutdowns and Outages.
 - 4.3.4.2 Capex jobs of High-Risk Category

5.1 Vendor Registration

For Vendor Registration, Corporate Contract will issue following documents for evaluation of contractor's safety capability

- 1) CSM-F1 –Safety Category Qualification Form
- 2) Safety Terms and Conditions

The document Safety Terms and Conditions provides the information about Tata Power safety System to the contractor. Contractor will submit the CSM-F1- Safety Category Qualification Form with all relevant details and documents to Vendor Registration Initiator, which will in turn forward it to Safety Concurrence Group (SCG) for evaluation. The SCG will evaluate the details submitted by the contractor based on a predetermined criteria CSM-F-5 Safety Potential Evaluation Criteria for Vendor Registration and will determine the category (Category A/B/C/D) for which the contractor will be registered. As mentioned in the above criteria, a site visit may also be organized by SCG prior to registration under Category A and B. In case, the contractor does not qualify the safety criteria, the contractor will not be registered. However, he may apply afresh for registration after 6 months. Please refer Appendix 1: Process Flow Chart for Vendor Registration.

5.2 Bid evaluation

At the time of placing the Purchase Requisition (PR), Order Manager is required to declare the risk involved in the of the job (i.e. High Risk / Medium Risk / Low Risk jobs, based on the RPN in HIRA. If the Job is "High Risk" or "Long Duration", then RFQ will be attached with following documents:

- 1) CSM-F7- Blank Safety Competency Form
- 2) CSM-F8 PPE requirements
- 3) Safety Terms and Conditions
- 4) Job Specific Safety Requirement (Educational and Professional Qualification, Skill & Experience Manpower, Tools and Tackles (e.g. man lifter, use of drone, use & availability of rescue kit), Work Methodology etc.)

Otherwise the RFQ will be attached only with Safety Terms and Conditions. Long term and low value jobs (see definition) are exempted from the CSCC process.

Corporate Contracts will collect duly filled CSM-F7 Safety Competency Form along with the bid. All other stakeholders will also put their efforts to get all relevant safety data during meeting / discussions with the vendor. SCG will evaluate the document as per the CSM-F9 Safety bid evaluation criteria. If any specific condition related to Contract is required to convey to contractor, Site safety team will attach the same as Annexure for specific conditions of job and submit it to contract team along with safety bid evaluation form. Commercial bid of contractor will be considered for evaluation by contract team only if contractor is qualified in safety bid. Site Safety Management Plan, defining the complete procedure of executing the job at site will be signed by the contractor and SCG after mutual agreement. CC will attach a copy of site safety Management Plan and any specific condition of contract along with PO to the successful bidder. Please refer Appendix 6: Process Flow Chart for issuing RFQ and PO significant health and safety risk associated with it.

5.3 Safety Performance Evaluation

During the time of job execution, regular site inspection will be carried out by the Tata Power officials and violations will be dealt as per CSM-F4 Safety Violation Penalty Criteria. Apart from this, monthly safety performance of the contractor will be evaluated based on the predetermined criteria as per CSM-F11 safety Performance Score and monthly score will be maintained by the Order Manager. Certain percentage of each running bill will be retained as Safety Retention amount and will be released on the basis of Safety Performance Score at certain intervals as defined in CSM- F-3- Safety Performance Evaluation Criteria. Please refer Appendix 10: Process Flow Chart for Safety Performance Evaluation. Percentage of retention amount is mentioned in safety terms and conditions.

Appendix 1: Process Flow Chart for Vendor Registration

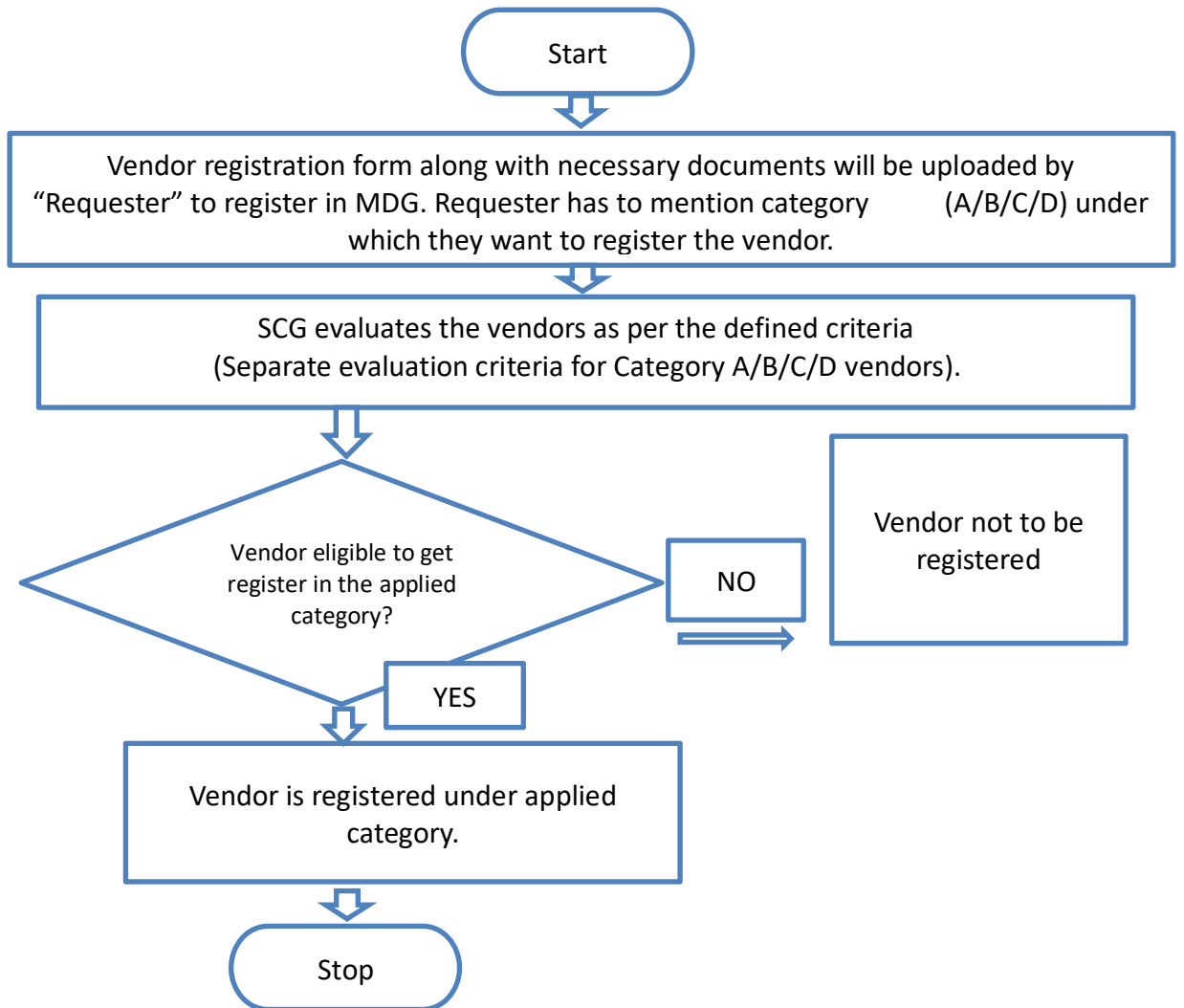

Appendix 2: CSM-F-1 Safety Category Qualification form

1. **“Safety Category Qualification Form”** is part of vendor registration form. It needs to be filled by the contractor at the time of Registration and should be submitted to Requester / order manager with all relevant documents.
2. The same will be evaluated by Safety Concurrence Group of the Division (SCG) as per the criteria given in CSM-F-5.
3. Information provided by contractor will be verified during site visit.

Safety Category Qualification Form

Please Consider my application for

Category A Vendor: Vendor eligible to carry out Very High- and High-risk O&M jobs

Category B Vendor: Vendors eligible to carry out technical jobs, classified as Medium / low risk

Category C Vendor: Vendors eligible for to carry out low or very low risk administrative and office jobs

Category D vendor: All Consultants, Medical Practitioners or vendors taking job from Tata Power and working from their own premises.

Name of the Vendor:					
Sr. No	Safety Information	Remarks	Attachment		
1	Certified for i. OHSAS 18001/ ISO 45001, ii. ISO: 14001 iii. ISO: 9001 (ISO certificates to be issued from reputed accreditation agencies specified by Tata Power)	i. Y/ N ii. Y/ N iii. Y/ N	Attach copy of the certification		
2	Safety Statistics for Last Three (3) Years - LTIFR - LTISR	Yes/No	Year 1 (Last FY)	Year 2	Year 3
			LTIFR		
			LTISR		
3	Do you have Safety Policy?	Yes/No	Attach copy of the safety policy.		
4	Do you have Safety training process?	Yes/No	Attach safety training process.		
5	Do you have Safety organization structure e.g. Safety Officers and Safety Committees?	Yes/No	Attach copy of the safety organization structure.		
6	Name and address of sites where work is in progress or worked earlier	Yes/No	Site details to be attached for inspection by Officials.		

Signature _____ :

Name and Designation _____ :

Stamp of Organization _____ :

Appendix 3: Safety Terms and Conditions

Please refer the attached document Safety Terms and Conditions.

Appendix 4: CSM- F-3- Safety Performance Evaluation Criteria

1. A certain percentage of the bill value will be retained against every running bill as safety performance retention. The amount will be released with the last invoice or every six-month based on Safety Performance Score of contractors. The retention amount will be calculated based on contract value as below.

Contract Value	Retention Amount (%)
Up to 10 Lakhs	2.5
10 – 50 lakhs	2
0.5 to 10 Cr	1.5
>10 Cr	1

2. The evaluation criteria include Lead Indicators such as CFSA (Contractor Field safety Audit) score, percentage of workers trained in TPSDI, inspection of critical equipment. Lag indicators such as Fatalities, LWDC and man days lost.

3. The retention amount saved will go to a separate Safety Improvement Fund.

4. For the contract value of more than Rs 1 Cr or contract duration more than 12 months, the retention amount shall be released half yearly based on safety performance. For all remaining contracts, the retention amount will be released with the final bill.

5. Long term jobs with low value (Less than Rs. 1 Cr.) are exempted from the safety retention. Invoice of these type of jobs can be cleared without safety retention.

6. In case of job stoppage due to safety violations / unsafe observations at the site, no time extension shall be given to the contractor, if such delays are attributable to contractor.

7. In case of fatality, limb loss or loss of property, vendor must pay for liability, legal, statutory and additional mutually agreed settlement charges imposed by the appointed committee. This charge is over and above the retention amount.

8. The committee will finalize an amount between 5 -50 lakhs based on factors such as advise by statutory authorities, contract value and impact of accident etc.

9. Safety performance bonus 1% (limiting to 50 lakhs) of the invoice value will be considered at the end of the job if the contractual safety performance score 100%.

10. During the progress of the work, concerned Supervisor/Engineer will visit and inspect the work site regularly and evaluate the safety performance of the contractor based on matrix attached herewith and apply the Consequence management policy as applicable.

11. Order Manager, divisional chief and SBU head have the authority to terminate the contract in case of three consecutive serious violations.

Safety Performance Evaluation report- CSM-F-3

	<u>Lead Indicators</u>	<u>Unit Of measurement</u>	<u>Target</u>	<u>weight age</u>
1	% of Employee certified in TPSDI/Authorized agency	%	50%	10
2	CFSA score (Annexure 6.1)	Average Severity of Violations	1.49	20
3	Monthly inspection completed by contractor for Critical Equipment, lifting Tools & Tackles and hand tools used at site as per Tata Power Checklist	%	80	5
4	Revalidation of Condition of tools, tackles and equipment by Order Manger.	%	100	15
	<u>Lag Indicators</u>			
1	Number of Fatalities	No.	0	30
2	Number of Lost workday case (LWDC)	No.	0	10
3	Man-days Lost	No.	0	10

Appendix 5: CSM- F-4 Safety Violation Penalty Criteria

Penalty shall be imposed on the contractors under the following circumstances for breaching the contractual agreements:

Sr No	Description of violation	Severity	Penalty
1.	Working without Permit	5	5000/-
2.	Untrained (TPSDI) worker on high-risk jobs.	5	5000/-
3.	Unhygienic/Bad condition of PPE	2	250/-
4.	Not following Tata Power Procedure & Standard	4	2000/-
5.	Unsafe Act/Condition of Severity 4	4	2000/-
6.	Unsafe Act/Condition of Severity 5	5	5000/-
7.	No Earthling of Electrical equipment	5	5000/-
8.	Damaged welding cable	5	5000/
9.	Violation of Positive Isolation Procedure (LOTO Not followed)	5	5000/
10.	ELCB of more than 30 mA/ELCB not working	5	5000/
11.	On/Off switch of welding m/c not working	5	5000/
12.	Electric cable tied with metal wire	5	5000/
13.	Leakage found DA hose / cylinder	5	5000/
14.	Use of LPG	5	5000/
15.	Use of IC engine based Three-wheeler at the work site.	5	5000/
16.	Starting the job without Toolbox Talk	5	5000/
17.	Spatter falling on DA hose / Gas-line/ pathways / Equipment	5	5000/
18.	No safety latch in crane hook	5	5000/
19.	Load raised or swung over people or occupied areas of buildings	5	5000/
20.	Persons standing in swing area of construction equipment.	5	5000/
21.	Using damaged slings.	5	5000/
22.	Unstable scaffolding/nonstandard Scaffolding in use	5	5000/
23.	Handrails and mid-rails are missing	5	5000/
24.	Safety Harness not anchored with lifeline/fixed structure	5	5000/
25.	Fall arrestor not provided/ Not being used.	5	5000/
26.	Double lifeline not used for working at height	5	5000/
27.	No rubber mat in Electrical Distribution (DB) room	4	2000/-
28.	Water found accumulated in Electrical Distribution room/near welding machine.	4	2000/
29.	Inserting electric cables into socket, without using plug.	4	2000/
30.	Use of damaged electrical cable/two core cables.	4	2000/
31.	Inflammable material found in Distribution Room / welding areas.	4	2000/
32.	Loose material falling into excavated pit	4	2000/
33.	Water logging into excavated pit /trenches	4	2000/

34.	No / inadequate Barricade	4	2000/
35.	Undercut / cave-in found on sides of excavated pits	4	2000/
36.	Grinding wheel/ Coupling/ Piling winch/other rotating parts without guard	4	2000/
37.	The HMV/Mobile Crane operator does not have a valid HMV driving license.	4	2000/
38.	The loading area is not leveled properly.	4	2000/
39.	Ladder not anchored at top	4	2000/
40.	Opening found in working platform of scaffolding/floor	4	2000/
41.	Inadequate illumination at the working area	4	2000/
42.	Loose material lying on Gantry, platform	4	2000/
43.	Cleaning with Compressed Air.	3	500/-
44.	Gas Cylinders using without cap.	3	500/
45.	Gas Cylinders stored without securing	3	500/
46.	Bringing inside any other chemicals, apart from approved by Safety dept.	3	500/
47.	Using drum for sitting or accessing height.	3	500/
48.	Misusing emergency facilities like fire hydrant line/ hose box/ spray system/ eye wash etc.	3	500/
49.	No provision of Safety net where falling materials or tools may occurs	3	500/
50.	Taking electrical supply from non-designated outlet (other than socket).	3	500/
51.	Restricted gangways due to unwanted materials.	3	500/
52.	Not reporting incident.	3	500/
53.	Entering into restricted area like switch yard/ hazardous storage	3	500/
54.	Work without supervision	3	500/
55.	Parking of vehicle without applying wheel choke at right front-front and left rear-rear wheels other than passenger cars.	3	500/
56.	Heavy Vehicle without helper or co-driver.	3	500/
57.	Not wearing florescent safety jacket at site.	3	500/
58.	People travelling in load body of vehicle.	3	500/
59.	Parking of vehicles at non designated area.	3	500/
60.	Shifting heavy materials without guide ropes.	3	500/
61.	Using other than 24V lamp inside the confined space/Use of other than 24V lamps.	3	500/
62.	Angular loading/ lifting with Crane or hoist.	3	500/
63.	By passing the limit switch/ Safety Interlock.	3	500/
64.	Housekeeping activities on road without proper barricade.	3	500/
65.	Trying to board or alit from running vehicle.	3	500/
66.	Cylinder Valves of Gas cylinders not closed when not in use.	3	500/
67.	Flash-back arrester not used.	3	500/

68.	Hand Trolley wheel found damaged.	3	500/
69.	Guy ropes of required length on both sides of object are not used during movement with load.	3	5/ 00/
70.	Scotch block/wedge not provided, when the vehicle is parked.	3	500/
71.	Suitable Trolley not provided to hold the cylinders.	3	500/
72.	Locked First Aid box	3	500/
73.	Caution boards, danger signs (luminescent /red) along with emergency contact number are not found displayed.	3	500/
74.	Person found jumping barricading tape	3	500/
75.	Stacking of pipes, pile casing, drums without chock blocks/wedges	3	500/
76.	The terrain on which Heavy Equipment/Machinery moves is not reasonably hard.	3	500/
77.	Without Safety Helmet at working sites	4	250/-
78.	Without Crash Helmet (on bikes)	4	500/-
79.	Without Full body double lanyard Safety Harness (for work at height)	5	5000/-
80.	Without Hand gloves - Material Handling, Welding, Cutting,	4	100/-
81.	Without Safety goggles/ face shield - Welding/Cutting /Grinding	5	5000/-
82.	Handling Chemical without PVC Apron	5	5000/-
83.	Smoking in prohibited area (Closed Go-downs, Storage of flammable material, Storage of Gas cylinders)	5	1000/-
84.	Sleeping at Workplace	3	100/-
85.	Driving beyond speed limit	3	1000/-
86.	Seat Belt While Driving (for front seat passengers and driver)	3	500/-
87.	Driving without license	4	1000/-
88.	Heavy Commercial vehicles without reverse horn	3	500/-
89.	Nonfunctional Head light/ taillight and side indicators	3	100/-
90.	Using Mobile Phone During Driving	5	5000/-
91.	Poor visibility of registration number/ without registration number	3	100/-
92.	Broken/ without Side view mirror	3	100/-
93.	Over speeding above specified limit	3	500/-
94.	Broken/ Without Pressure gauge on Oxygen/ LPG / Acetylene cylinder.	3	500/-
95.	Without Flash back arrestor on Industrial Acetylene & Oxygen cylinders.	5	5000/-
96.	Spillage of hazardous material/chemicals during transportation	4	2000/-
97.	Electrical equipment without Earthing/ ELCB/ Double Insulation Cable.	5	5000/-

98.	Lifting Tools & Tackles used without/ expired Test Certificates.	5	5000/-
99.	Housekeeping repeatedly not maintained		
100.	<ul style="list-style-type: none"> • First Time 	3	Warning
101.	<ul style="list-style-type: none"> • Second Time 	4	1000/-
102.	<ul style="list-style-type: none"> • Third Time 	5	5000/-
103.	Serious Violation of House Keeping (after 1st or 2nd warning to be decided by Project Manager depending on the severity)	5	Rs.10000/- and above
104.	Repeat Violation of same nature	5	5 X Penalty for Violation
105.	Appointment of subcontractor without his Safety Bid Evaluation and/or without the permission of engineer in charge or Order manager.	5	5% of Contract Value

Appendix 6: Process Flow Chart for issuing RFQ and PO

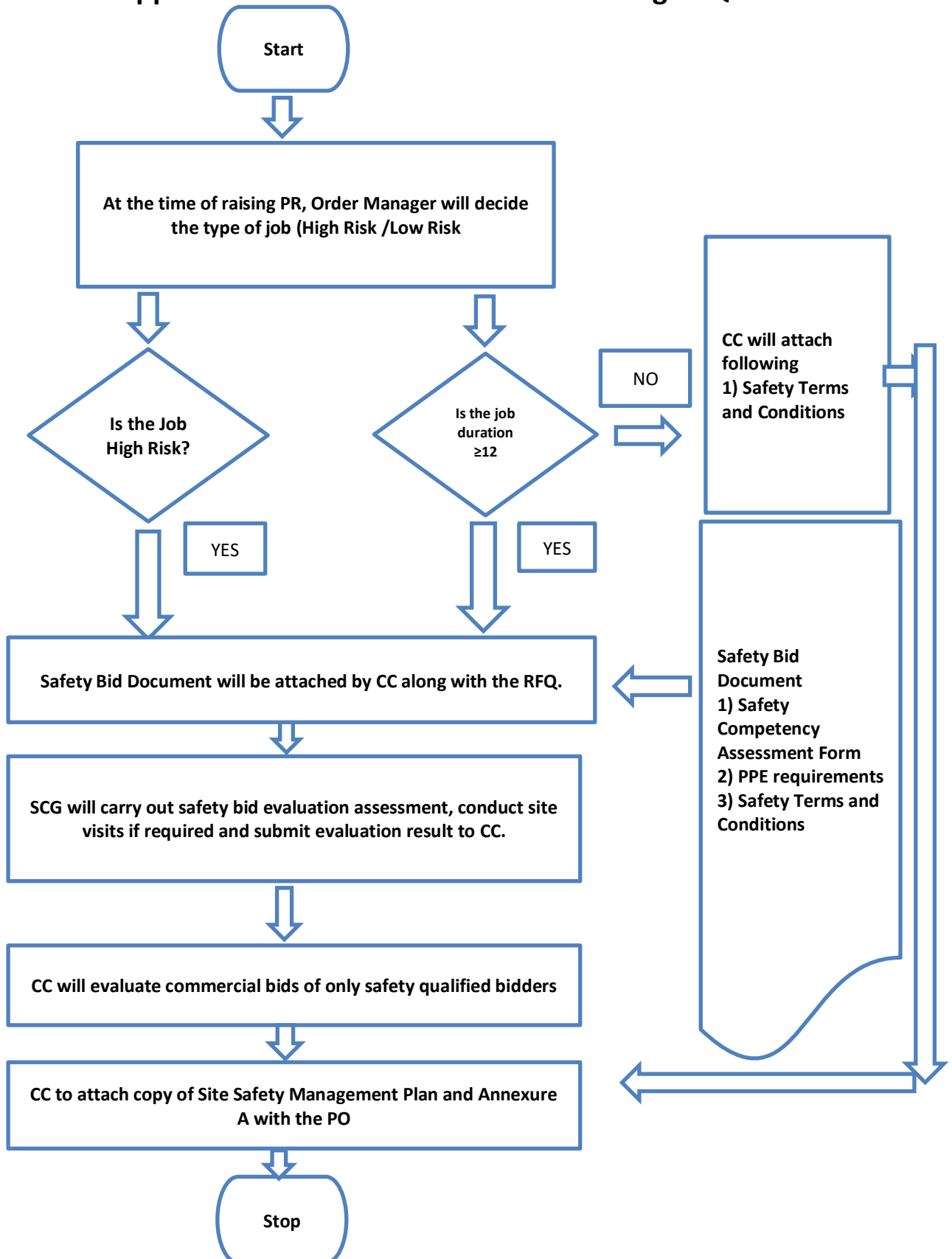

Appendix 7: CSM-F-7 Safety Competency Form (Template)

Name of the Vendor/Bidder : -

Name of the Sub Vendor (If job is given to Sub Vendor) : -

Description of the Job : -

Request for Quotation (RFQ) No. :-

Vendor/Bidder to mandatorily provide the below safety competency related information.

1. Proposed Manpower Deployment Schedule : -

Category of Manpower Deployed	Minimum Qualification & Experience	Proposed Numbers against each category month-wise			
		Month 1	Month 2	...	Month n
Project Manager					
Site-In-Charge (Site Manager)					
Shift-in-Charge					
Safety Officers					
Supervisors					
Technicians					
a.....					
b.....					
Highly Skilled Workmen					
a.....					
b.....					
Skilled Workmen					
Semi-Skilled Workmen					
Unskilled Workmen					
Total Manpower					

Instructions to Bidder to fill:

- Bidder to provide the overall site manpower deployment schedule as above.
- Bidder to indicate (through colour code mentioned below) their direct and sub-contracted employees
Direct bidder employee
Partly Direct / Partly sub-contracted
Sub-Contracted
- Against each of the category, bidder to indicate the minimum qualification and experience of the proposed manpower.
- Rows can be added to also identify other specialised manpower e.g. specific details to be included for high risk activities operators
- Columns can be extended to the actual duration of Site activities.
- Bidder to note that if operations is in shifts, then Shift-in-charge / safety officers are required for each shift of operation.

2. List of Tools, Tackles, Machines and Equipment: -

Bidder/ Vendor to provide the list of tools, tackles, equipment **to be used during the job / project execution**. Bidder/Vendor to ensure that all the lifting tools and tackles, pressure vessels are duly certified by the competent person authorised by the Chief Inspector of Factories of the respective state prior to start of the job

Sr. No.	Description of Tools / Tackles	Capacity / Rating	Quantity	Make	Remarks
1					
2					
3					
4					
5					
6					
7					
...					

3. Safety Records:

Bidder to provide the details of fatalities and lost workday cases (LWDC), occurred in last three years (data to be provided for the last completed FY and preceding 2 years).

Description	Safety Data for Last 3 Years		
	Year 1 (Last FY)	Year 2	Year 3
	20__ - __	20__ - __	20__ - __
Fatalities (Nos.)			
Lost Workday Cases (Nos.)			

In case of no fatalities, LWDC during any year, the form may be filled stating NIL against the respective year. Bidders are encouraged to also submit the RCA / incident investigation reports and the learning's implemented out of the above reported incidents

4. Job Safety Plan/ Method Statement:

Bidder to provide / enclose a detailed Site/Job Safety Plan along with a Method statement detailing the execution philosophy (how the bidder intends to execute the Job/Project), identifying all key activities which are required to be performed by the contractor at Site. Bidder to also list down all high-risk activities and provide the Hazard Identification and Risk Assessment (HIRA) for all such high-risk activities involved in the site work.

(Use Method Statement template attached as annexure A and sample as attachment B)

5. Management System Certification: -

Sr.	Certification	Yes / No	If Yes, Year of Certification	If No, Target date for Certification
	ISO 9001			
	ISO 14001			
	OSHAS 18001 / ISO 45001			
	Any other (please specify.....)			

Note: Please attach certificates to support above. In case not accredited for above but applied for, application letters may be attached.

Appendix 8: CSM-F-8 PPE requirements

The Contractor shall ensure that the following PPE of Approved standards shall be available at all time and shall be used by his employees with no exception whatsoever.

1	All contractor's employees at site	Safety Florescent Jacket (orange color), Safety helmet & safety shoes with Composite or steel toe cap
2	Workers mixing asphalt, cement, lime / concrete	Safety goggle & protective Hand gloves and footwear, Nose mask.
3	Welders / Grinders	Welding screen/goggles, safety shoes, leather hand gloves, aprons, leg guard
4	Stone breaker	Protective goggle, hearing protection, anti-vibration hand gloves and Protective clothing.
5	Electricians	Rubber hand gloves & Electrical resistant shoes.
6	Workers engaged in insulation using glass wool etc.	Respiratory mask & leather Hand gloves, goggles.
	Workers engaged in coal handling plant, ash handling plant and working in high dust area.	Dust mask, Hand gloves, protective goggles.
7	Workers working at a height of 1.8 Meter or above.	Double lanyard full body harness, fall arrestor and safety net made of reinforced nylon fiber ropes firmly supported with steel structures

• PPE shall be conforming to BIS/DGMS/DIN specifications, in good condition and shall be comfortable to his employees, when used.

Appendix 9: CSM- F-10 Site Safety Management Plan / Method Statement

Site Safety Plan / Method Statement (Template)

This Method Statement describes the specific safe working methods which will be used to carry out the described work. It gives details of work procedure with control measures to counter health and safety issues related to this work. The listed content of this Method Statement can be changed/modified subjected to job scope / specifications, but task specific method statement once finalized & approved, that should not be modified during work execution without permission from the approving authority.

Project/Job Name			
Scope of work: -			
Drawing References: -			
Detail of Sub contractors involved: -			
Method Statement Prepared By: - Designation: - (e.g. Site Manager)		<u>Signature</u>	<u>Date</u>

1.0 Introduction (*Describe purpose of the work, give details of type and scope of work being carried out;*)

2.0 Location of Work (*Give site address and precise location on site where work is to be carried out.)*

3.0 Safety Document /Specific Approval Required (*Details of any safety documents or specific approval i.e. Client specific approval required to undertake the work*)

5.0 Role & Responsibilities of Personnel/Parties Involved in activities: -Clearly define role and responsibilities of all personnel involved in activity i.e. Site management staff including subcontractors' parties- Main contractor Project/Site Manager, Sub Contractor Site Manager, Project Engineer, Safety officer, Competent Supervisory Staff)

6.0 Working/Activity Description: - *It is important that all operatives should have clear idea of those operational sequences and responsible supervisor must verify their competency prior to their engagement in operation.*

6.1 Pre-Working Checks

6.2 Resources (Equipment, tools including manpower) Details *i.e. Equipment and Tools, specific operational equipment, test kits, lifting resources, Details of materials to be used in operation, including any reference to COSHH assessments in case of use of any chemicals, Details of the manpower allocated to the task, e.g. titles, qualifications, competences, direct manpower, contractors. Details of plant, tools and equipment to be used for the work, including the availability of relevant statutory documents, checks or inspections etc. Details of fencing, barriers, cones, chains, dangers notices, warning signs etc.*

Tools required for work:

Sr.No	Tools /Equipment /Machine	UOM	Required Qty.	Remark
1				
2				
3				
4				
5				
6				
7				
8				
9				
10				

6.4 Operational Sequence of work: - Full description of the work, setting out the methodology in a sequential manner, including any reference to any identified operational restraints. Also refer here sec. 5.0 responsibilities part for every step of work sequence).







Sr.No	Activity	Details of job sequence	Risk Involved	Control Checks
1.		1.		
2.				
3				
4				
5.				

6.7 Final Checks & restoration of work area after completion of work :- Those checks to be carried out by responsible supervisor in witness of his line hierarchy by use of specific checklist of certain operational checks and once those completed satisfactory, PTW (if applicable) to be closed and isolation arrangements to be restored by removing barricades/cautionary tags.

7.0 Task Specific Hazards: - Refer to Task Specific Risk Assessment and attach in appendix

Attachment: - Specific Risk Assessment

In addition, please provide below control measures in risk assessment (as applicable).

<p>Fall Protection Measures: (Where Work at height cannot be avoided)</p>							
<p>Control Measures for Electrical Hazards</p>							
<p>Others Hazard if any (please provide details)</p>							
<p>Hazardous Substances to be used in job : (Attach MSDS if required)</p>	 Acute Toxic	 Health Hazard	 Corrosive	 Dangerous For the environment	 Oxidising	 Highly flammable	 Explosives
	Yes /No	Yes /No	Yes /No	Yes /No	Yes /No	Yes /No	Yes /No

7.0 Emergency Provisions: -Relevant operational possibility of a programme in the case of emergency situation i.e. electrical supply restoration. In addition emergency response provisions i.e. first aiders, fire fighting, and first aid arrangements, nearest onsite/offsite emergency response also to be considered during emergency planning.

8.0 "5S issues" / Waste Disposal/ Housekeeping and Environmental issues: -Details waste disposal processes and or housekeeping activities, Details of environmental impacts and control measures.

--

9.0 Personal Protective Equipment (PPE):- (Tick on PPE requirements for the task/Job

Required Personnel Protective Equipment:	 Safety Boots	 Hard Hats	 Safety Gloves	 Hearing Protection	 Eye Protection	 Respiratory Protection	Other: 1. Hi-Viz 2. Coveralls 3.
---	---	--	--	---	---	---	--

10.0 First Aid facilities and Nearby Hospitals Details

	First Aid Facilities:	Name of On-Site First Aider:	
		First Aid Box Location:	
		Location of Nearest Hospital:	

11.0 Occupational Health, Fitness and COVID-19 related Preparedness:

1. Please give a brief writeup / methodology of your organization planned to avoid impact of the COVID-19 pandemic at Tata Power working site.
2. Please give brief details of occupational health and hygiene related interventions planned by your organisation to ensure good health and fitness of workforce at Tata Power site.

Appendix 10: Process Flow Chart for Safety Performance Evaluation

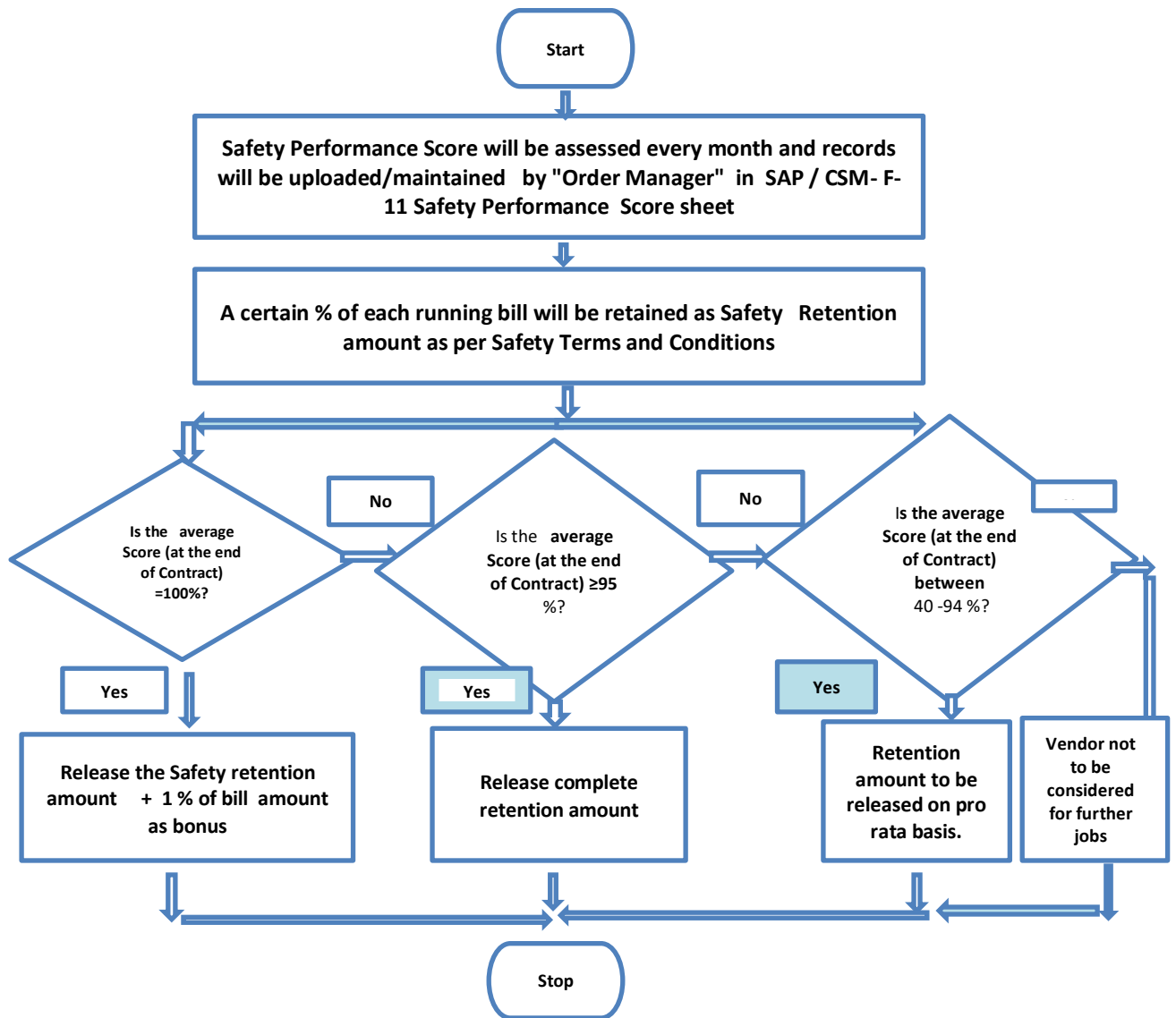

Appendix 11: CSM- F-11 Safety Performance Score

Sr. No	Parameter	Unit of Measurement	Target	Weight age	Actual Performance	Actual Score
Lead Indicator						
1	% of Employee certified in TPSDI/Authorized agency	Number	50%	10		
2	CFSA score (Annexure 6.1)	Average Severity of Violations	1.49	20		
3	Monthly inspection completed for Critical Equipment, lifting Tools & Tackles and hand tools used at site	Number	80%	10		
4	Condition of critical tools, tackles and equipment	Number	100%	10		
Lag Indicator						
1	Number of Fatalities	No	0	30		
2	Number of Lost workday case (LWDC) (reportable)	No	0	10		
3	Man-days Lost	Man-days	0	10		
					Final Score	
					Invoice Value	
					Amount to be released	

Safety Performance Evaluation Criteria

Lead Indicators

	Target			
% of Employee certified in TPSDI/Authorized agency	50%	100%	Less than 100%	
Score		10	5	
	Target			
CFSA score	<=1.49	1.5 to 2.5	2.51 to 3.5	>=3.51
Score	20	15	10	0
	Target			
Monthly inspection completed for Critical Equipment, lifting Tools & Tackles and hand tools used at site	>=80%	79 to 50%	<50%	
Score	10	7	0	
	Target			
Condition of critical tools, tackles and equipment	100%	<100%		
Score	10	0		

Lag Indicators

Number of Fatalities	0	>0	
Score	30		0
Number of LWDC (reportable)	0	>0	
Score	10		0
Number of man days lost	0	1 to 5	>5
Score	10	5	0

Appendix 12: CSM-F-5 Safety Potential Evaluation Criteria for Vendor Registration

At the time of vendor registration, vendor will be registered under 3 categories

- 1) **Category A**- Vendors eligible to carry out High risk Jobs
- 2) **Category B**- Vendors eligible to carry out technical jobs that are low risk
- 3) **Category C**- Vendors eligible to carry out administrative and office jobs
- 4) **Category D**- Outsourced Jobs / Consultants /Medical Practitioners / Suppliers etc

For vendors to be registered under **Category A**, a safety potential evaluation will be carried out based on following parameters.

Sr. No	Description	Weight	Actual	Remarks
		age (%)	Score	
1	Does the contractor have a valid ISO 45001/ OHSAS 18001/ Certification?	30		
2	During site visit check for safety adequacy at site	30		Annexure - 12.1
3	Check the Safety statistics of Contractor	10		Annexure - 12.2
4	Check the Safety orientation & training process of Contractor	15		Annexure 12.3
5	Check the organizational structure for safety professionals & engineers / supervisors.	10		Annexure - 12.4
6	Certified/skilled workers as a percentage of overall workforce	5		
Total		100		

Evaluation Criteria for Category B

Sr. No	Description	Weight	Actual	Remarks
		age (%)	Score	
1	Does the contractor have a valid ISO 9001 certification?	30		
2	During site visit check for safety adequacy at site	30		Annexure -12.1
3	Check the Safety statistics of Contractor	10		Annexure -12.2

The Tata Power Company Ltd		<i>Contractor's Safety Code of Conduct</i>
Document No. TPSMS/GSP/CSM/015 REV 05		Date of Issue: 30/07/2020

4	Check the Safety orientation & training process of Contractor	15		Annexure -12.3
5	Check the organizational structure for safety professionals & engineers / supervisors.	10		Annexure -12.4
6	Certified/skilled workers as a percentage of overall workforce	5		
	Total	100		

Evaluation Criteria for Category C

Sr. No	Description	Weight age (%)	Actual Score	Remarks
2	Check the Safety statistics of Contractor	40		Annexure - 12.2
3	Check the Safety orientation & training process of Contractor	20		Annexure - 12.3
	Total	100		

Annexure 12.1: Evaluation Criteria for Category D:

Category D does not require any evaluation as it is for outsourced job outside the Tata Power company premise.

Annexure 12.2

Check List – Adequacy of Safety Statistics of Service Provider			Actual Marks obtained	Remarks
Sl. No	Description	Marks		
1	Check the safety statistics for last 3 years (LTIFR and LTISR)	Statistics available	5	
		Statistics not available	0	
2	Check the trend LTIFR for last 3 years	LTIFR value	Marks	
		0 to 0.2	5	
		0.21 to 0.3	2.5	
		>0.3	0	
3	Check the trend of LTISR last 3 years	LTISR value	Marks	
		0 to 2	5	
		2 to 3	2.5	
		>3	0	
4	Has there been any Prosecution/Conviction for any contravention with regard to Safety & Health provisions under the Factories Act /Electricity Act/ BOCW Act and Rules framed there under?	No Prosecution	10	
		Prosecution	0	
		To be provided in written on letter head		
	Total		25	

Annexure 12.3

Check List – Adequacy of Safety orientation & training process of Service provider			Actual Marks obtained	
1	Records of safety trainings provided to safety officer/supervisor/workmen during last 1 year as percentage(%) of total employed by service provider	Safety Officer	Marks	
		≥80% of employees	5	
		50 to 79 % of employee	2.5	
		<50%	0	
		Safety Supervisor	Marks	
		≥80% of employees	10	
		50 to 79 % of employee	6	
		<50%	0	
		Workmen	Marks	
		≥80% of employees	10	
		50 to 79 % of employee	6	
		<50%	0	
Total			25	

Annexure 12.4

Check List – Adequacy of organizational structure for safety professionals & engineers / supervisors.			Actual Marks obtained	
1	Check availability of number of safety officers from government recognized institute as per workforce strength.	Marks		
		1 in 50 employees		10
		1 in 100 employee		6
		Any other		0
3	Check availability of qualified workforce from government recognized institute/TPSDI.	Marks		
		100% of safety officers qualified		5
		50 – 99% of safety officers qualified		3
		<50		0
Total			15	

Appendix 13: CSM-F-9 Safety Bid Evaluation Criteria.

The User has to select whether the job is high risk/ long duration at time of raising the PR.

- 1) The decision whether job is “**high risk**” or not has to be made by order manager on the basis of Risk involved (Risk Priority Number in HIRA) of the Jobs. An indicative list of high-risk jobs is attached as annexure
- 2) If a technical job is of low risk with estimated duration of the contract is 1 year or more the job should be treated as “**long duration**”.
- 3) All Safety bids will be evaluated by Safety Concurrence Group. Structure of SCG will be declared by Corporate safety. Corporate safety team will audit bid evaluation process of a few selected jobs and Quality of evaluated safety Bids.
- 4) Records of jobs sent by for Safety Bid evaluation shall be maintained by Corporate Contract team in existing tracing sheet along with other jobs.
- 5) For Safety Bid Evaluation will be based on following parameters.

		Minimum Requirement	Weight age (%)	Score Obtained
Manpower	Safety Officer (1 per 500 workers)	<p>Qualification- Officer shall possess Advance Diploma In Industrial Safety by state technical board.</p> <p>Experience- Minimum 1-year experience in relevant field as mentioned in the job in PR.</p>	5	
	Safety Supervisor (1 per work site up to max. 50 workers)	<p>Qualification- Supervisor shall possess ITI/ Diploma in relevant field.</p> <p>Experience- Minimum 2-year experience in relevant field as mentioned in the job in PR.</p> <p>Training – Trained and certified by TPSDI or equivalent institute in relevant safety procedures.</p> <p>Note: On request of the contractor/Users -TPDSI should vet & certify the skilled & experienced</p>	5	

		Technician if Technical Qualification is not adequate.		
	Technician (Skilled workers as electrician, rigger, fitter, welder, cable jointer, line men etc)	Experience- Minimum 2 year experience in relevant field as mentioned in the job in PR. Training – Trained and certified by TPSDI or equivalent institute in relevant safety procedures.	5	
Tools & Tackles	Equipment / Machines/ Tools & Tackles(lifting and shifting tools)	The list of Equipment /Machines / Tools and tackles to be used for job to be submitted by the contractor. Evaluation of the list will be carried out based on 1) Suitability as per the relevant job 2) Make and age of the tools from authorized agencies defined by the user. 3) Certification by the competent authority of respective state.	30	
Safety Records	Safety Records	Safety Records for last 3 years (as per vendor or as per our knowledge) – Recommendation?	15	
Safety Plan	HIRA/Contract Job Safety Plan	Adequacy of HIRA and Job Safety Plan with respect to relevant job. More weight age will be given to vendor for using mechanized work and advanced tools and equipment	20	
Accredited Bodies certificate	ISO-9001	ISO-9001	2	
	ISO-14001	ISO-14001	3	
	OHSAS 18001 ISO 45000	OHSAS 18001/ISO 45000	15	
Total Score				

6) Vendor entitled to carry out the job only when qualified for the safety evaluation as follows:

Contractor is qualified in safety bid only if his total score is more than 70% in all category 1 jobs such as high risk/long duration.

- 7) The Corporate Contract has to ensure that the vendor provides the filled "Safety Competency Form" along with the quotation.
- 8) Corporate Contract will forward the Safety Competency Form received from the contractor to the Safety Concurrence Group for evaluation.
- 9) In case SCG wants to visit the site, the Safety Competency will be based on evaluation at the time of site visit Annexure 13.1

Annexure -13.1:

Checklist to be used: During site visit to check the adequacy Safety systems.			
		Observation	Score* (1-5)
1	Check the adequacy of safety policy and Safety Management system of the contractor.		
2	Does the contractor have written down safety procedures?		
3	Check the records of Near miss, unsafe act, unsafe conditions and incidents.		
4	Check the organization setup to implement the safety systems at site (safety officer, safety supervisor)		
5	Check whether safety meeting and toolbox talk carried out regularly and records maintained or not.		
6	Is the process of incident investigation adequate or not?		
7	Verify incident reporting and recording system		
8	Check the usage of equipment/tools and tackles.		
9	Check for housekeeping at site		
10	Check the use of PPEs and general behavior of workforce towards safety		
	Total Score		
	Site Visit Score		

Score*- rating on the scale of 1-5 to be given based on the observations on site. Score of 1 is the lowest and core of 5 is the highest.



Appendix 14: CSM-F-11.1 CFSA Format

CONTRACTOR FIELD SAFETY AUDIT												
Project Name :												
Date:												
Description of Severity rating:						Audit Team:						
	1 = Untidy area, minor issues, sets poor example											
	2 = Restricted access, unacceptable trash, disorderly											
	3 = Rule or procedure violation, potential injury											
	4 = Unsafe condition, serious injury potential											
	5 = Immediate serious injury potential, stop activity immediately and correct					Audit Time:			10:00hrs -11:30 hrs			
						Weather:			cloudy			
Area	Description	Responsible		Number Personnel Observed		Violations			Remarks	Leading Indicators		
		Engineer	Contractors	Good Citizens	Violators	Number of Violations	Severity	Violations x Severity		4 & 5	PPE	Unsafe Act
1												
	Sub Totals			0	0	0	0	0		0	0	0
	% of Observed People Working Safely											
	Number of Violations											
	Average Severity of Violations											
	Number of Severity 4 & 5 Violations											
	% of 4 & 5 Violations											
	Approximate Number of Workers Observed											
	Number of People on Site											
	% of Workers Observed											

Appendix 15: Indicative List of High-Risk Jobs

To access the exhaustive list of High-risk jobs, please refer the following documents

- 1) High Risk Jobs- Generation
- 2) High Risk Jobs- T&D
- 3) High Risk Jobs- Renewable

Indicative List of High-Risk Jobs -Generation Cluster				
Sl. No.	Jobs			
1	Demolition / Painting of Chimney			
2	Survey Sounding Jobs in Sea			
3	Dredging at Coal Birth Jetty			
4	Maintenance / Testing and Replacement of Extra High Voltage (132 KV etc.) Switchyard equipment			
5	Maintenance of EOT Cranes			
6	Deep excavation (5 feet or more) near existing buildings /Structure s			
7	Working inside confined spaces (entry through manhole)			
8	Operation Maintenance of elevators			
9	Working on Live control Circuits for identification of faults			
10	Cable laying and termination Jobs			

Indicative List of High-Risk Jobs - T&D Cluster				
Sl. No.	Jobs			
1	Transmission Line Tower Erection on columns, near live lines, In congested areas, In creeks, In the Sea			
2	Conductor Stringing on Tower Using Tensioner & Puller in the area such as Line Crossing, Near Live lines, Congested Areas, Road Crossing, Bridge Crossing, Railway line Crossing, In creeks ,In the Sea			
3	Cable Pulling by Using winch Machine in City and Rural Areas			
4	Hot Washing of HT and Extra HT lines, Towers and switchyards equipment			
5	Installation of Lifts			
6	Installation of EOT Cranes			
7	Tower Dismantling			
8	Working on H Frame /Pole mounted Transformers			
9	Excavation in operational Area heaving power cables in receiving station			
10	Identification and spiking of cable / disconnection of cables from poles			

Indicative List of High-Risk Jobs - Renewable Cluster

Sl. No.	Jobs				
1	Working on Electrical Panels				
2	Hi Potting of Equipment				
3	Battery commissioning and maintenance				
4	Working on the nasal of Wind Turbine				
5	Working on live electrical switchyard, material Handling and Equipment installation				
6	Roof Top Solar Panels Installation and maintenance				
7	Working in live Electrical Switchyard, Material Handling, equipment installation				
8	All maintenance activities that requires climbing on Towers /Structures / Transformer/ GODs				
9	Loading and Unloading of Solar Panels on trucks				
10	Structural Repair /Dismantling work at height.				

Annexure IX

Tata Code of Conduct (TCoC)

TATA CODE OF CONDUCT

The Owner abides by the Tata Code of Conduct in all its dealing with stake holders and the same shall be binding on the Owner and the Contractor for dealings under this Order/ Contract. A copy of the Tata Code of Conduct is available a tour website:

<https://www.tatapower.com/pdf/aboutus/Tata-Code-of-Conduct.pdf>

The Contractor is requested to bring any concerns regarding this to the notice of our Chief Procurement & Stores e-mailID: pravin.jain@tpcentralodisha.com.

Annexure X

Environment & Sustainability Policy

ENVIRONMENT & SUSTAINABILITY POLICY



CORPORATE ENVIRONMENT POLICY

Tata Power is committed to a clean, safe and healthy environment, and we shall operate our facilities in an environmentally sensitive and responsible manner. Our commitment to environmental protection and stewardship will be achieved by:

- Complying with the requirements and spirit of applicable environmental laws and striving to exceed required levels of compliance wherever feasible
- Ensuring that our employees are trained to acquire the necessary skills to meet environmental standards
- Conserving natural resources by improving efficiency and reducing wastage
- Making business decisions that aim towards sustainable development
- Engaging with stakeholders to create awareness on sustainability

A handwritten signature in blue ink, appearing to read 'Praveer Sinha', with a horizontal line underneath.

(Praveer Sinha)
CEO & Managing Director

Date: 15th June, 2018

TATA POWER
Lighting up Lives!





CORPORATE SUSTAINABILITY POLICY

At **Tata Power**, our Sustainability Policy integrates economic progress, social responsibility and environmental concerns with the objective of improving quality of life. We believe in integrating our business values and operations to meet the expectations of our customers, employees, partners, investors, communities and public at large

- We will uphold the values of honesty, partnership and fairness in our relationship with stakeholders
- We shall provide and maintain a clean, healthy and safe working environment for employees, customers, partners and the community
- We will strive to consistently enhance our value proposition to the customers and adhere to our promised standards of service delivery
- We will respect the universal declaration of human rights, International Labour Organization's fundamental conventions on core labour standards and operate as an equal opportunities employer
- We shall encourage and support our partners to adopt responsible business policies, Business Ethics and our Code of Conduct Standards
- We will continue to serve our communities:
 - By implementing sustainable Community Development Programmes including through public/private partnerships in and around our area of operations
 - By constantly protecting ecology, maintaining and renewing bio-diversity and wherever necessary conserving and protecting wild life, particularly endangered species
 - By encouraging our employees to serve communities by volunteering and by sharing their skills and expertise
 - By striving to deploy sustainable technologies and processes in all our operations and use scarce natural resources efficiently in our facilities
 - We will also help communities that are affected by natural calamities or untoward incidence, or that are physically challenged in line with the Tata Group's efforts

The management will commit all the necessary resources required to meet the goals of Corporate Sustainability.

(Praveer Sinha)
CEO & Managing Director

Date: 15th June, 2018

TATA POWER
Lighting up Lives!





**SUPPLIER MANUAL ANSWERING
TO
E-BIDDING & E-AUCTION**



	Version 1.1
Company Confidential	DEC - 2016

INDEX

1 ACCESSING ARIBA SOURCING	3
2 VENDOR SCREEN.....	4
3 SUBMITTING YOUR ANSWERS / PROPOSAL.....	4
<i>3.1.1 Review and Approve “Prerequisites”</i>	<i>6</i>
<i>3.1.2 Select Items or Lots</i>	<i>6</i>
<i>3.1.3 Entering Your Prebid</i>	<i>7</i>
<i>3.1.4 Entering Your Prebid for e-auction.....</i>	<i>8</i>
<i>3.1.5 Participate to the e-auction</i>	<i>9</i>
3.1.5.1 How to submit a price.....	9
3.1.5.2 What to do If you have a problem during the e-auction?	10
4 COMMUNICATING WITH UPM NEGOTIATOR.....	10
5 SUPPLIER FREQUENTLY ASKED QUESTION	11

1- Accessing Ariba Sourcing

Step 1: You will get an invitation to your email from Ariba System. Keep this email, it contains your login Information and a direct link to Ariba.

Step 2: Click "Click Here" to access the Ariba Web Site.

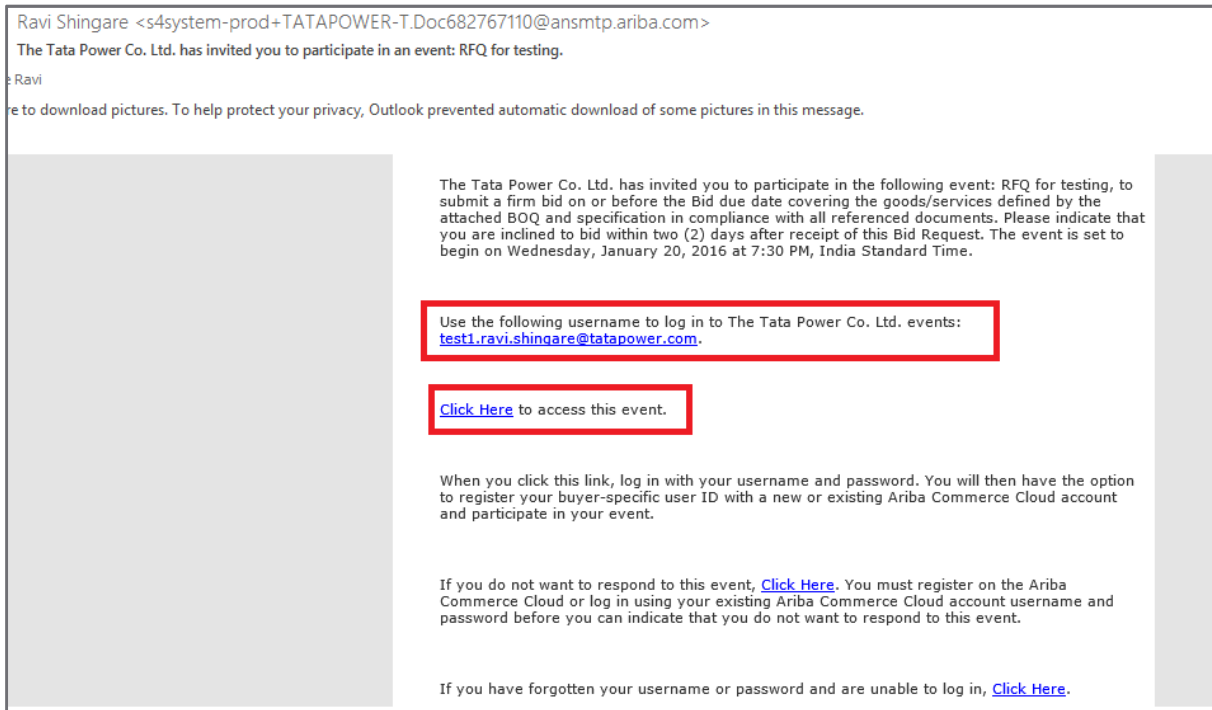

Step 3: Supplier has to click on "Continue"

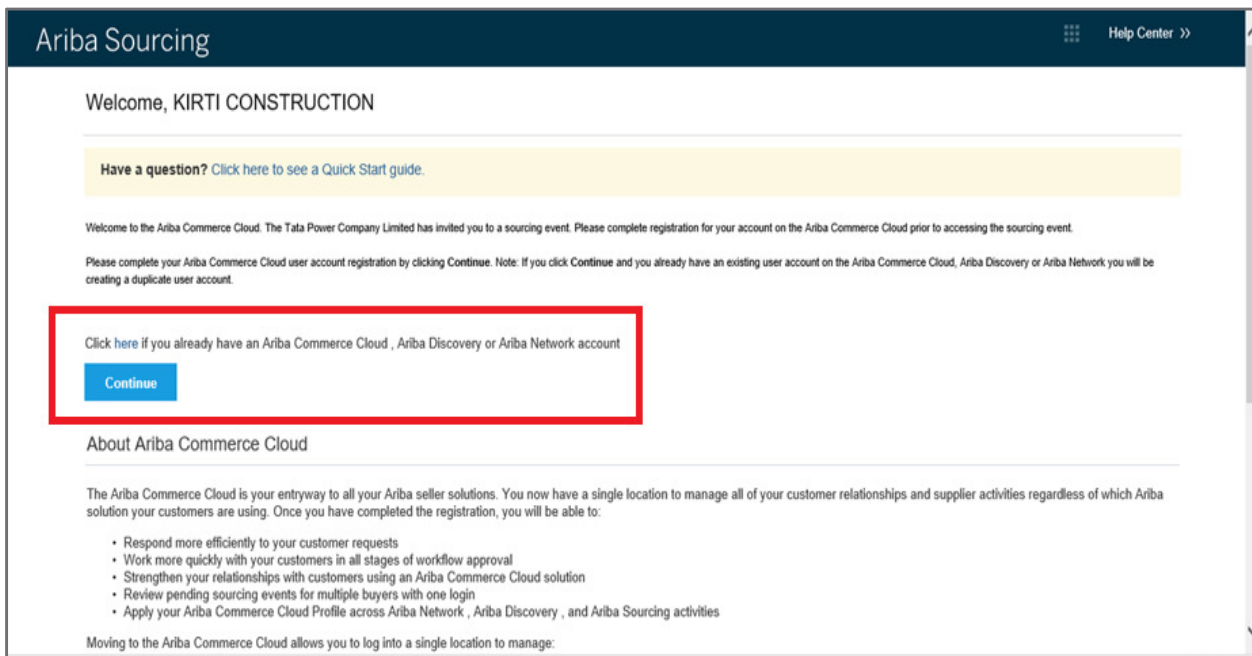

Step 4: The registration process only takes a few moments, with a simple one-page registration. Define your password and secret question. Click “OK”

* Indicates a required field

Company Name*

Country* If your company has more than one office, enter the main office address. You can enter more addresses such as your shipping address, billing address or other addresses later in your company profile.

Address*

City*

State

Postal Code*

Product and Service Categories* -or-

Ship-to or Service Locations* -or-

Tax ID: Enter your Company Tax ID number.

DUNS Number: Enter the nine-digit number issued by Dun & Bradstreet. ⓘ

Supplier has to fill the form

 **ARIBA*** SPEND MANAGEMENT Help | Logout

Welcome USER_TEST2 - UPM-Kymmene Corporation

Expired Password

Your password has expired. Follow these instructions to complete this step: Create a new password and confirm. Select a secret question and answer it so ...

Passwords are case-sensitive, and must be between 8 and 16 characters long. They can include any Latin characters and punctuation marks, and must include at least one numeral between the first and last character. They must also include at least one letter. For example, go2enba.

The current secret answer that you have entered is different from the one that has been recorded for this user.

New Password*

New Password (confirm)*

Secret Question* ⓘ

Secret Answer*

(* indicates a required field)

You expressly agree and understand that your data entered into this system may be transferred outside of the European Union or other jurisdiction where you are located, as further described in the Ariba Data Policy [Data Policy](#)

Step 5: If it's the first time you are invited to use UPM Ariba, you'll need to accept the “Participant Terms”. Select “I accept the terms of this agreement”. Click “Submit”.

Secret Question* The answer to your secret question must be atleast 5 characters.

Language: The language used when Ariba sends you configurable notifications. This is different than your web b...

Ariba will make your company profile, which includes the basic company information, available for new business opportunities to other companies. If you want to hide your company profile, you can do so anytime by editing the profile visibility settings on the Company Profile page after you have finished your registration. By clicking the Submit button, you expressly acknowledge and give consent to Ariba for your data entered into this system to be transferred outside the European Union, Russian Federation or other jurisdiction where you are located to Ariba and the computer systems on which the Ariba services are hosted (located in various data centers globally), in accordance with the Ariba Privacy Statement, the Terms of Use, and applicable law.

You have the right to access and modify your personal data from within the application, by contacting the Ariba administrator within your organization or Ariba, Inc. This consent shall be in effect from the moment it has been granted and may be revoked by prior written notice to Ariba. If you are a Russian citizen residing within the Russian Federation, You also expressly confirm that any of your personal data entered or modified in the system has previously been captured by your organization in a separate data repository residing within the Russian federation.

I have read and agree to the [Terms of Use](#) and the [Ariba Privacy Statement](#)

2 Vendor Screen

2.1.1 If vendor goes through mail invitation then directly Screen 3.1.1 will appear, but if you have used Ariba before and have already accessed an event for the buyer-specific account with your current log in ID, click the **Login** button to continue. Log in with your Ariba username and password in order to participate in the event OR you have to follow the following steps.

Step 1 - Log on supplier.ariba.com

Step 2 - Put your USER ID and Password in following screen

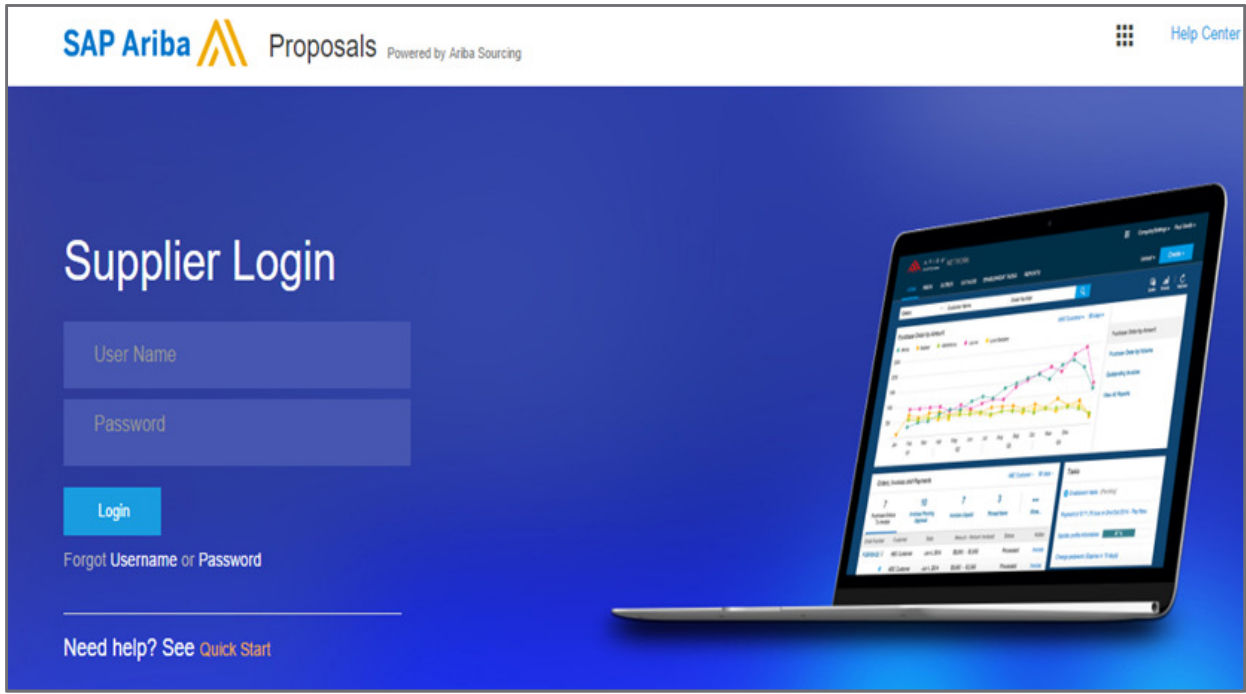

Step 3 - Go to ARIBA APPS  and click on Proposals.

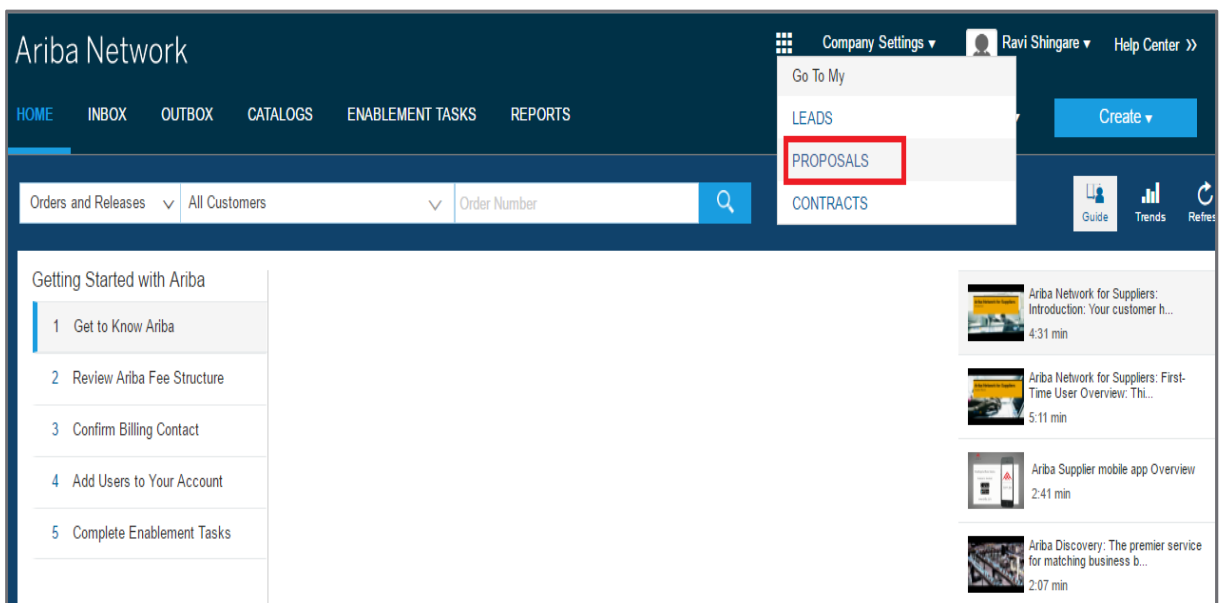

3 Submitting Your Answers / Proposal

3.1.1 Review and Approve "Prerequisites"

Step 1: Review and download all documents & then Click on "Review Prerequisites"

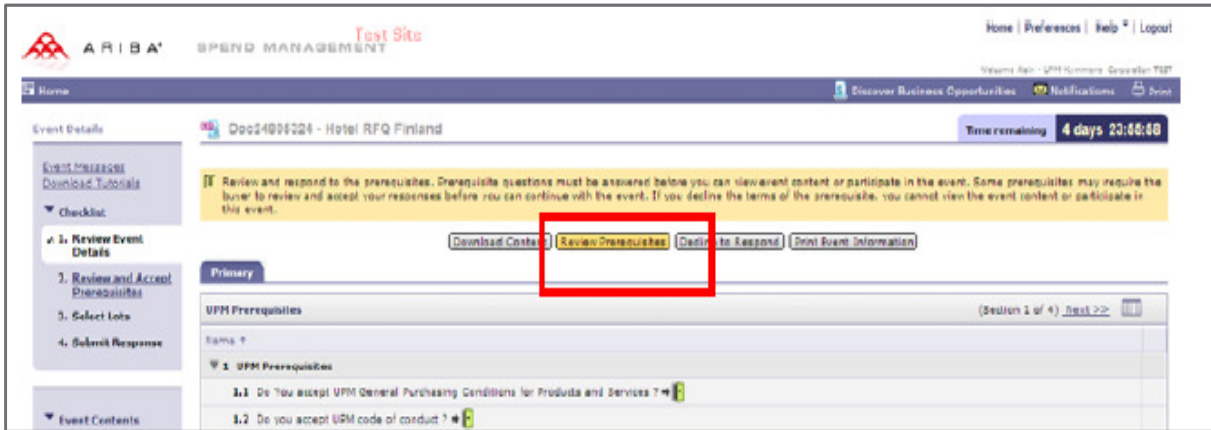

Step 2: Review and accept "Bidder Agreement".

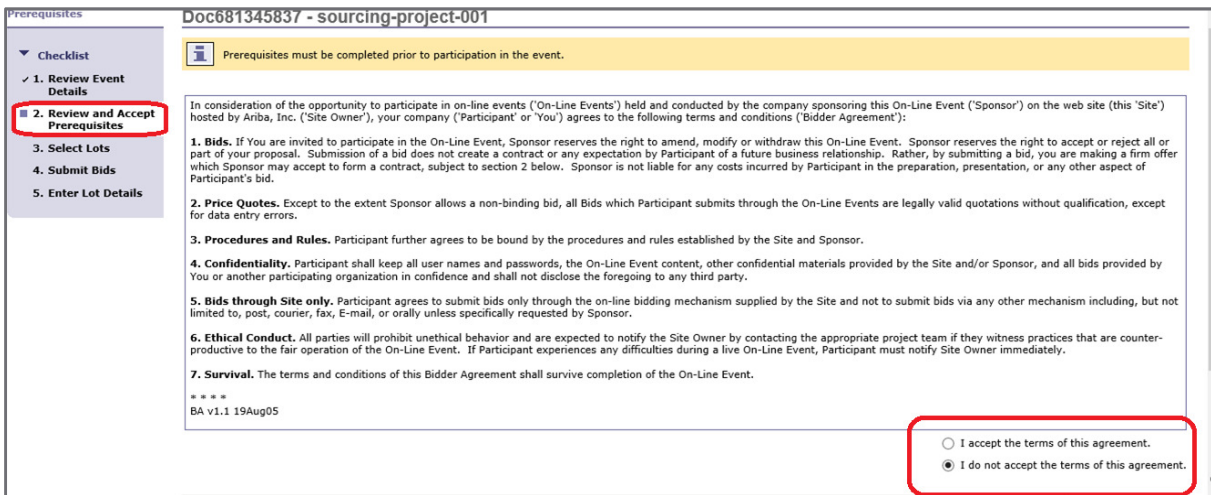

3.1.2 Select Items or Lots

Step 1: Select Items. - If you do not want to quote for any items/lots then you do not select that lot / items and then go ahead for select and submit lot.

Step 2: Click "Submit Select Lots".

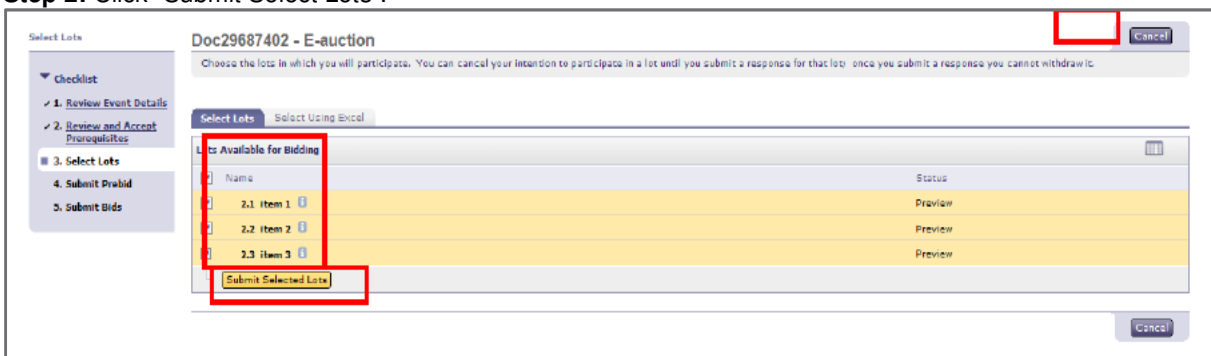

3.1.3 Entering your offer for RFQ

Step 1: as per following screen Vendor Dashboard will appear where RFQ from TATA Power will be visible.

The screenshot shows the Ariba Sourcing Vendor Dashboard. The header includes 'Ariba Sourcing', 'Test Mode', 'Company Settings', and the user 'Ravi Shir'. A red box highlights 'THE TATA POWER COMPANY LIMITED-TEST' in the top navigation. The main content area includes a welcome message, an 'Events' table, and a 'Tasks' table. A red box highlights the 'End Time' column in the Events table, showing '12/16/2016 6:36 PM'. Another red box highlights the 'Status: Open (1)' row in the Events table, which contains the RFQ 'RFQ-Test 11th Aug 2016'. A third red box highlights a text box with the instruction 'Vendor has to complete the vendor registration FORM'.

Step 2 - Follow all the steps of 3.1.1 to 3.1.3

Step 3 - Vendor has to submit their techno commercial offer in 2.1. In this field Do No attach any price content. For Price Bid put all the unit price and taxes and duties in provided field. Put "0" (ZERO) in not applicable field.

The screenshot shows the 'Event Contents' section. The left sidebar shows steps: 2. Review and Accept Prerequisites, 3. Select Lots, 4. Submit Response. The main content area shows a tree view of event items. A red box highlights item 2.1 'Please attach the Techno-Commercial Bid' with an 'Attach a file' button.

The screenshot shows the 'Price Bid' section. The top part shows instructions for bidders to specify prices in terms of percentage or value. Below is a table of items with their respective prices and units.

Item ID	Description	Price	Unit
3.2	Bearingfor motor 1.90991	15,000.00	30 each
3.3	AMC 20,000 IS-U/CCS CONTRACTS	35,000.00	35 month
3.4	ANALYSIS TAILRACE WTR SAMPLE	35,000.00	45 each

Step 4 - After successfully putting Techno commercial offer and price part then click on "Submit Entire Response"

The screenshot shows the 'Submit Entire Response' button, which is highlighted with a red box. Other buttons visible are 'Update Totals', 'Save', and 'Compose Message'.

3.1.4 Entering Your Prebid for e-auction

Before participation to the e-auction you must place a pre-bid. If you haven't placed a Prebid in the Prebid time you won't be able to participate to the auction itself.

Step 1: Populate Your Answers.

Step 2: Click "Submit Entire Response".

The screenshot shows the 'Doc681345837 - sourcing-project-001' dashboard. A yellow banner at the top right indicates 'Time remaining in preview 1 day 04:05:05'. A message states: 'The event owner has requested that you submit a prebid before the end of the preview period. You have not yet submitted a prebid.' The left sidebar contains a checklist with '4. Submit Bids' highlighted. The main content area shows a table with columns 'Name' and 'Extended Price'. The table includes sections for '1 Introduction', '2 Commercial Terms' (with a sub-item '2.1 lot-1' for '4 core cable' at '5000 INR'), and '3 Pricing' (with a sub-item '3.1 FOR SITE DELIVERY P&F INCLUSIVE' and a file upload 'COMP-1.xlsx'). At the bottom, the 'Submit Entire Response' button is highlighted.

When the Prebid time is still open you can still modify your Prebid:

Click on "revise Prebid" and repeat in step 1 and step 2.

The screenshot shows the same dashboard after a prebid has been submitted. A green banner at the top right indicates 'Time remaining in preview 1 day 04:02:39'. A message states: 'Your prebid has been submitted. You will be notified when the event is open for bidding.' The left sidebar checklist now has '4. Submit Bids' highlighted. The main content area table is updated to show '5,000.00 INR' for the '2.1 lot-1' item. A 'Revise Prebid' button is highlighted in the center of the screen.

3.1.5 Participate to the e-auction

If you have placed a bid in the Prebid time you will be able to participate to the e-action. E-auctions are rather sort in time (usually less than 20 min per item). Once the time is closed you won't be able to bid anymore.

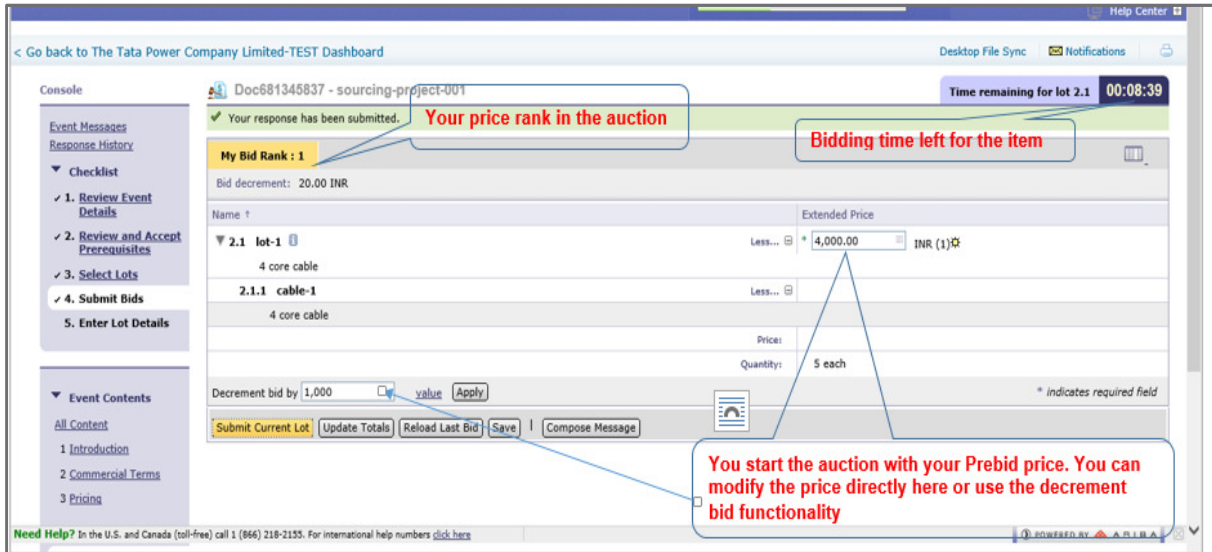

When you want to submit your price presses "submit current lot"

In case the new price you submit is lower by 10% of the starting price (Prebid Price) the following warning Message will be displayed.

To submit the new price, check the box and press submit. If you made a mistake press cancel so that you Mistake would not be submitted.

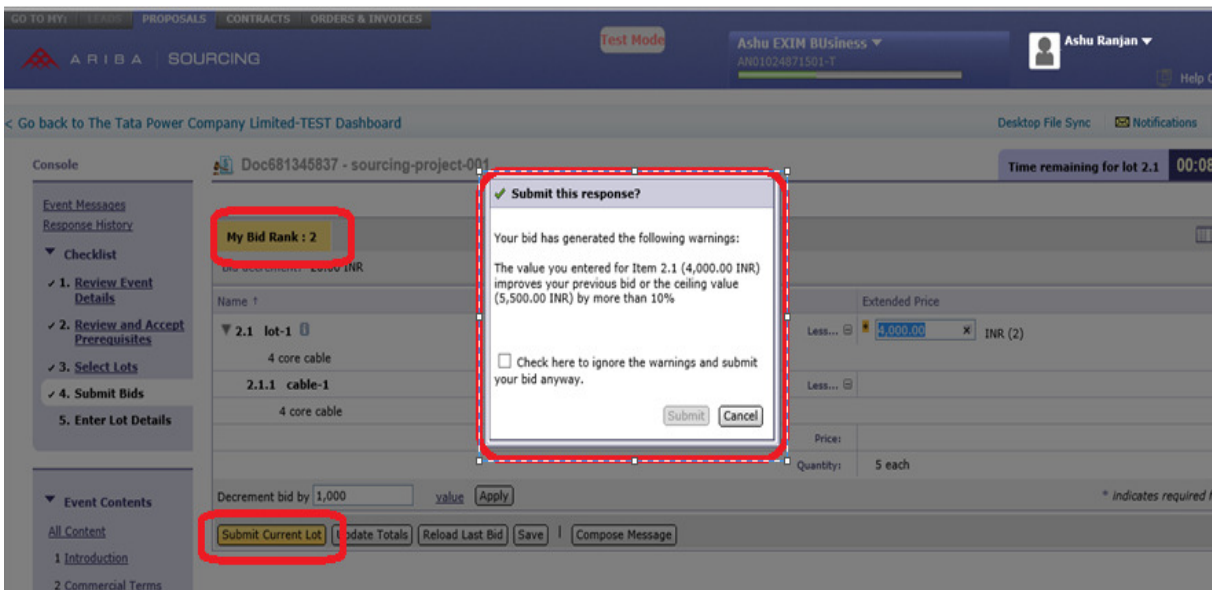

3.1.5.2 What to do if you have a problem during the e-auction?

If you have any problem related the system: - **Call first Tata Power e- Bidding / Auction Cell**

➤ **e- Bidding /Auction Cell details:-**

Core team		
Contact Person	E-Mail Id	Contact Details
Ravi Shingare	ravi.shingare@tatapower.com	9029004168
Himanshu Ranjan	himanshur@tatapower.com	9820339961
Escalation Matrix		
Paresh Bhatt	pareshbhatt@tatapower.com	
C T Prakash	ctprakash@tatapower.com	9223545185

4 Communicating with Tata Power Buyer & Auction team during auction / e- bidding

Step 1: Click “Compose Message”.

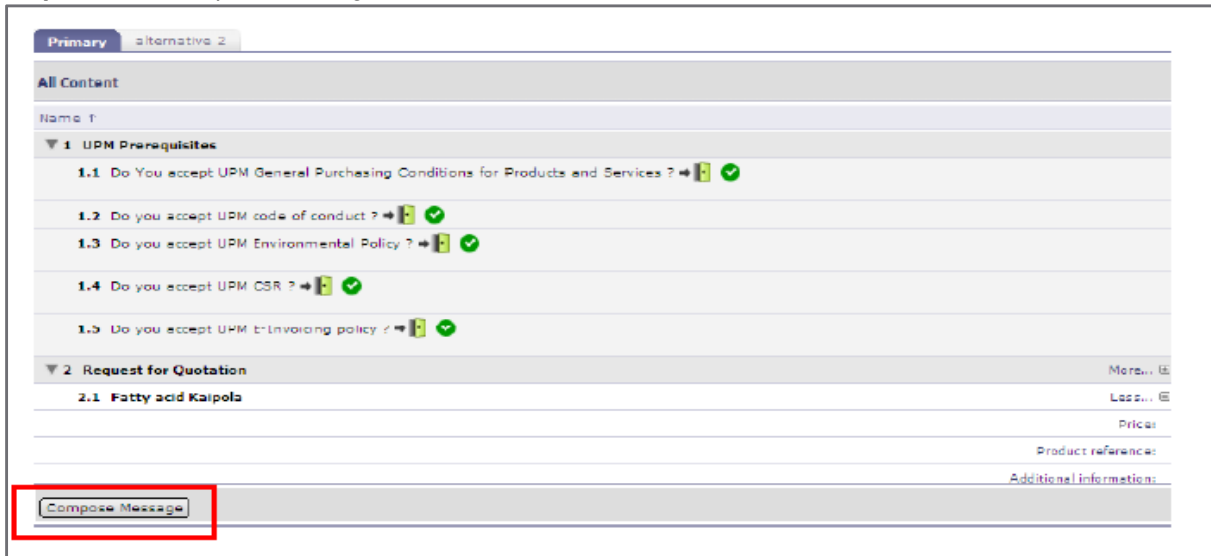

Step 2: Compose Your Message and click “Send”.

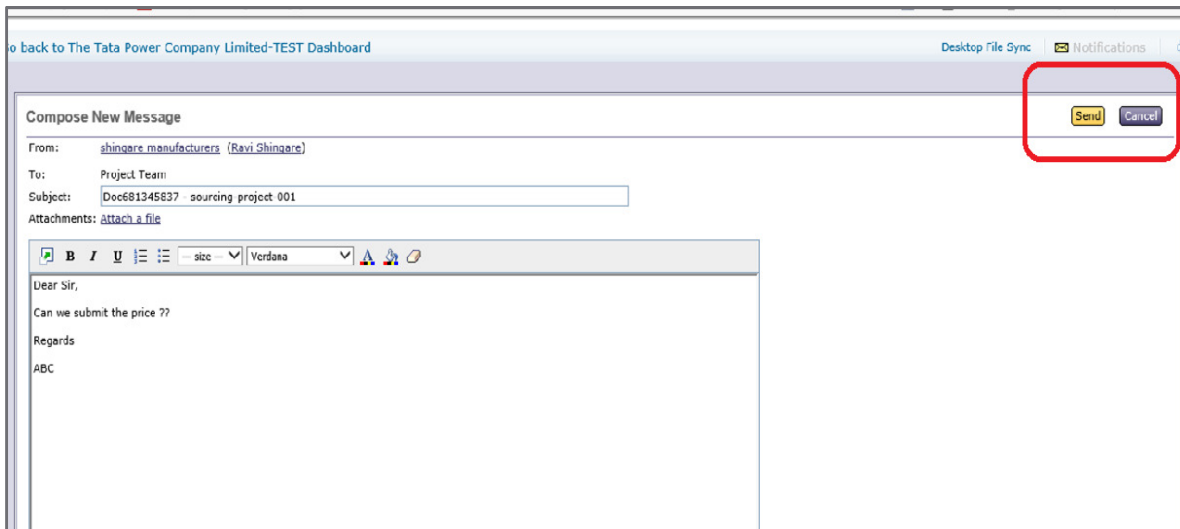

SUPPLIER FREQUENTLY ASKED QUESTIONS

If I registered on my buyer's Ariba Sourcing site in the past, do I need to register again?

Answer- Yes. Although you have registered on your buyer's Ariba Sourcing site in the past, registering on the Ariba Commerce Cloud is required. The registration process only takes a few moments, with a simple one-page registration. Registering on the Ariba Commerce Cloud gives you access to all your buyer relationships with one username and password.

What is the Ariba Commerce Cloud?

Answer: - The Ariba Commerce Cloud is your entry point to all of your seller solutions. Rather than managing log in information for multiple buyers' sites, you will have one log in and one account. This means fewer passwords to remember, easier user maintenance for your company, and a unified profile for your organization.

Do I need to add Product and Service Categories during registration?

Answer:-Yes; this is a required field. Product and Service Categories classify what your company sells, and the system uses this information to match potential business opportunities with your products and services.

Click **Add Product and Service Categories** to select one or more categories from the list of options. During registration, you only need to choose one category, preferably related to the event you are joining. You can add, refine, or remove categories any time after the registration process.

Do I need to add ship-to or service locations during registration?

Answer: - Yes; this is a required field. Ship-to or Service locations inform buyers where your company sells its products or provides its services, and the system uses this information to match potential business opportunities with your products and services.

Click **Add Ship-to or Service Locations** to select one or more sales territories from a list. You can add, refine, or remove ship-to or service locations any time after the registration process.

Do I need to enter a D-U-N-S number when I register?

Answer: - No; this is an optional field. You are only required to complete the fields marked with an asterisk (*). If you enter a D-U-N-S number, and you get a message that the value is already in use, leave the field blank, as D-U-N-S numbers must be unique within the Ariba Commerce Cloud. Your company can have multiple Ariba accounts, but only one account can use the D-U-N-S number.

Additional Information: - D-U-N-S is a registered trademark of Dun & Bradstreet or its subsidiaries in the United States and other countries.

Do I need to enter a Tax ID when I register?

Answer: - No, the Tax ID is an optional field. You are only required to fill in the fields marked with an asterisk (*).

What is the difference between the Email and Username fields in my profile?

Answer: - The Email field represents the email address where you wish to receive email notifications. The Username field is the identifier that you use to access your account. The Username field must be in email format, but you do not have to use a valid email address.

Note: Leave the **This is my username** box checked if you want your email address to be the same as your username.

How do I participate in my buyer's event using an email invitation?

Answer: - Use the **Click here** link in the email notification to access the sourcing event.

While buyers might customize the email content you receive, all email invitations contain a link to access the event.

Depending on your previous experience with Ariba solutions, do one of the following to access the event after you click the link:

- If you are new user, click **Continue** on the welcome page. You continue to register an Ariba account to link with your buyer and participate in the event.
- If you have used Ariba before and have already accessed an event for the buyer-specific account with your current log in ID, click the **Login** button to continue. Log in with your Ariba username and password in order to participate in the event.
- If you already have an existing Ariba Network, Ariba Discovery, or Ariba Sourcing supplier account, but you have not accessed any events for the inviting buyer's site, use the **Click here if you already have an Ariba Commerce Cloud, Ariba Discovery or Ariba Network account** link. After clicking the link, log in with your existing account to move your information to your buyer's site.

Additional Information :- Registering an Ariba account provides you with a consolidated view of all your customer relationships. With this one profile, you can view business opportunities, participate in sourcing events, participate in contract negotiations, and manage orders, catalogs, and invoices.

Why doesn't the link in the email invitation to participate in a sourcing event work?

Answer:-If you cannot click the link, or the link does not open the log in page, highlight and copy the Uniform Resource Locator (URL), and then paste the URL into your web browser.

Can my company have multiple accounts?

Answer:-Your Company can have multiple Ariba accounts, depending on your business needs. For example, if your company has several locations around the world, you might want a separate account for each region.

Most companies choose to have one account with multiple customer relationships, which provides a centralized location to maintain their company profile information and all of their customer relationships.

Additional Information

Consider the following items when deciding whether to have more than one account:

- **Administrators:** For each account, you can have only one account administrator, but the account administrator can provide access to multiple users. All users from your company have their own **Username** and **Password** to access the account.
- **DUNS** (data universal numbering system) **numbers:** You can add your company's DUNS number to only one account. If you plan to have multiple accounts, leave the DUNS number blank during registration.

How do I complete registration if my username already exists?

Answer: - This message means that you already have an Ariba Network, Ariba Discovery, or Ariba Sourcing supplier account registered under username you entered. You can either register a new account by creating a new username, or access one of the following sites to request a password reset for the registered username:

- [Ariba Network](#) (This login page is used for all Ariba Network, Ariba Sourcing, or Ariba Contracts suppliers).
- [Ariba Discovery login page](#)

To reset your password, click the **Having trouble logging in?** Link on the Login page.

Nothing happens when I click Forgot Username and enter my email address

Issue: - Nothing happens when I click the **Forgot Username** link and enter my email address.

Cause: - After you submit your request to retrieve your username, the Ariba Network sends an email notification with usernames that match the email address you submitted.

Some possible reasons why you may not receive this username retrieval email notification:

- The email address on your account does not match the email address you entered when submitting the request.
- Your buyer-specific account was deactivated before you could move it to the Ariba Commerce Cloud. Generally, that means you probably have not participated in an event with that buyer for a while.

Solution: -

- To ensure you receive this email notification:
- Make sure you type the email address configured within your account.

If your buyer-specific account has been deactivated, contact your buyer to determine how to proceed.

Where is my password reset email?

Answer: - After you submit your request for a password reset, Ariba sends instructions to the email address associated with your account. If you didn't receive a password reset email, check the following scenarios to troubleshoot.

The username you entered is in the wrong format, or it isn't associated with the email address you are checking.

- Keep in mind, your username is in the format of a full email address, but it can be associated with any email address you entered previously.
 - Your username is also case-sensitive.
 - To confirm that you are using the correct username and format, return to the Ariba login page, and click the **Having trouble logging in?** link (**Forgot Username** if you're working in Ariba Discovery).
 - Choose **I forgot my username**, and click **Continue**.
 - Enter the email address associated with your account, and click **Submit**.
 - You will receive an email that lists the exact format of the username associated with the email you entered.
-

You entered the correct username, but you still didn't receive the password reset email notification.

- This can occur if the configured email address is different from the account you are checking.
- You might have multiple accounts for your company, so make sure you are attempting to access the correct account.

Your email configuration or company's security settings might also prevent you from receiving the password reset email. To find out, check your junk mail folder or email filter settings to verify that automated emails from Ariba are not blocked from your email account.

 **Why do I get this message on the SAP Ariba Login page: "The username and password pair you entered was not found"?**

Answer: - You entered an incorrect **Username** or **Password**. You might receive this message if you entered a previous **Username** or **Password**. Remember that your **Username** has the format of an email address, and both the **Username** and **Password** are case sensitive.

Click the **Having trouble logging in?** Link on the Login page if you don't remember your log in information.