

Procedure to Participate in Tender

Tender Enquiry No	Work Description	EMD (Rs.) (incl. GST)*	Tender Participation Fee (Rs.) (Incl. GST)**	Last Date and Time for payment of Tender Participation Fee
TPCODL/ P&S/ 1000000738/ 24-25	Open Tender for Supply of GI Earth Coil, GI Earth Pipe	2,00,000/-	5,000/-	11.06.2024, 15.00 Hrs.

* EMD is exempted for MSMEs registered in the State of Odisha.

** MSMEs registered in the State of Odisha shall pay tender fee of Rs. 1,000/- including GST. For details of MSME norms, pls refer "Annexure VII-a"

Please note that corresponding details mentioned in this document will supersede any other details mentioned anywhere else in the Tender Document.

Procedure to Participate in Tender.

Following steps to be done before "Last date and time for Payment of Tender Participation Fee" as mentioned above

1. Eligible and Interested Bidders to submit duly signed and stamped letter on Bidder's letter head indicating
 - a. Tender Enquiry number
 - b. Name of authorized person
 - c. Contact number of authorized person
 - d. e-mail id of authorized person / Ariba online portal ID if any.
 - e. Name of Firm
 - f. Address of Firm
 - g. GST Registration Number
 - h. Details of submission of Tender Participation Fee
 - i. MSME Certificate, wherever applicable
 - j. Details of Bank Account for refund of EMD
 - k. Postal Address for refund of EMD

2. Non-Refundable Tender Participation Fee, as indicated in table above, to be submitted in the form of Direct deposit in the following bank account and submit the receipt along with a covering letter clearly indicating the Tender Reference/ Enquiry Number –

Beneficiary Name – TP Central Odisha Distribution Ltd.

Bank Name – **STATE BANK OF INDIA**

Branch Name – **IDCO Towers, Bhubaneswar**

Address – **PO- Sahidnagar, Janapath, Bhubaneswar.**

Branch Code – 7891 , **Account No – 10835304915** , IFSC Code – SBIN0007891

TP CENTRAL ODISHA DISTRIBUTION LIMITED

(A Joint Venture of Tata Power and Government of Odisha)

Registered Office/Corporate Office: Power House Square, Unit-8, Bhubaneswar, 751012, Tel: 0674-2541575 Web: www.tpcentralodisha.com, E-mail: tpcodl@tpcentralodisha.com, CIN: U40109OR2020 PLC032901

E-mail with necessary attachment of 1 and 2 above to be sent to **Malaya.roul@tpcentralodisha.com** with copy to **sudhakar.behera@tpcentralodisha.com** before last date and time for payment of Tender Participation Fee.

Interested bidders to submit Tender Participation Fee and Authorization Letter before Last date and time as indicated above after which link from TPCODL E-Tender system (Ariba) will be shared for further communication and bid submission.

Please note all future correspondence regarding the tender, bid submission, bid submission date extension, Pre-bid query etc. will happen only through TPCODL E-Tender system (Ariba). User manual to guide the bidders to submit the bid through E-Tender system (Ariba) is also enclosed.

All communication will be done strictly with the bidders who have done the above step to participate in the Tender.

Also it may be strictly noted that once date of “Last date and time for Payment of Tender Participation Fee” is lapsed no Bidder will be sent link from TPCODL E-Tender System (Ariba). Without this link vendor will not be able to participate in the tender. Any last moment request to participate in tender will not be entertained.

Also all future corrigendum's to the said tender will be informed on Tender section on website <https://www.tpcentralodisha.com>.



TP CENTRAL ODISHA
DISTRIBUTION LIMITED

(A Joint Venture of Tata Power and Government of Odisha)

RfX No.: **NA**

NIT No.: TPCODL/P&S/1000000738/2024-25

OPEN TENDER NOTIFICATION

FOR

ONE YEAR RATE CONTRACT OF SUPPLY OF
GI EARTH COIL, GI EARTH PIPE

Tender Enquiry No.: TPCODL/P&S/1000000738/24-25

Due Date for Bid Submission: 21.06.2024 [17:00 Hrs.]

TP Central Odisha Distribution Limited
1st Floor, Anuj Building, Plot No-29, Satya Nagar, Bhubaneswar-
751007.

Corporate office: TP CENTRAL ODISHA DISTRIBUTION LIMITED
(A Joint Venture of Tata Power and Government of Odisha)

Registered Office/Corporate Office: Power House Square, Unit-8, Bhubaneswar, 751012, Tel: 0674-2541575 Web:
www.tpcentralodisha.com, E-mail: tpcodl@tpcentralodisha.com, CIN: U40109OR2020 PLC032901

RFx No.: NA

NIT No.: TPCODL/P&S/100000738/2024-25

CONTENTS OF THE ENQUIRY

S. NO.	PARTICULARS
1.	Event Information
2.	Evaluation Criteria
3.	Submission of Bid Documents
4.	Bid Opening & Evaluation process
5.	Award Decision
6.	Order of Preference/Contradiction
7.	Post Award Contract Administration
8.	Specifications and Standards
9.	General Conditions of Contract
10.	Safety
Annexures	
I.	Annexure I – Schedule of Items
II.	Annexure II – Technical Specifications
III.	Annexure III – Schedule of Deviations
IV.	Annexure IV – Schedule of Commercial Specifications
V.	Annexure V – Document Check List
VI.	Annexure VI – Acceptance Form for Participation in Reverse Auction Event
VII.	Annexure VII – General Condition of Contract
VII(A)	Annexure VII(a) – Preferential Procurement norms for Local MSMEs
VIII	Annexure VIII – Safety Policy and Safety Terms and Conditions
IX.	Annexure IX – Tata Code of Conduct (TCoC)
X.	Annexure X - Environment & Sustainability Policy
XI.	Annexure-XI - Quality, Safety, Occupational Health & Environment
XII.	Annexure-XII – Ariba- E - Auction rules

RFx No.: NA

NIT No.: TPCODL/P&S/100000738/2024-25

1.0 Event Information

1.1 Scope of work

Open Tenders are invited through Ariba online portal e-tender process from interested Bidders for One year Rate contract for supply of following Items as defined below:

S. No.	Description	EMD Amount (Rs.)	Tender Fee Inclusive of GST (Rs.)
1	Rate contract for supply of GI Earthing Coil & Earthing Pipe	2,00,000/-	5000/-

Note:-

1) EMD is exempted for MSME Firms registered in the State of Odisha.

2) MSMEs registered in the State of Odisha shall pay tender fee of Rs. 1,000/- including GST.

1.2 Availability of Tender Documents

Please Refer "Procedure to participate in the e-Tender".

1.3 Calendar of Events

(a)	Date of sale/ availability of tender documents from TPCODL Website	From 04.06.2024 onwards
(b)	Date by which Interested and Eligible Bidder to pay Tender Fee and confirm participation as mentioned in "Procedure to Participate in Tender"	11.06.2024 , 15:00 Hrs
(c)	Date & Time of Pre-Bid Meeting (If any)	12.06.2024 , 12.00 Hrs.
(d)	Last Date and time of receipt of pre-bid queries, if any	13.06.2024 up to 14:00 Hours
(e)	Last Date of Posting Consolidated replies to all the pre-bid queries as received	18.06.2024
(f)	Last date and time of receipt of Bids	21.06.2024 up to 17:00 Hours
(g)	Date & Time of opening technical bids & EMD (Envelope-1 & 2)	Participating Bidders will get mail intimation from TPCODL E-Tender system (Ariba) when their Technical Bids are opened. Refer Section 4.2 for details
(h)	Date & Time of opening of Price of qualified bids	Bidders will get mail intimation from TPCODL E-Tender system (Ariba) when their Price Bids are opened (Refer Section 4.5)

Note :- In the event of last date specified for submission of bids and date of opening of bids is declared as a closed holiday for TPCODL Bhubaneswar office, the last date of submission of bids and date of opening of bids will be the following working day at appointed times.

1.4 Mandatory documents required along with the Bid

Following documents are to be furnished along with the bid to the address as mentioned at clause 3.1.

1.4.1 EMD of requisite value and validity

1.4.2 Tender Fee in case the tender is downloaded from website

RFx No.: NA

NIT No.: TPCODL/P&S/100000738/2024-25

- 1.4.3 Requisite Documents for compliance to Qualification Criteria mentioned in Clause 1.7.
- 1.4.4 Drawing, Type Test details along with a sample of each item as specified at Annexure I (as applicable)
- 1.4.5 Duly signed and stamped 'Schedule of Deviations' as per Annexure III on bidder's letter head.
- 1.4.6 Duly signed and stamped 'Schedule of Commercial Specifications' as per Annexure IV on bidder's letter head.
- 1.4.7 Proper authorization letter/ Power of Attorney to sign the tender on the behalf of bidder.
- 1.4.8 Copy of PAN, GST, PF and ESI Registration (In case any of these documents is not available with the bidder, same to be explicitly mentioned in the 'Schedule of Deviations')

Please note that in absence of any of the above documents, the bid submitted by a bidder shall be liable for rejection.

1.5 Deviation from Tender

Normally, the deviations to tender terms are not admissible and the bids with deviation are liable for rejection. Hence, the bidders are advised to refrain from taking any deviations on this Tender. Still in case of any deviations, all such deviations shall be set out by the Bidders, clause by clause in the 'Annexure III - Schedule of Deviations' and same shall be submitted as a part of the Technical Bid.

1.6 Right of Acceptance/Rejection

Bids are liable for rejection in absence of following documents:-

- 1.6.1 EMD of requisite value and validity
- 1.6.2 Tender fee of requisite value
- 1.6.3 Price Bid as per the Price Schedule mentioned in Annexure-I
- 1.6.4 Necessary documents against compliance to Qualification Requirements mentioned at Clause 1.7 of this Tender Document.
- 1.6.5 Filled in Schedule of Deviations as per Annexure III
- 1.6.6 Filled in Schedule of Commercial Specifications as per Annexure IV
- 1.6.7 Receipt of Bid within the due date and time

TPCODL reserves the right to accept/reject any or all the bids without assigning any reason thereof.

1.7 Qualification Criteria

- a) The bidder should have an average annual turnover of Rs.2.0 crore in last three financial years. Copy of audited Balance Sheet and P&L Account to be submitted in this regard.
- b) Bidder should be Original Equipment Manufacturer (OEM) or authorized dealer/supplier of OEM for which they are submitting their bid. In case of OEM, valid Manufacturing license issued by concerned state/India Govt. for carrying out these works, the copies of such License shall be submitted in this regard. In case of authorized dealer/supplier, Copy of authorization certificate from OEM shall have to submit.
- c) The bidder should have in house testing facility or can facilitate tests through a NABL accredited lab. Supporting document against In House Testing facility shall be submitted. In case of facilitation through NABL accredited laboratory, Undertaking in this regard shall be submitted.

RFx No.: **NA**

NIT No.: TPCODL/P&S/100000738/2024-25

- d) The Bidder shall furnish the type test certificates for the tests as mentioned above as per the corresponding standards. All the tests shall be conducted at CPRI / ERDA / Other Government Labs/ NABL accredited Lab as per relevant IS. Type tests should have been conducted during the period not exceeding 5 years from the date of opening the bid. In the event of any discrepancy in the test reports, i.e. any test report not acceptable, same shall be carried out without any cost implication to TPCODL.
- e) The bidder should have previous supply experience of same / similar items as envisaged in this tender through a single order / multiple orders of a minimum value Rs. 01 Cr. in the last 05 years. Copy of supply order and client certified completion certificate or document evidencing supply of materials should be submitted to establish.
- f) Bidder must have all statutory compliance like valid PAN, MSME cert. (if any), ESI registration, EPF registration, and GSTN registration.

Note :

TPCODL reserves the right to relax qualification criteria without assigning any reason thereof. Also, TPCODL reserve the right to scrutinize and reject any of such existing vendors without assigning reason what so ever may be. In case bidder has previous association with TPCODL for similar products and services, the performance feedback for that bidder by TPCODL's user group shall be considered.

1.8 Marketing Integrity

We have a fair and competitive marketplace. The rules for bidders are outlined in the General Condition of Contracts. Bidders must agree to these rules prior to participating. In addition to other remedies available, TPCODL reserves the right to exclude a bidder from participating in future markets due to the bidder's violation of any of the rules or obligations contained in the General Condition of Contracts. A bidder who violates the market place rules or engages in behaviour that disrupts the fair execution of the marketplace, may result in restriction of a bidder from further participation in the marketplace for a length of time, depending upon the seriousness of the violation. Examples of violations include, but are not limited to:

- Failure to honor prices submitted to the marketplace
- Breach of terms as published in TENDER/NIT

1.9 Supplier Confidentiality

All information contained in this tender is confidential and shall not be disclosed, published or advertised in any manner without written authorization from TPCODL. This includes all bidding information submitted to TPCODL. All tender documents remain the property of TPCODL and all suppliers are required to return these documents to TPCODL upon request. Suppliers who do not honor these confidentiality provisions will be excluded from participating in future bidding events.

2.0 Evaluation Criteria

- The bids will be evaluated technically on the compliance to tender terms and conditions.

RFx No.: **NA**

NIT No.: TPCODL/P&S/100000738/2024-25

- ☑ The bids will be evaluated commercially on **lowest cost in each line item total BOQ Basis as calculated in Schedule of Items [Annexure I] .TPCODL reserves the right to split the Quantity, line item wise. It may split into maximum 02 bidders**, Hence all bidders are advised to quote their most competitive rates.
- ☑ In case of Reverse Auction, if any change arises in overall BOQ price, it shall be applicable proportionately in each line item in the complete tender BOQ.
- ☑ Bidder has to mandatorily quote as per schedule of item [Annexure-I]. Failing to do so TPCODL may reject the bid.

NOTE:

In case of a new bidder not registered, inspection of Testing house and evaluation shall be carried out to ascertain bidder's capability and quality procedures. However TPCODL reserves the right to carry out inspection and evaluation for any bidder prior to technical qualification. In case a bidder is found as Disqualified in the evaluation, their bid shall not be evaluated any further and shall be summarily rejected. The decision of TPCODL shall be final and binding on the bidder in this regard.

2.1

Price Variation Clause: The prices shall remain **FIRM** during the entire contract period.

3.0 Submission of Bid Documents

3.1 Bid Submission

Bidders are requested to submit their offer in line with this Tender document through e-tendering process. Please note all future correspondence regarding the tender, bid submission, bid submission date extension, Pre-bid query etc will happen only through TPCODL E-Tender system (Ariba).

No verbal correspondence will be responded. All communication will be done strictly with the bidder who have done the above step to participate in the Tender.

Bids shall be submitted in 3 (Three) parts:

- **FIRST PART: "EMD"** as applicable shall be submitted. The EMD shall be valid for 210 days from the

due date of bid submission in the form of Bank Guarantee / Bank Draft / Bankers Pay Order (issued from a Scheduled Bank) favoring 'TP Central Odisha Distribution Limited' payable at Bhubaneswar. The EMD (BG) has to be strictly in the format as mentioned in General Condition of Contract, failing which it shall not be accepted and the bid as submitted shall be liable for rejection. A separate non refundable tender fee of stipulated amount also needs to be transferred online through NEFT/ RTGS in case the tender document is downloaded from our website.

TPCODL/ TPCODL Bank Details for transferring Tender Fee and EMD is as below:

Account Name: TP Central Odisha Distribution Limited

Bank Name: SBI, IDCO Towers, Bhubaneswar

Bank Account No. : 10835304915

IFSC Code : SBIN0007891

EMD is strictly preferred in form of Bank Guarantee and to be delivered at the following address. However in view of present situation if Bidder is finding it difficult to make and submit BG for EMD

RFx No.: **NA**

NIT No.: TPCODL/P&S/100000738/2024-25

amount, they can do online transfer of EMD amount in the above mentioned Account and submit proof of the same as part of Bid Submission.

Please note that in such case, Tender Fee and EMD should be strictly 2 separate transactions.

Please note as return of EMD from Bank Account is non standard practice the same may take more time than return of EMD BG.

EMD Original Hard Copy shall be delivered at the following address in Envelope clearly indicating Tender Reference/ Enquiry Number, Name of Tender and Bidder Name

Chief (Procurement & Stores)

TP CENTRAL ODISHA DISTRIBUTION LIMITED

1st floor, Anuj building, Plot No. 29, Satya Nagar, Bhubaneswar, Odisha – 751007

➤ **SECOND PART: “TECHNICAL BID”** shall contain the following documents:

- a) Documentary evidence in support of qualifying criteria
- b) Technical literature/GTP/Type test report etc. *(if applicable)*
- c) Qualified manpower (if available)
- d) Testing facilities *(if applicable)*
- e) No Deviation Certificate as per the Annexure III – Schedule of Deviations
- f) Acceptance to Commercial Terms and Conditions viz Delivery schedule/period, payment terms etc. as per the Annexure IV – Schedule of Commercial Specifications.
- g) Quality Assurance Plan/Inspection Test Plan for supply items *(if applicable)*

The technical bid shall be properly indexed and is to be submitted through TPCODL E-tender System (Ariba) only. Hard Copy of Technical Bids need not be submitted.

The Bid prepared by the Bidder, and all correspondence and documents relating to the Bid exchanged by the Bidder and the TPCODL, shall be written in the English Language. Any printed literature furnished by the Bidder may be written in another Language, provided that this literature is accompanied by an English translation, in which case, for purposes of interpretation of the Bid, the English translation shall govern

➤ **THIRD PART: “PRICE BID”** shall contain only the price details and strictly in format as mentioned in Annexure I (separate Price Bid for Lot-A & Lot-B shall be submitted) with explicit break up of basic prices, Taxes & duties, Freight etc. In case any discrepancy is observed between the item description stated in Schedule of Items mentioned in the tender and the price bid submitted by the bidder, the item description as mentioned in the tender document (to the extent modified through Corrigendum issued if any) shall prevail. Price Bid is to be submitted in soft copy through TPCODL E-Tendering system (Ariba) only. **Hard copy of Price Bid not be submitted.**

SIGNING OF BID DOCUMENTS:

The bid must contain the name, residence and place of business of the person or persons making the bid and must be signed and sealed by the Bidder with his usual signature. The names of all persons signing should also be typed or printed below the signature.

The Bid being submitted must be signed by a person holding a Power of Attorney authorizing him to do so, certified copies of which shall be enclosed.

The Bid submitted on behalf of companies registered with the Indian Companies Act, for the time being in force, shall be signed by persons duly authorized to submit the Bid on behalf of the Company and shall be accompanied by certified true copies of the resolutions, extracts of Articles of Association,

RFx No.: NA

NIT No.: TPCODL/P&S/100000738/2024-25

special or general Power of Attorney etc. to show clearly the title, authority and designation of persons signing the Bid on behalf of the Company. Satisfactory evidence of authority of the person signing on behalf of the Bidder shall be furnished with the bid.

A bid by a person who affixes to his signature the word 'President', 'Managing Director', 'Secretary', 'Agent' or other designation without disclosing his principal will be rejected.

The Bidder's name stated on the Proposal shall be the exact legal name of the firm.

3.2 Contact Information

Please note all correspondence regarding the tender, bid submission, bid submission date extension, Pre-bid query etc will happen only through TPCODL E-Tender system (Ariba).

No verbal correspondence will be responded. All communication will be done strictly with the bidder who have done the above step to participate in the Tender. **Communication Details:**

Handling Executive :

Head : Engineering

Name: Mr. Malaya Ranjan Roul

Name: Khajan Bharadwaj

Contact No.: 8763216613

Contact No: 7836810510

E-Mail ID: Malaya.roul@tpcentralodisha.com Email: Khajan.Bharadwaj@tpcentralodisha.com

Sr. General Manager (Purchase & Stores)

Team Lead : Engineering

Name: Sri Sudhakar Behera

Name:

Contact No.: 9437282663

contact:

E-Mail ID: Sudhakar.behera@tpcentralodisha.com mail:

Bidders are strictly advised to communicate with Package Owner through TPCODL E-tender System (Ariba) only. They need to pay Tender Participation Fee and receive the Ariba log-in. Above escalation details are for reference purpose only.

3.3 Bid Prices

Bidders shall quote for the entire Scope of Supply/ work with a break up of prices for individual items and Taxes & duties. The bidder shall complete the appropriate Price Schedules included herein, stating the Unit Price for each item & total price with taxes, duties & freight up to destination at various sites of TPCODL. The all-inclusive prices offered shall be inclusive of all costs as well as Duties, Taxes and Levies paid or payable during the execution of the supply work, breakup of price constituents.

Applicable GST to be specified clearly.

The quantity break up shown else-where other than Price Schedule is tentative. The bidder shall ascertain himself regarding material required for completeness of the entire work. Any items not indicated in the price schedule but which are required to complete the job as per the Technical Specifications/ Scope of Work/ SLA mentioned in the tender, shall be deemed to be included in prices quoted.

3.4 Bid Currencies

Prices shall be quoted in Indian Rupees Only.

3.5 Period of Validity of Bids

Bids shall remain valid for 180 days from the due date of submission of the bid.

RFx No.: NA

NIT No.: TPCODL/P&S/100000738/2024-25

Notwithstanding clause above, the TPCODL may solicit the Bidder's consent to an extension of the Period of Bid Validity. The request and responses thereto shall be made in writing.

3.6 Alternative Bids

Bidders shall submit Bids, which comply with the Bidding documents. Alternative bids will not be considered. The attention of Bidders is drawn to the provisions regarding the rejection of Bids in the terms and conditions, which are not substantially responsive to the requirements of the bidding documents.

3.7 Modifications and Withdrawal of Bids

The bidder is not allowed to modify or withdraw its bid after the Bid's submission. The EMD as submitted along with the bid shall be liable for forfeiture in such event.

3.8 Earnest Money Deposit (EMD))-

The bidder shall furnish, as part of its bid, an EMD amounting as specified in the tender. The EMD is required to protect the TPCODL against the risk of bidder's conduct which would warrant forfeiture.

The EMD shall be denominate in any of the following form:

- Banker's Cheque/ Demand Draft/ Pay order drawn in favour of TPCODL, payable at Bhubaneswar.
- Online transfer of requisite amount through NEFT/ RTGS.
- Bank Guarantee valid for 210 days after due date of submission.

The EMD shall be forfeited in case of:

a) The bidder withdraws its bid during the period of specified bid validity.

Or

- b) The case of a successful bidder, if the Bidder does not
- i) accept the purchase order, or
 - ii) furnish the required performance security BG

3.9 Type Tests (if applicable)

The type tests specified in TPCODL specifications should have been carried out within five years prior to the date of opening of technical bids and test reports are to be submitted along with the bids. If type tests carried out are not within the five years prior to the date of bidding, the bidder will arrange to carry out type tests specified, at his cost. The decision to accept/ reject such bids rests with TPCODL.

4.0 Bid Opening & Evaluation process

4.1 Process to be confidential

Information relating to the examination, clarification, evaluation and comparison of Bids and recommendations for the award of a contract shall not be disclosed to Bidders or any other persons not officially concerned with such process. Any effort by a Bidder to influence the TPCODL's processing of Bids or award decisions may result in the rejection of the Bidder's Bid.

4.2 Technical Bid Opening

The bids shall be opened at TPCODL office in front of participated bidders either physically or in virtual mode . A link shall be provided to the participated bidders to view the tender opening process online. Also Participating Bidders shall get mail intimation from TPCODL E-Tender system (Ariba) when their Technical Bids are opened.

RFx No.: NA**NIT No.: TPCODL/P&S/100000738/2024-25**

First the envelope marked “EMD” will be opened. Bids without EMD/ cost of tender (if applicable) of required amount/ validity in prescribed format, shall be rejected.

4.3 Preliminary Examination of Bids/Responsiveness

TPCODL will examine the Bids to determine whether they are complete, whether any computational errors have been made, whether required sureties have been furnished, whether the documents have been properly signed, and whether the Bids are generally in order. TPCODL may ask for submission of original documents in order to verify the documents submitted in support of qualification criteria.

Arithmetical errors will be rectified on the following basis: If there is a discrepancy between the unit price and the total price per item that is obtained by multiplying the unit price and quantity, the unit price shall prevail and the total price per item will be corrected. If there is a discrepancy between the Total Amount and the sum of the total price per item, the sum of the total price per item shall prevail and the Total Amount will be corrected.

Prior to the detailed evaluation, TPCODL will determine the substantial responsiveness of each Bid to the Bidding Documents including production capability and acceptable quality of the Goods offered. A substantially responsive Bid is one, which conforms to all the terms and conditions of the Bidding Documents without material deviation.

Bid determined as not substantially responsive will be rejected by the TPCODL and may not subsequently be made responsive by the Bidder by correction of the non-conformity.

4.4 Techno Commercial Clarifications

Bidders need to ensure that the bids submitted by them are complete in all respects. To assist in the examination, evaluation and comparison of Bids, TPCODL may, at its discretion, ask the Bidder for a clarification on its Bid for any deviations with respect to the TPCODL specifications and attempt will be made to bring all bids on a common footing. All responses to requests for clarification shall be in writing and no change in the price or substance of the Bid shall be sought, offered or permitted owing to any clarifications sought by TPCODL.

4.5 Price Bid Opening

Price bid of only Techno-commercially and / or safety qualified Bidders shall be opened internally. Bidders shall get mail intimation from TPCODL E-Tender system (Ariba) when their Price Bids are opened.

The EMD of the bidder withdrawing or substantially altering his offer at any stage after the technical bid opening will be forfeited at the sole discretion of TPCODL without any further correspondence in this regard.

4.7 Reverse Auctions

TPCODL shall conduct the reverse auction for the products/ services being asked for in this tender. The terms and conditions for such reverse auction events shall be as per the Acceptance Form attached as Annexure VI of this document. The bidders along with the tender document shall mandatorily submit a duly signed copy of the Acceptance Form attached as Annexure VI as a token of acceptance for the same.

Reverse Auction shall be as per the below approach:

RFx No.: NA**NIT No.: TPCODL/P&S/100000738/2024-25**

No of bidders to be allowed in RA process shall be : Total No of bidders on whom tender would be split PLUS 2 more bidders .

Illustrative example: Total no of qualified bidders is 10 & tender needs to split amongst 4 bidders.

PLUS 2 means (04 + 02 = 06) means lowest 6 bidders i.e., L1 to L6 bidders would be allowed in the RA process. Balance, H1 to H4 bidders would not be allowed in the RA process.

In case – Total no of qualified bidders is equal to or less than the PLUS 2 number, all qualified bidders shall be allowed in the RA process.

Illustrative example: Total no of qualified bidders is 4 & tender needs to split amongst 2 bidders. PLUS 2 means (02 + 02 = 04), so all 4 qualified bidders would be allowed in the RA process .

Illustrative example: Total no of qualified bidders is 3 & tender would be awarded to single party only. PLUS 2 means (01 + 02 = 03), so all 3 qualified bidders would be allowed in the RA process

5.0 Award Decision

TPCODL will award the contract to the successful bidder whose bid has been determined to be the lowest-evaluated responsive bid as per the Evaluation Criterion mentioned at Clause 2.0. The Cost for the said calculation shall be taken as the all-inclusive cost quoted by bidder in Annexure I (Schedule of Items) subject to any corrections required in line with Clause 4.3 above. The decision to place purchase order/LOI solely depends on TPCODL on the cost competitiveness across multiple lots, quality, delivery and bidder's capacity, in addition to other factors that TPCODL may deem relevant.

TPCODL reserves all the rights to award the contract to one or more bidders so as to meet the delivery requirement or nullify the award decision without assigning any reason thereof.

In case any supplier is found unsatisfactory during the delivery process, the award will be cancelled and TPCODL reserves the right to award other suppliers who are found fit.

6.0 Order of Preference/Contradiction:

In case of contradiction in any part of various documents in tender, following shall prevail in order of preference:

1. Schedule of Items (Annexure I)
2. Post Award Contract Administration (Clause 7.0)
3. Submission of Bid Documents (Clause 3.0)
4. Scope of Work and SLA (if any)
5. Technical Specifications (Annexure II)
6. Inspection Test Plan (if any)
7. Acceptance Form for Participation in Reverse Auction (Annexure VI)
8. General Conditions of Contract (Annexure VII)

7.0 Post Award Contract Administration

7.1 Special Conditions of Contract

- After finalization of tender, Rate Contract shall be issued on successful bidder with a validity period of **One Year**. Prices shall remain firm till validity of issued rate contract. Within the validity of rate contract and as per requirement of material, release order shall be issued time to time.
- Business Associate (BA) shall submit applicable **Performance Bank Guarantee** as per GCC within 30 days of issuance of rate contract. PBG applicable shall 5% of whole Rate Contract Value or 10% of

RFx No.: NA

NIT No.: TPCODL/P&S/100000738/2024-25

Release Order value. BA can submit PBG against each Release Order. PBG submitted, shall be released after completion of applicable guarantee period plus one month.

- **Guarantee** applicable shall be as per technical specifications.
- BA shall submit GTP/ Drawing within 07 days from issuance of rate contract. If drawing is not approved by competent authority due to document shortfall or any changes are suggested, vendor has to re-submit new drawing/GTP/documents within 05 days of such intimation. BA shall offer for prototype inspection within 15 days of issuance of approved Drawings/GTP. In case BA does not get necessary approvals for issuance of manufacturing clearances /CAT-A within mentioned /mutually agreed timelines, then CCG-TPCODL/other TP Odisha Discoms reserve the right to cancel issued rate contract / release order and also reserve the right to forfeit EMD/PBG.
- **Delivery period** shall be 60 days from date of receipt of release order / CAT-A issuance, whichever is later.
- TPCODL shall short close the issued Release Order / Rate contract, in case of any quality issues.
- Any change in statutory taxes, duties and levies shall be borne by TPCODL.
- All other terms and conditions of TPCODL GCC shall be applicable.

7.2 Drawing Submission & Approval

The relevant Survey , drawings and GTPs need to be submitted within one weeks of receipt of rate contract by the successful bidder to TPCODL for approval. In case, re-submission of drawings is required on request of TPCODL, same needs to be submitted back to TPCODL within 5 days of such request.

7.3 Delivery Terms

- The delivery schedule shall be **60 days** from the date of issuing of PO/RO issued by MRP Team / CAT-A issuance, whichever is later.

7.4 Guarantee/Warranty Period

Bidder shall stand guarantee towards design, materials, workmanship & quality of process / manufacturing of items under this contract for due and intended performance of the same, as an integrated product delivered under this contract. In the event any defect is found by the Purchaser up to a period mention in individual specification from the date of commissioning or months from the date of last supplies made under the contract whichever is earlier, Bidder shall be liable to undertake to replace/rectify such defects at its own costs, within mutually agreed time frame, and to the entire satisfaction of the Purchaser, failing which the Purchaser will be at liberty to get it replaced/rectified at Bidder's risks and costs and recover all such expenses plus the Purchaser's own charges (@ 20% of expenses incurred), from the Bidder or from the "Security cum Performance Deposit" as the case may be. Bidder shall further be responsible for 'free replacement' for another period of THREE years from the end of the guarantee period for any 'Latent Defects' if noticed and reported by the Purchaser..

7.5 Payment Terms

On successful completion of SITC work in good condition and certification of acceptance by certified official, Associate shall submit the Bills/ Invoices in original in the name of TP Central Odisha Distribution Limited to Invoice Desk. **100% payment shall be released within 30 days from the date of submission of error free certified bills/ invoices.**

7.6 Climate Change

RFx No.: NA

NIT No.: TPCODL/P&S/100000738/2024-25

Significant quantities of waste are generated during the execution of project and an integrated approach for effective handling, storage, transportation and disposal of the same shall be adopted. This would ensure the minimization of environmental and social impact in order to combat the climate change.

7.7 Ethics

TPCODL is an ethical organization and as a policy TPCODL lays emphasis on ethical practices across its entire domain. Bidder should ensure that they should abide by all the ethical norms and in no form either directly or indirectly be involved in unethical practice.

TPCODL work practices are governed by the Tata Code of Conduct which emphasizes on the following:

- We shall select our suppliers and service providers fairly and transparently.
- We seek to work with suppliers and service providers who can demonstrate that they share similar values. We expect them to adopt ethical standards comparable to our own.
- Our suppliers and service providers shall represent our company only with duly authorized written permission from our company. They are expected to abide by the Code in their interactions with, and on behalf of us, including respecting the confidentiality of information shared with them.
- We shall ensure that any gifts or hospitality received from, or given to, our suppliers or service providers comply with our company's gifts and hospitality policy.
- We respect our obligations on the use of third party intellectual property and data.

Bidder is advised to refer GCC attached at Annexure VII for more information.

Any ethical concerns with respect to this tender can be reported to the following e-mail ID: ethics@tpcentralodisha.com

8.0 Specification and standards

Attached separately with the tender As per Annexure II.

9.0 General Condition of Contract

Any condition not mentioned above shall be applicable as per GCC for Supply attached along with this tender at Annexure VII.

10.0 Safety : Safety related requirements as mentioned in our safety Manual put in the Company's website which can be accessed by: <http://www.tpcentralodisha.com>. All Associates shall strictly abide by the guidelines provided in the safety manual at all relevant stages during the contract period.

RFx No.: NA

NIT No.: TPCODL/P&S/100000738/2024-25

ANNEXURE I

Schedule for Items

Sl. No.	Item Description	HSN/ SAC code	Qty.	UoM.	Unit Price (Rs.)	GST (Rs.)	All incl. Unit landed Price (Rs.)	All incl. BOQ Price (Rs.)
1	2	3	4	5	6	7	8=6+7	9=8x4
1	GI EARTHING PIPE 40MM DIA , 3M LENGTH		13,000	EA				
2	GI EARTHING PIPE 100 MM DIA, 3M LENGTH		300	EA				
3	COIL EARTHING.		17,000	EA				
	TOTAL (RS.)							

NOTE:

- The quantity mentioned above is for evaluation purpose only and may vary during the execution. Release Orders against this Rate Contract shall be issued by TPCODL as per actual requirement.
- The bidders are advised to quote prices strictly in the above format and for all the line items as mentioned above. Failing to do so, bids are liable for rejection.
- Unit price (column 6) in the table above shall be inclusive of ex-works price, Transit Insurance, transport charges , loading, unloading and all other handling charges to the TPCODL Stores of Cuttack / Bhubaneswar. Delivery address of each store will be mentioned in respective ROs.
- The bidders are advised to quote prices strictly in the above format. Failing to do so, bids are liable for rejection.
- The bidder must fill each and every column of the above format. Mentioning “extra/inclusive” in any of the column may lead for rejection of the price bid.
- No cutting/ overwriting in the prices is permissible.
- All line item prices shall remain firm and fixed for one year for placement of ROs.

Rfx No.: **NA**

NIT No.: TPCODL/P&S/100000738/2024-25

ANNEXURE II

Technical Specifications

Attached separately

CONFIDENTIAL

RFx No.: **NA**

NIT No.: TPCODL/P&S/100000738/2024-25

ANNEXURE III**Schedule of Deviations**

Bidders are advised to refrain from taking any deviations on this TENDER. Still in case of any deviations, all such deviations from this tender document shall be set out by the Bidders, Clause by Clause in this schedule and submit the same as a part of the **Technical Bid**.

Unless **specifically** mentioned in this schedule, the tender shall be deemed to confirm the TPCODL's specifications:

S. No.	Clause No.	Tender Clause Details	Details of deviation with justifications

By signing this document we hereby withdraw all the deviations whatsoever taken anywhere in this bid document and comply to all the terms and conditions, technical specifications, scope of work etc. as mentioned in the standard document except those as mentioned above.

Seal of the Bidder:

Signature:

Name:

RFx No.: NA

NIT No.: TPCODL/P&S/1000000738/2024-25

ANNEXURE IV

Schedule of Commercial Specifications

(The bidders shall mandatorily fill in this schedule and enclose it with the offer Part I: Technical Bid. In the absence of all these details, the offer may not be acceptable.)

S. No.	Particulars	Remarks
1.	Prices firm or subject to variation (If variable indicate the price variation clause with the ceiling if applicable)	Firm / Variable
1a.	If variable price variation on clause given	Yes / No
1b.	Ceiling	----- %
1c.	Inclusive of Excise Duty	Yes / No (If Yes, indicate % rate)
1d.	Sales tax applicable at concessional rate	Yes / No (If Yes, indicate % rate)
1e.	Octroi payable extra	Yes / No (If Yes, indicate % rate)
1f.	Inclusive of transit insurance	Yes / No
2.	Delivery	Weeks / months
3.	Guarantee clause acceptable	Yes / No
4.	Terms of payment acceptable	Yes / No
5.	Performance Bank Guarantee acceptable	Yes / No
6.	Liquidated damages clause acceptable	Yes / No
7.	Validity (90 days) (From the date of opening of technical bid)	Yes / No
8.	Inspection during stage of manufacture	Yes / No
9.	Rebate for increased quantity	Yes / No (If Yes, indicate value)
10.	Change in price for reduced quantity	Yes / No (If Yes, indicate value)
11.	Covered under Small Scale and Ancillary Industrial Undertaking Act 1992	Yes / No (If Yes, indicate, SSI Reg'n No.)

RFx No.: NA

NIT No.: TPCODL/P&S/100000738/2024-25

ANNEXURE V**Checklist of all the documents to be submitted with the Bid**

Bidder has to mandatorily fill in the checklist mentioned below:-

S. No.	Documents attached	Yes / No / Not Applicable
1	EMD of required value	
2	Tender Fee as mentioned in this RFQ	
3	Company profile/organ gram	
4	Signed copy of this RFQ as an unconditional acceptance	
5	Duly filled schedule of commercial specifications (Annexure IV)	
6	Sheet of commercial/technical deviation if any (Annexure III)	
7	Balance sheet for the last completed three financial years; mandatorily enclosing Profit & loss account statement	
8	Acknowledgement for Testing facilities if available (duly mentioned on bidder letter head)	
9	List of Machine/tools with updated calibration certificates if applicable	
10	Details of order copy (duly mentioned on bidder letter head)	
11	Order copies as a proof of quantity executed	
12	Details of Type Tests if applicable (duly mentioned on bidder letter head)	
13	All the relevant Type test certificates as per relevant IS/IEC (CPRI/ERDA/other certified agency) if applicable	
14	Project/supply Completion certificates	
15	Performance certificates	
16	Client Testimonial/Performance Certificates	
17	Credit rating/solvency certificate	
18	Undertaking regarding non blacklisting (On company letter head)	
19	List of trained/untrained Manpower	

ANNEXURE VI

Acceptance Form for Participation In Reverse Auction Event

(To be signed and stamped by the bidder)

In a bid to make our entire procurement process more fair and transparent, TPCODL intends to use the reverse auctions through SAP-SRM tool as an integral part of the entire tendering process. All the bidders who are found as technically qualified based on the tender requirements shall be eligible to participate in the reverse auction event.

The following terms and conditions are deemed as accepted by the bidder on participation in the bid event:

1. TPCODL shall provide the user id and password to the authorized representative of the bidder. *(Authorization Letter in lieu of the same shall be submitted along with the signed and stamped Acceptance Form).*
2. TPCODL will make every effort to make the bid process transparent. However, the award decision by TPCODL would be final and binding on the supplier.
3. The bidder agrees to non-disclosure of trade information regarding the purchase, identity of TPCODL, bid process, bid technology, bid documentation and bid details.
4. The bidder is advised to understand the auto bid process to safeguard themselves against any possibility of non-participation in the auction event.
5. In case of bidding through Internet medium, bidders are further advised to ensure availability of the entire infrastructure as required at their end to participate in the auction event. Inability to bid due to telephone line glitch, internet response issues, software or hardware hangs, power failure or any other reason shall not be the responsibility of TPCODL.
6. In case of intranet medium, TPCODL shall provide the infrastructure to bidders. Further, TPCODL has sole discretion to extend or restart the auction event in case of any glitches in infrastructure observed which has restricted the bidders to submit the bids to ensure fair & transparent competitive bidding. In case of an auction event is restarted, the best bid as already available in the system shall become the start price for the new auction.
7. In case the bidder fails to participate in the auction event due any reason whatsoever, it shall be presumed that the bidder has no further discounts to offer and the initial bid as submitted by the bidder as a part of the tender shall be considered as the bidder's final no regret offer. Any offline price bids received from a bidder in lieu of non-participation in the auction event shall be out-rightly rejected by TPCODL.
8. The bidder shall be prepared with competitive price quotes on the day of the bidding event.
9. The prices as quoted by the bidder during the auction event shall be inclusive of all the applicable taxes, duties and levies and shall be FOR at TPCODL site.
10. The prices submitted by a bidder during the auction event shall be binding on the bidder.
11. No requests for time extension of the auction event shall be considered by TPCODL.
12. The original price bids of the bidders shall be reduced on pro-rata basis against each line item based on the final all inclusive prices offered during conclusion of the auction event for arriving at Contract amount.

Signature & Seal of the Bidder

RfX No.: **NA**

NIT No.: TPCODL/P&S/100000738/2024-25

ANNEXURE VII

**General Conditions of Contract –
Attached separately with the tender**

CONFIDENTIAL

ANNEXURE-VII (A)

Preferential norms for procurement from Local MSMEs

1) Tender Fees

To participate in the tender, MSMEs registered in the State of Odisha shall pay Rs.1,000/- including GST towards cost of tender paper. In Limited Tender no EMD shall applicable.

2) Earnest Money Deposit (EMD)

EMD shall be exempted for MSME registered in the State of Odisha. However, Bidder shall be barred to participate in the tendering process for a period of 2 years in case it backs out post award of the contract.

3) Qualification Requirement for Open Tenders

Qualification Requirement of Financial Turnover for MSME registered in the State of Odisha shall be reduced to 20% of the existing criteria.

For past experience, instead of relying on the volumes / value of earlier Supplies / Projects, assessment of the Bidder shall be done on the basis of feedback from Customers. Past performance experience at Tata Power and its Group Companies shall supersede feedback from other Customers.

4) Reservation for MSME

It shall be mandatory to procure at least 20% of the total volume of the procurement from MSME registered in the State of Odisha (however, it shall not apply where goods/services are not available with the MSME), subject to matching L1 discovered prices and meeting technical specifications including quality requirements.

5) Performance Bank Guarantees

Performance Bank Guarantee for MSME registered in the State of Odisha shall be 25% of the value normally prescribed.

ANNEXURE VIII

**Safety Policy and Safety Terms and Conditions –
Attached separately with the tender.**

CONFIDENTIAL

ANNEXURE IX

Tata Code of Conduct (TCoC) – Attached separately with the tender.

The Owner abides by the Tata Code of Conduct in all its dealing with stake holders and the same shall be binding on the Owner and the Contractor for dealings under this Order/ Contract. A copy of the Tata Code of Conduct is available a tour website:

<https://www.tatapower.com/pdf/aboutus/Tata-Code-of-Conduct.pdf>

The Contractor is requested to bring any concerns regarding this to the notice of our Chief Procurement & Stores mail ID: Pradip.sil@tpcentralodisha.com .

ANNEXURE X
Environment & Sustainability

CONFIDENTIAL



CORPORATE ENVIRONMENT POLICY

Tata Power is committed to a clean, safe and healthy environment, and we shall operate our facilities in an environmentally sensitive and responsible manner. Our commitment to environmental protection and stewardship will be achieved by:

- Complying with the requirements and spirit of applicable environmental laws and striving to exceed required levels of compliance wherever feasible
- Ensuring that our employees are trained to acquire the necessary skills to meet environmental standards
- Conserving natural resources by improving efficiency and reducing wastage
- Making business decisions that aim towards sustainable development
- Engaging with stakeholders to create awareness on sustainability

(Praveer Sinha)
CEO & Managing Director

Date: 15th June, 2018





CORPORATE SUSTAINABILITY POLICY

At Tata Power, our Sustainability Policy integrates economic progress, social responsibility and environmental concerns with the objective of improving quality of life. We believe in integrating our business values and operations to meet the expectations of our customers, employees, partners, investors, communities and public at large

- We will uphold the values of honesty, partnership and fairness in our relationship with stakeholders
- We shall provide and maintain a clean, healthy and safe working environment for employees, customers, partners and the community
- We will strive to consistently enhance our value proposition to the customers and adhere to our promised standards of service delivery
- We will respect the universal declaration of human rights, International Labour Organization's fundamental conventions on core labour standards and operate as an equal opportunities employer
- We shall encourage and support our partners to adopt responsible business policies, Business Ethics and our Code of Conduct Standards
- We will continue to serve our communities:
 - By implementing sustainable Community Development Programmes including through public/private partnerships in and around our area of operations
 - By constantly protecting ecology, maintaining and renewing bio-diversity and wherever necessary conserving and protecting wild life, particularly endangered species
 - By encouraging our employees to serve communities by volunteering and by sharing their skills and expertise
 - By striving to deploy sustainable technologies and processes in all our operations and use scarce natural resources efficiently in our facilities
 - We will also help communities that are affected by natural calamities or untoward incidence, or that are physically challenged in line with the Tata Group's efforts

The management will commit all the necessary resources required to meet the goals of Corporate Sustainability.

(Praveer Sinha)
CEO & Managing Director

Date: 15th June, 2018



ANNEXURE-XI

Quality, Safety, Occupational Health & Environment



Integrated Management System Policy

Quality, Safety, Occupational Health, Environment

We at TP Central Odisha Distribution Limited are committed to deliver world class service and reliable power through an energised workforce leading to ever increasing satisfaction of its customers, environmental protection and safe and healthy working condition.

This will be achieved by:

- Complying with all the requirements of ISO-9001, ISO-14001 and ISO-45001 management system standards through engaged workforce
- Complying with applicable Legal requirements
- Continually improving Quality, Environment and Occupational Health & Safety Performance
- Ensuring Environmental protection through Prevention of Pollution
- Conservation of Natural Resources
- Creating a work environment which encourages team work, safe work practices, learning and innovation
- Providing safe and healthy conditions that prevents work related injury and illness
- Eliminating hazards and reducing OH&S Risk
- Ensuring participation and consultation of workers

This policy will be made available to interested parties.

Date: 1st June, 2023

Arvind Singh
Chief Executive Officer

Rfx No.: **NA**

NIT No.: TPCODL/P&S/100000738/2024-25

ANNEXURE-XII

Ariba e – Auction Rules

Attached separately

CONFIDENTIAL

STANDARD TECHNICAL SPECIFICATION COVER SHEET

Specification No. : ENG-HV-2036

Specification Name : Specification for GI Coil Earthing

Prepared by	Reviewed by	Reviewed by	Reviewed by	Approved by	Released by
Syed Mohammed Yousuf Raja	SATYA PRASAD NAYAK	JYOTIPRAKASH MOHANTY	SHANTAPRIYA JENA	Shailendra Kumar Jaiswal	SHIRISH SHARAD DIKAY
TPSODL	TPCODL	TPWODL	TPNODL	TPSODL	TPSODL
03-03-2023	17-03-2023	27-03-2023	28-03-2023	29-03-2023	29-03-2023

Property of TATA POWER ODISHA DISCOMs – Not to be reproduced without permission of TPCODL/ TPNODL/ TPSODL/ TPWODL



Document No: ENG-HV-2036

Document Title: Specification GI Coil Earthing

CONTENTS

1. SCOPE
2. APPLICABLE STANDARDS
3. CLIMATIC CONDITIONS OF THE INSTALLATION
4. GENERAL CONSTRUCTIONS
5. GENERAL TECHNICAL REQUIREMENTS
6. MARKING
7. TESTS
8. TYPE TEST CERTIFICATES
9. PRE-DESPATCH INSPECTION
10. INSPECTION AFTER RECEIPT AT STORES
11. GUARANTEE
12. PACKING
13. TENDER SAMPLE
14. QUALITY CONTROL
15. MINIMUM TESTING FACILITIES
16. MANUFACTURING ACTIVITIES
17. SPARES, ACCESSORIES AND TOOLS
18. DRAWINGS
19. SCHEDULE OF DEVIATIONS

Initiator		HOG (Plant Engineering)	
-----------	--	--------------------------	--

1.0 SCOPE

The scope of this document is to give design & constructional features, inspection, supply and transportation guidelines for GI Coil Earthing for TPCODL/TPNODL/TPWODL/TPSODL.

2.0 APPLICABLE STANDARDS

The equipment covered by this specification shall unless otherwise stated, be designed, manufactured and tested in accordance with latest editions of the following standards/IEC and shall conform to the regulations of local statutory authorities.

- a) IS: 280 - Mild steel wire for general engineering purposes.
- b) IS: 4826 - Specification for hot-dipped galvanized coatings on round steel wires.
- c) IS: 7887 - Mild steel wire rods for general engineering purposes.
- d) IS: 2629 - Recommended practice for hot-dip galvanizing of iron and steel
- e) IS: 1521 - Method for tensile testing for steel wires
- f) IS: 1755 - Method for wrapping testing for wire
- g) IS: 6745 - Methods for determination of mass of zinc coating on zinc coated iron and steel

3.0 CLIMATIC CONDITIONS:

1	Maximum ambient temperature	50 deg C
2	Max. Daily average ambient temp	35 deg C
3	Min Ambient Temperature	0 deg C
4	Maximum Humidity	95%
5	Average Annual Rainfall	1500 mm
6	Average No. of rainy days per annum	120
7	Altitude above MSL not exceeding	1000m
8	Wind Speed	300 Km/hr
9	Earthquakes of an intensity in horizontal direction	equivalent to seismic acceleration of 0.3g
10	Earthquakes of an intensity in vertical direction	equivalent to seismic acceleration of 0.15g (g being acceleration due to gravity)

TPCODL/TPNODL/TPSODL/TPWODL service area has heavy saline conditions along the coast and High cyclonic Intensity winds with speed upto 300 Kmph. The atmosphere is generally laden with mild acid and dust in suspension during the dry months and is subjected to fog in cold months.

4.0 GENERAL CONSTRUCTION:

The material shall be-

- a) Heavy class as per IS- 1239/IS 1161-1979.
- b) Galvanizing to be done after fabrication as per IS: 4826
- c) The design shall be suitable for the climatic condition stated above.
- d) Tolerance in Dimensions & Weight should be $\pm 2.5\%$ unless otherwise specified
- e) Dimensional tolerance shall be as per IS 1852-1985
- f) Zinc electroplated/painted material will not be accepted, should be properly galvanized.
- g) No Rusting is acceptable.

5.0 GENERAL TECHNICAL REQUIREMENTS:

Sr. No.	DESCRIPTION	REQUIREMENT
1	Material of earthing coil	GI wire
2	Confirming Standard	IS 280, IS 7887, IS 4826
3	Nominal diameter of Wire	4.00mm with tolerance $\pm 2.5\%$
4	No. of Turns	115 Nos. (Min)
5	External dia of Coil	50mm (Min)
6	Length of Coil	460mm / 450mm (Min)
7	Free Length of G.I wire of earthing coil	2500mm
8	Mass of Zinc Coating	280gm/Sq.mm (Before Coiling) & 266gm/Sq. mm (After Coiling)
9	Total Weight of Coil	1.850 Kgs. (Min)
10	Tolerance in Dimensions & Weight	$\pm 2.5\%$

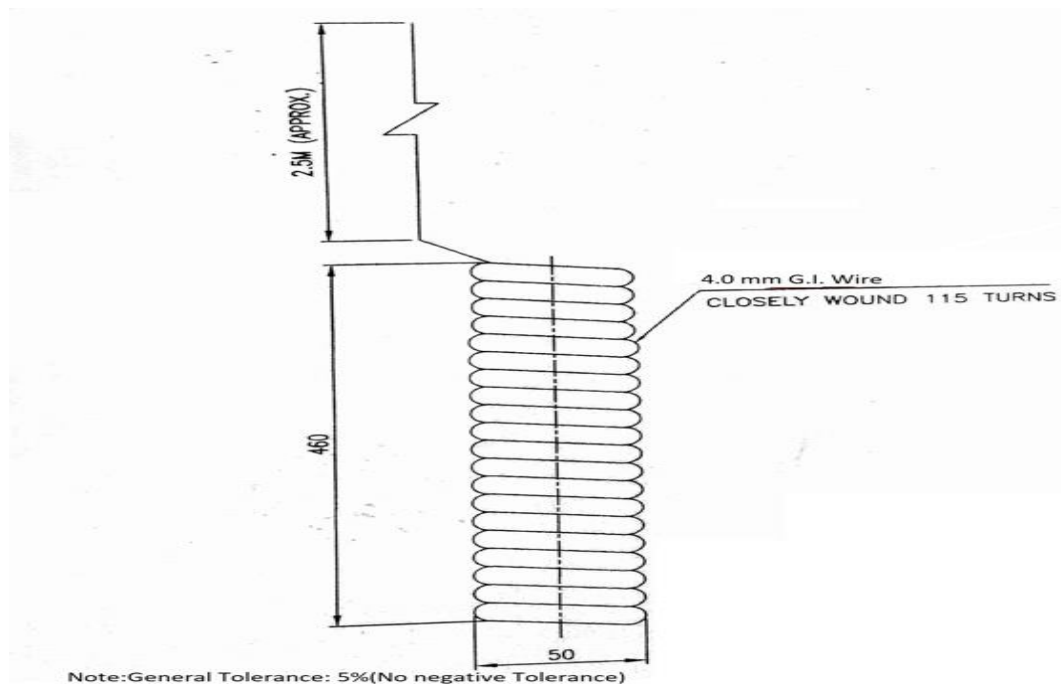

6.0 MARKING:

The unit shall be appropriately marked as "**PROPERTY OF TPCODL/TPNODL/TPWODL/TPSODL**" and with the name of the vendor and year of manufacturing at suitable location.

7.0 TESTS

All routine, acceptance & type tests shall be carried out in accordance with the relevant IS/IEC. All routine/acceptance tests shall be witnessed by the purchaser/his authorized representative. All components shall also be type tested as per the relevant standards.

Tests	IS to be referred
Visual test	As a routine test
Dimensional tests	As per the drawing
Tensile test	IS 280
Wrapping test	IS 280
Hot dip galvanizing	IS 4826
Determination of mass of zinc coating on zinc coated iron and steel	IS 4826

8.0 TYPE TEST CERTIFICATE

The bidder shall furnish the type test certificates of the Specification for GI Coil Earthing for the tests as mentioned above as per the corresponding standards. All the tests shall be conducted at CPRI/ERDA/NABL accredited as per the relevant standards. Type test should have been conducted during the period not exceeding 5 years from the date of opening the bid. In the event of any discrepancy in the test reports i.e. any test report not acceptable or any/all type tests (including additional type tests, if any) not carried out, same shall be carried out without any cost implication to TPCODL/TPNODL/TPWODL/TPSODL.

9.0 PRE DISPATCH INSPECTION

Equipment shall be subjected to inspection by a duly authorized representative of TPCODL/TPNODL/TPWODL/TPSODL. Inspection may be made at any stage of manufacture at the discretion of the purchaser and the equipment, if found unsatisfactory as to workmanship or material, the same is liable to rejection. Bidder shall grant free access to the places of manufacture to TPCODL/TPNODL/TPWODL/TPSODL's representatives at all times when the work is in progress. Inspection by TPCODL/TPNODL/TPWODL/TPSODL or its authorized representatives shall not relieve the bidder of his obligation of furnishing equipment in accordance with the specifications. Material shall be dispatched after specific MDCC (Material Dispatch Clearance Certificate) is issued by TPCODL/TPNODL/TPWODL/TPSODL. Following documents shall be sent along with material.

- a) Test reports
- b) MDCC issued by TPCODL/TPNODL/TPWODL/TPSODL
- c) Invoice in duplicate
- d) Packing list
- e) Drawings & catalogue
- f) Guarantee / Warrantee card
- g) Delivery Challan
- h) Other Documents (as applicable)

10.0 INSPECTION AFTER RECEIPT AT STORES



Document No: ENG-HV-2036

Document Title: Specification GI Coil Earthing

The material received at TPCODL/TPNODL/TPWODL/TPSODL, Berhampur, Odisha store will be inspected for acceptance and shall be liable for rejection, if found different from the reports of the pre-dispatch inspection and one copy of the report shall be sent to Project Engineering department.

11.0 GUARANTEE

Bidder shall stand guarantee towards design, materials, workmanship & quality of process / manufacturing of items under this contract for due and intended performance of the same, as an integrated product delivered under this contract. In the event any defect is found by the Company up to a period of at least 12 months from the date of commissioning or 24 months from the date of last supplies made under the contract whichever is later. In the event any defect is found by the Company up to a period of 12 months from the date of commissioning or 24 months from the date of last supplies made under the contract, whichever is earlier, supplier shall be liable to undertake to replace/rectify such defects at his own costs.

12.0 PACKING

Bidder shall ensure that all the equipment covered under this specification shall be prepared for rail/road transport in a manner so as to protect the equipment from damage in transit.

13.0 TENDER SAMPLE

Not Applicable.

14.0 QUALITY CONTROL

The bidder shall submit with the offer Quality assurance plan indicating the various stages of inspection, the tests and checks which will be carried out on the material of construction, components during manufacture and bought out items and fully assembled component and equipment after finishing. As part of the plan, a schedule for stage and final inspection within the parameters of the delivery schedule shall be furnished. TPCODL/TPNODL/TPWODL/TPSODL's engineer or its nominated representative shall have free access to the manufacturer's/sub-supplier's works to carry out inspections.

15.0 MINIMUM TESTING FACILITIES

Bidder shall have adequate in house testing facilities for carrying out all routine tests & acceptance tests as per relevant International / Indian standards

16.0 MANUFACTURING ACTIVITIES

The successful bidder will have to submit the bar chart for various manufacturing activities clearly elaborating each stage, with quantity. This bar chart should be in line with the Quality assurance plan submitted with the offer. This bar chart will have to be submitted within 15 days from the release of the order.

17.0 SPARES, ACCESSORIES AND TOOLS

NA

18.0 DRAWINGS

Following drawings & documents shall be prepared based on Purchaser's specifications and statutory requirements with complete BOM and shall be submitted with the bid:

- a) Completely filled-in Technical Parameters (refer Cl. 5)
- b) General description of the equipment and all components including brochures
- c) General arrangement drawings
- d) Type Test Certificates.
- e) Experience List
- f) Manufacturing schedule and test schedule after the contract, four (4) copies of the drawings, drawn to scale, describing the equipment in detail shall be forwarded for approval and shall subsequently provide four (4) complete sets of final drawings, one of which shall be auto positive suitable for reproduction, before the dispatch of the equipment. Soft copy (Compact Disk CD) of all the drawing, GTP, test certificates shall be submitted after the final approval of the same to the purchaser.



Document No: ENG-HV-2036

Document Title: Specification GI Coil Earthing

Following Drawings/Documents shall be submitted after the award of the contract:
Drawings/documents to be submitted after the award of the contract:

S.No	Description	For Approval	For Review Information	Final Submission
1	Technical Parameters	√		√
2	General Arrangement drawings	√		√
3	Bill Of Material	√		√
4	Instruction for Use		√	√
5	QA &QC Plan	√	√	√
6	Routine, Acceptance & Type Test Certificates	√	√	√

All the documents & drawings shall be in English language.

19.0 SCHEDULE OF DEVIATIONS

SCHEDULE OF DEVIATIONS

(TO BE ENCLOSED WITH TECHNICAL BID)

All deviations from this specification shall be set out by the Bidders, clause by Clause in this schedule. Unless specifically mentioned in this Schedule, the tender shall be deemed to confirm the purchaser's specifications:

S.No	Clause No.	Details of deviation with justifications

We confirm that there are no deviations apart from those detailed above.

Seal of the Company:

Signature
Designation

STANDARD TECHNICAL SPECIFICATION COVER SHEET

Specification No. : ENG-GEN-4006

Specification Name : GI EARTHING PIPE

Ranjan Kumar Sahoo	SATYA PRASAD NAYAK	SHANTAPRIYA JENA	JYOTIPRAKASH MOHANTY	Shailendra Kumar Jaiswal	SHIRISH SHARAD DIKAY
Prepared by	Reviewed by	Reviewed by	Reviewed by	Approved by	Released by
TPSODL	TPCODL	TPNODL	TPWODL	TPSODL	TPSODL
21-12-2022	21-12-2022	22-12-2022	22-12-2022	22-12-2022	22-12-2022

*Property of TATA POWER ODISHA DISCOMs – Not to be reproduced without permission of TPCODL/ TPNODL/ TPSODL/
TPWODL*

CONTENTS

1. SCOPE
2. APPLICABLE STANDARDS
3. CLIMATIC CONDITIONS OF THE INSTALLATION
4. GENERAL TECHNICAL REQUIREMENTS
5. GENERAL CONSTRUCTIONS
6. MARKING
7. TESTS
8. TYPE TEST CERTIFICATES
9. PRE-DISPATCH INSPECTION
10. INSPECTION AFTER RECEIPT AT STORES
11. GUARANTEE
12. PACKING
13. TENDER SAMPLE
14. QUALITY CONTROL
15. TESTING FACILITIES
16. MANUFACTURING ACTIVITIES
17. SPARES, ACCESSORIES AND TOOLS
18. DRAWINGS AND DOCUMENTS
19. SCHEDULE "A" GUARANTEED TECHNICAL PARTICULARS
20. SCHEDULE "B" DEVIATIONS

1. SCOPE:

The specification covers technical requirements of design, Manufacturing, testing, Inspection, supply and transportation of Heavy type GI Earth Pipe Electrode. Scope also includes transportation & unloading at store / site.

2. APPLICABLE STANDARDS:

The equipment covered by this specification shall unless otherwise stated, be designed, manufactured and tested in accordance with the latest editions of the following Indian, International Standards and shall conform to the regulations of the local authorities:

IS 1239 (Part-1)	Specification of steel tubes, Tubular and other wrought steel fittings
IS 1239 (Part-2)	Specification of steel tubes, Tubular and other steel fittings
IS 10748	Hot- rolled steel strip for Welded Tubes and Pipes
IS: 228	Methods of Chemical analysis for steels
IS: 4759	Specification for Hot Dip Zinc Coating on structural steel and other allied products
IS: 4711	Methods for sampling of steel pipes, tubes, fittings
IS 3043	Code for practice of Earthing

3. CLIMATIC CONDITIONS OF THE INSTALLATION:

1	Maximum ambient temperature	50 deg C
2	Max. Daily average ambient temp	35 deg C
3	Min Ambient Temperature	0 deg C
4	Maximum Humidity	95%
5	Average Annual Rainfall	150cm
6	Average No. of rainy days per annum	120
7	Altitude above MSL not exceeding	1000m
8	Wind Pressure	300 Km/hr
9	Earthquakes of an intensity in horizontal direction	equivalent to seismic acceleration of 0.3g
10	Earthquakes of an intensity in vertical direction	equivalent to seismic acceleration of 0.15g (g being acceleration due to gravity)

TPCODL/TPNODL/TPSODL/TPWODL service area has heavy saline conditions along the coast and High cyclonic Intensity winds with speed upto 300 Kmph. The atmosphere is generally laden with mild acid and dust in suspension during the dry months and is subjected to fog in cold months.

4. GENERAL TECHNICAL REQUIREMENTS:

SL. No	TECHNICAL PARTICULAR	DESIRED VALUE		
1	Diameter of earthing Pipe	40 mm dia	50 mm dia	100 mm dia
2	Standard	IS 1239	IS 1239	IS 1239
3	Material	GI Pipe	GI Pipe	GI Pipe
4	Make	JINDAL /TATA	JINDAL /TATA	JINDAL /TATA
5	Class	Heavy	Heavy	Heavy
6	Outdoor diameter	47.9 mm min. to 48.8 mm max.	59.7 mm min. to 60.8 mm max.	113.1 mm min. to 115 mm max.
7	Wall thickness	4 mm	4.5 mm	5.4 mm
8	% of Elongation	20	20	20
9	Tensile strength	320 N/mm ²	320 N/mm ²	320 N/mm ²
10	Length of pipe earthing	3000 mm	3000 mm	3000 mm
11	Dimensions of holes	12 mm	12 mm	12 mm
12	Tolerance on dimensions/weight	+/-5 %	+/-5 %	+/-5 %
13	Galvanizing shall confirm	IS:4736, IS: 2633, IS: 2629	IS:4736, IS: 2633, IS: 2629	IS:4736, IS:2633, IS: 2629
14	Dimension of clamp	50 x 6 GI flat	50 x 6 GI flat	50 x 6 GI flat
15	Weight of Pipe (As per IS 1239 Part-1(2004))	4.37Kg/Mtr.	6.19Kg/Mtr.	14.5Kg/Mtr.
16	Center of Hole	150mm	150mm	150mm

Note: - For design and other parameter refer to the drawing on page No:-7.

5. GENERAL CONSTRUCTION:

For welded and seamless plain end steel tubes intended for different use in electricity distribution utility shall comply IS 1239 (Part-1). Plain ends of the tubes are cleanly finished by normal deburring process. For tubes with thickness up to 6 mm, the minimum mass of zinc coating in accordance with IS: 6745, shall be 400g/mm². The Zinc coating on the tube shall be uniform and tested in accordance with IS 4736. The welded tubes shall be manufactured from hot rolled steel strip for welded tubes and pipes confirming to IS 10748. Pipe shall be strictly from approved vendors i.e. TATA/JINDAL. The hot dip galvanization shall be done only after the all fabrication and welding done. Zinc

electroplated/painted material will not be accepted. The nut bolt and washers provided shall be as per the relevant IS. Chemical composition for GI earth pipe are in below:

Carbon: 0.20% (max.)

Manganese: 1.30% (max.)

Phosphorus: 0.04% (max.)

Sulphur: 0.04% (max.)

6. MARKING:

The unit shall be appropriately marked as

- a) TPCODL/TPNODL/TPSODL/TPWODL
- b) Manufacture's name or trademark
- c) Year of Manufacturing

7. TESTS:

The bidder shall be required to submit complete set of the following test reports along with the offer:-

7.1 ACCEPTANCE TESTS

- i) Visual Inspection
- ii) Verification of Dimensions
- iii) Tensile Strength
- iv) Bend Test
- v) Hot Dip galvanizing
- vi) Determination of mass of Zinc coating on Zinc coated iron and steel

7.2 ROUTINE TESTS

Same as Acceptance Test

7.3 TYPE TESTS

- i) Visual Inspection
- ii) Verification of Dimensions
- iii) Tensile Strength
- iv) Bend Test
- v) Flattening test (dia.>50mm)
- vi) Hot Dip galvanizing
- vii) Determination of mass of Zinc coating on Zinc coated iron and steel

8. TYPE TEST CERTIFICATES:

The Bidder shall furnish the type test certificates for the tests as mentioned above as per the corresponding standards. All the tests shall be conducted at **CPRI / ERDA / Other Government/NABL Accredited Labs** as per relevant IS. Type tests should have been conducted during the period not exceeding 5 years from the date of opening the bid. In the event of any discrepancy in the test reports, i.e. any test report not acceptable, same shall be carried out without any cost implication to TPCODL/TPNODL/TPSODL/TPWODL.

9. PRE-DISPATCH INSPECTION:

The material shall be subject to inspection by a duly authorized representative of the TPCODL/TPNODL/TPSODL/TPWODL. Inspection may be made at any stage of manufacture at the discretion of the purchaser and the equipment, if found unsatisfactory as to workmanship or material, the same is liable to rejection. Bidder shall grant free access to the places of manufacture to TPCODL/TPNODL/TPSODL/TPWODL 's representatives at all times when the work is in progress. Inspection by the TPCODL/TPNODL/TPSODL/TPWODL or its authorized representatives shall not relieve the bidder of his obligation of furnishing equipment in accordance with the specifications. Material shall be dispatched after specific MDCC (Material Dispatch Clearance Certificate) is issued by TPCODL/TPNODL/TPSODL/TPWODL.

Following documents shall be sent along with material.

- a) Test reports
- b) MDCC issued by TPCODL/TPNODL/TPSODL/TPWODL
- c) TPCODL/TPNODL/TPSODL/TPWODL Invoice in duplicate
- d) Packing list
- e) Drawings & catalogue
- f) Guarantee / Warrantee card
- g) Delivery Challan
- h) Other Documents (as applicable)

10. INSPECTION AFTER RECEIPT AT STORE:

The material received at TPCODL/TPNODL/TPSODL/TPWODL, Odisha store will be inspected for acceptance and shall be liable for rejection, if found different from the reports of the pre-dispatch inspection and one copy of the report shall be sent to Engineering department.

11. GUARANTEE:

Bidder shall stand guarantee towards design, materials, workmanship & quality of process/ manufacturing of items under the contract for due and intended performance of the same, as an integrated product delivered under this contract. In the event any defect is found by the Company up to a period of 18 months from the date of commissioning or 24 months from the date of last supplies made under the contract, whichever is earlier, supplier shall be liable to undertake to replace/rectify such defects at his own costs. within mutually agreed timeframe, and to the entire satisfaction of the Company, failing which the Company will be at liberty to get it replaced/rectified at supplier's risks and costs and recover all such expenses plus the Company's own charges (@ 20% of expenses incurred), from the supplier or from the "Security cum Performance Deposit" as the case may be.

12. PACKING:

Supplier shall ensure that all material covered by this specification shall be prepared for rail/road transport (local equipment) and be packed in such a manner as to protect it from damage in transit. The bidder shall provide instructions regarding handling and storage precautions to be taken at site.

13. TENDER SAMPLE:

Not Applicable

14. QUALITY CONTROL:

The bidder shall submit QAP indicating the various stages of inspection, the tests and checks which will be carried out on the material of construction, components during manufacture and bought out items and fully assembled component and equipment after finishing. As part of the plan, a schedule for stage and final inspection within the parameters of the delivery schedule shall be furnished. The Purchaser's engineer or its nominated representative shall have free access to the manufacturer's/sub-supplier's works to carry out inspections.

15. TESTING FACILITIES:

Supplier/ Manufacturer shall have adequate in house testing facilities for carrying out all routine tests & acceptance tests as per relevant Indian standards.

16. MANUFACTURING FACILITIES:

The successful bidder shall submit the bar chart for various manufacturing activities clearly elaborating each stage, with quantity. This bar chart should be in line with the Quality assurance plan submitted with the offer.

17. SPARES, ACCESSORIES AND TOOLS

Not applicable.

18. DRAWINGS AND DOCUMENTS:

Following drawings and documents shall be submitted in line with the requirement of Tender specifications:

- a) Completely filled in Schedule “A” Guaranteed Technical Particulars & Schedule “B” Deviations
- b) Work Experience details
- c) Type test certificates
- d) Drawing 1 set of Hard Copy & Soft copy PDF File containing complete information about manufacturing

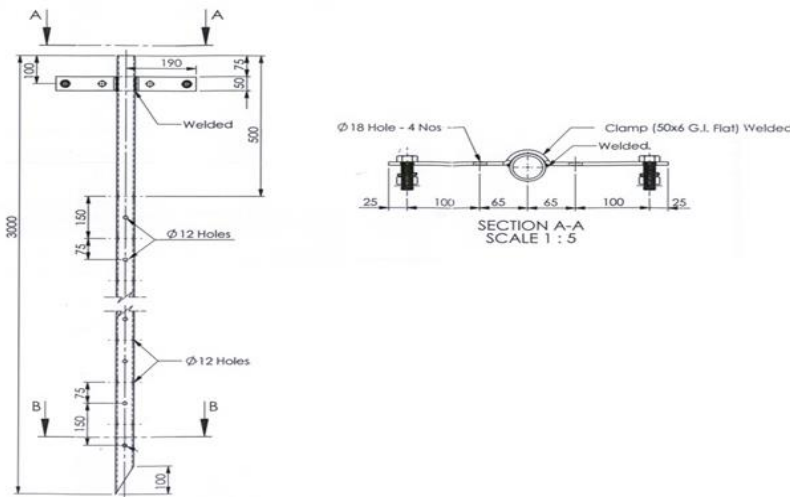

NOTE: - The drawing is for tender purpose only.

19. SCHEDULE- “A” GUARANTEED TECHNICAL PARTICULARS:-

SL. No	TECHNICAL PARTICULAR	TO BE FURNISHED BY THE BIDDER		
1	Diameter of earthing Pipe	40 mm dia	50 mm dia	100 mm dia
2	Standard			
3	Material			
4	Make			
5	Class			
6	Outdoor diameter			
7	Wall thickness			
8	% of Elongation			
9	Tensile strength			
10	Length of pipe earthing			
11	Dimensions of holes			

12	Tolerance on dimensions/weight			
13	Galvanizing shall confirm			
14	Dimension of clamp			

20. SCHEDULE "B" DEVIATIONS:

(TO BE ENCLOSED WITH TECHNICAL BID)

All deviations from this specification shall be set out by the Bidders, clause by Clause in this schedule. Unless specifically mentioned in this Schedule, the tender shall be deemed to confirm the purchaser's specifications:

SL. No	Clause No.	Details of deviation with justifications

We confirm that there are no deviations apart from those detailed above.

Seal of the Company:

Signature

Designation

ANNEXURE-VII

	TP CENTRAL ODISHA DISTRIBUTION LIMITED	
	WORK INSTRUCTION /OPERATING GUIDELINES	
Doc. Title	GENERAL CONDITIONS OF CONTRACT –SUPPLY ORDERS	
Rev. No	0	Page 1 of 43

CONTENTS	
CLAUSE NO.	DESCRIPTION
1.0	ORGANIZATIONAL VALUES
2.0	ETHICS
3.0	CONTRACT PARAMETERS
3.1	Issue/Award of Contract
3.2	Contract Commencement Date
3.3	Contract Completion Date
3.4	Contract Period/ Time
3.5	Contract Execution Completion Date
3.6	Contract Price /Value
3.7	Contract Document
3.8	Contract Language
3.9	Reverse Auction
4.0	SCOPE OF WORK
5.0	PRICES/RATES/TAXES
5.1	Changes in statutory Tax Structure
6.0	TERMS OF PAYMENT
6.1	Quantity Variation
6.2	Full and Final Payment
7.0	MODE OF PAYMENT
8.0	SECURITY CUM PERFORMANCE DEPOSIT
9.0	STATUTORY COMPLIANCE
9.1	Compliance to Various Acts
9.2	SA 8000
9.3	Affirmative Action
10.0	QUALITY
10.1	Knowledge of Requirements
10.2	Material/Equipment/Works Quality
10.3	Adherence to Rules & Regulations
10.4	Specifications and Standards
11.0	INSPECTION/PARTICIPATION
11.1	Right to Carry Out Inspection
11.2	Facilitating Inspection
11.3	Third Party Nomination
11.4	Waiver of Inspections
11.5	Incorrect Inspection Call

CONTENTS	
CLAUSE NO.	DESCRIPTION
12.0	MDCC & DELIVERY OF MATERIALS
12.1	Material Dispatch Clearance Certificate
12.2	Right to Rejection on Receipt
12.3	Consignee
12.4	Submission of Mandatory Documents on Delivery
12.5	Dispatch and Delivery Instructions
13.0	GUARANTEE
13.1	Guarantee of Performance
13.2	Guarantee period
13.3	Failure in Guarantee period (GP)
13.4	Cost of repairs on failure in GP
13.5	Guarantee Period for Goods Outsourced
13.6	Latent Defect
13.7	Support beyond the Guarantee Period
14.0	LIQUIDATED DAMAGES
14.1	LD Waiver Request
15.0	UNLAWFUL ACTIVITIES
16.0	CONFIDENTIALITY
16.1	Documents
16.2	Geographical Data
16.3	Associate's Processes
16.4	Exclusions
16.5	Violation
17.0	INTELLECTUAL PROPERTY RIGHTS
18.0	INDEMNITY
19.0	LIABILITY & LIMITATIONS
19.1	Liability
19.2	Limitation of Liability
20.0	FORCE MAJEURE
21.0	SUSPENSION OF CONTRACT
21.1	Suspension for Convenience
21.2	Suspension for Breach of Contract Conditions
21.3	Compensation in lieu of Suspension
22.0	TERMINATION OF CONTRACT
22.1	Termination for Default/Breach of Contract
22.2	Termination for Convenience of Associate
22.3	Termination for Convenience of TPCODL

Doc. Title	GENERAL CONDITIONS OF CONTRACT FOR SUPPLY ORDERS	
Rev. No	0	Page 3 of 43

CONTENTS	
CLAUSE NO.	DESCRIPTION
23.0	DISPUTE RESOLUTION AND ARBITRATION
23.1	Governing Laws and jurisdiction
24.0	ATTRIBUTES OF GCC
24.1	Cancellation
24.2	Severability
24.3	Order of Priority
25.0	ERRORS AND OMISSIONS
26.0	TRANSFER OF TITLES
27.0	INSURANCE
28.0	SUGGESTIONS & FEEDBACK
29.0	CONTACT POINTS
30.0	LIST OF ANNEXURES

GENERAL CONDITIONS OF CONTRACT

Doc. Title	GENERAL CONDITIONS OF CONTRACT FOR SUPPLY ORDERS	
Rev. No	0	Page 4 of 43

1.0 ORGANIZATIONAL VALUES

The Tata Group has always been a value driven organization. These values continue to direct the Group's growth and businesses. The six core Tata Values underpinning the way we do business are:

Integrity - We must conduct our business fairly, with honesty and transparency. Everything we do must stand the test of public scrutiny.

Understanding - We must be caring, respectful, compassionate and humanitarian towards our colleagues and customers around the world and always work for the benefit of India.

Excellence - We must constantly strive to achieve the highest possible standards in our day to day work and in the quality of goods and services we provide.

Unity - We must work cohesively with our colleagues across the group and with our customers and partners around the world to build strong relationships based on tolerance, understanding and mutual co-operation.

Responsibility - We must continue to be responsible and sensitive to the countries, communities and environments in which we work, always ensuring that what comes from the people goes back to the people many times over.

Agility - We must work in a speedy and responsive manner and be proactive and innovative in our approach.

2.0 ETHICS

In our effort towards Excellence and in Management of Business Ethics at TPCODL, an Ethics Management Team is constituted.

The main objective of the Ethics Management Team is to:

1. Record, address and allay the issues and concerns on ethics raised by different stakeholders like employees, consumers, vendors, Associates etc. by initiating immediate corrective actions.
2. Ensure proper communication of the ethics policies and guidelines through prominent displays at all offices of TPCODL and through printed declarations in all concerned documents where external stakeholders are involved.
3. Ensure proper framework of policies as preventive measures against any ethics violation recorded by them.
4. Prepare and submit MIS of all issues and concerns, corrective and preventive actions on monthly basis to the top management for their information.

All Associates and Stakeholders are requested to register any grievance on ethics violation on our website www.tpccentralodisha.com.

3.0 CONTRACT PARAMETERS

3.1 Issue/Award of Contract

TPCODL awards the contract to the Associate in writing in the form of Purchase Order (PO) or Rate Contract (RC), hereafter referred as Contract, through in any or all of following modes physical handover / post / e-mail / web document / fax with all the attachments/enclosures which shall be part of the contract document.

Doc. Title	GENERAL CONDITIONS OF CONTRACT FOR SUPPLY ORDERS	
Rev. No	0	Page 5 of 43

On receipt of the contract, the associate shall return to TPCODL copy of the contract document duly signed by legally authorized representative of associate, within two days of Effective Date of Contract for contracts having contract execution time less than 30 days and within five days for all other contracts.

3.2 Contract Commencement Date

The date of issue/award of contract shall be the Effective Date of Contract or Contract Commencement date.

3.3 Contract Completion Date

The date of expiry of Guarantee Period shall be deemed as the Contract Completion Date.

3.4 Contract Period/Time

The period from Contract Commencement Date to Contract Completion Date shall be deemed as the Contract Period/Time.

3.5 Contract Execution Completion Date

The stipulated date for completing the supply as per schedule of quantities shall be deemed as the Contract Execution Completion Date.

3.6 Contract Price /Value

The total all inclusive price/value mentioned in the PO/RC is the Contract Price/Value and is based on the quantity, unit rates and prices quoted and awarded and shall be subject to adjustment based on actual quantities supplied and accepted and certified by the authorized representative of the company unless otherwise specified in schedule of quantities or in contract documents.

3.7 Contract Document

The Contract Document shall mean and include but not limited to the following:

- NIT/Tender Enquiry, QR, Instruction to Bidders, Special Condition of Contract (SCC) of tender, GCC, Technical & Commercial Specifications including relevant annexure and attachments).
- Bids & Proposals Received from Associate including relevant annexure/attachments.
- RC/PO with agreed deviations from the tender/bid documents.
- All the Inspection and Test reports, Detailed Engineering Drawings.
- Material Dispatch Clearance Certificate (MDCC).
- Minutes of Meeting (MoM)

3.8 Contract Language

All documents, instructions, catalogues, brochures, pamphlets, design data, norms and calculations, drawings, operation, maintenance and safety manuals, reports, labels, on deliveries and any other data shall be in English Language.

The Contract documents and all correspondence between the TPCODL, Third Parties associated with the contract, and the Associate shall be in English language.

However, all signboards required indicating "Danger" and/or security at site and otherwise statutory required shall be in English, Hindi, and local languages.

Doc. Title	GENERAL CONDITIONS OF CONTRACT FOR SUPPLY ORDERS	
Rev. No	0	Page 6 of 43

3.9 Reverse Auction

TPCODL reserves the right to conduct the reverse auction (instead of public opening of price bids) for the products / services being asked for in the tender. The terms and conditions for such reverse auction events shall be as per the Acceptance Form attached in Annexure F.

4.0 SCOPE OF WORK

All the activities that are to be undertaken by the Associate to realize the contractual deliverables in completeness form Scope of Work. Following clauses list, but not limited to, major requirements of the scope of work.

The associate shall satisfy himself and undertake fully the technical/commercial requirements of items to be supplied as listed in the Schedule of Quantities together with the tests to be performed /test reports to be furnished before dispatch, arrangement of stage and final inspections during manufacturing as per terms and conditions of contract, technical parameters & delivery terms and conditions including transit insurance to be met in order to fully meet TPCODL's requirements.

Completeness: Any supplies and services which might have not been specifically mentioned in the Contract but are necessary for the scope mentioned in Special Terms & Conditions and/or completeness of the works at the highest possible level, including any royalties, license fees & compensation to be paid, whether incurred by the associates or by a third party for the work covered in the scope, regardless of when incurred, shall be supplied/provided by the associate without any extra cost and within the time schedule for efficient, smooth and satisfactory operation and maintenance of the works at the highest possible level under Indian conditions (but according to international standards for facility of this type), unless expressly excluded from the scope of supplies and services in this Contract.

TPCODL have the right, during the performance of the Contract, to change the scope and/or technical character of the Project and/or of the supplies and services stipulated in the Contract by submitting a request in writing to the Associate. The Associate shall, within fifteen days of receipt of such request from the TPCODL, provide Purchaser with a reasonably detailed estimate of the cost of the change outlined in the request.

In the event, TPCODL requests a change, the Contract price and time shall be adjusted upwards or downwards, as the case may be and shall be mutually agreed to. The associate shall not be entitled to any extension of time unless such changes adversely affect the time schedule.

The Associate shall not proceed with the changes as requested till adjustment of contract price and time schedule where so applicable in terms of or otherwise directed by the TPCODL.

5.0 PRICES/RATES/TAXES

Unless specified elsewhere in the contract document, the prices/rates are inclusive of cost of finished product for which MDCC will be issued by TPCODL, packaging and forwarding charges, freight and transit insurance charges covering loading at Associate's works, transportation to TPCODL store/site & unloading & delivery at TPCODL stores/TPCODL site, cost of documentation including all the relevant test certificates and other supportive documents to be furnished.

The Prices/Rates are inclusive of all taxes, levies, cess and duties, particularly Goods and Services Tax as applicable. All government levy / taxes shall be paid only when the invoice is submitted according to the relevant act.

Doc. Title	GENERAL CONDITIONS OF CONTRACT FOR SUPPLY ORDERS	
Rev. No	0	Page 7 of 43

The prices/rates shall remain firm till actual completion of entire supply of goods/material/equipment as per contract is achieved and shall remain valid till the completion of the contract.

The prices shall remain unchanged irrespective of TPCODL making changes in quantum in all or any of the schedules of items of contract.

5.1 Changes in Statutory Tax Structure

If rate of any or all of the statutory taxes and duties applicable to the contract changes, such changes shall be incorporated by default if the changes occur within the contract execution time and shall be applicable if the contract is executed by the Associate within the Contract Execution Time.

For execution of contracts beyond contract execution time, where the delay is not attributable to TPCODL no upward revision in tax /duties shall be considered irrespective of changes in the statutory tax structure either within the contract execution time or beyond. However, in such cases, benefits due to any downward revisions in statutory tax rates shall be passed on to TPCODL.

6.0 TERMS OF PAYMENT

On delivery of the materials in good condition and certification of acceptance by TPCODL official, Associate shall submit the Bills/Invoices in original in the name of "TP Central Odisha Distribution Limited" to invoice desk, complete with all required documents as under:

- Test Reports (4 sets).
- MDCC issued by TPCODL.
- Packing List.
- Drawing and Catalogue.
- Guarantee/Warrantee Card.
- Delivery Challan.
- O&M Manual.
- Copy of Order.
- Minutes of Meeting.

Bills/ invoices shall mention Supplier's GST Number. TPCODL will make 100% payment within 30 days of submission of the Bill/Invoice complete in all respects and along with all the requisite documents mentioned above, subject to condition that Associate has furnished the requisite Security-cum-Performance Guarantee as stipulated in the contract.

6.1 Quantity Variation

Payment will be made on the basis of actual quantity of supplies/actual measurement of works accepted by TPCODL and not on the basis of contract quantity.

6.2 Full and Final Payment

Doc. Title	GENERAL CONDITIONS OF CONTRACT FOR SUPPLY ORDERS	
Rev. No	0	Page 8 of 43

Full & Final Payment in all contracts shall be made subject to the associate submitting "No Demand Certificate" in the format as per Annexure-C.

7.0 MODE OF PAYMENT

Payment shall be made through crossed Cheque or RTGS whichever of the two modes chosen by the Associate, in favour of Associate's Bank Account on TPCODL records, on whose name Contract has been issued. Those Associates opting for the RTGS mode shall submit the details of Bank Account and other details as per annexure G. Further, for any payments made, TPCODL is not responsible for any consequences/disputes Associate have among the owners channel partners, sub-Associates and all such dispute/concerns shall be settled solely by the Associate.

8.0 SECURITY CUM PERFORMANCE DEPOSIT

Associates shall submit within 15 days from the effective date of issue of PO/RC, Security Performance Bank Guarantee (SPBG) in the format as per Annexure B of this document from banks acceptable to TPCODL for:

- (a) 5% of the PO value if purchase order value is more than Rs 5 Crores.
- (b) 10% of the PO value if purchase order value is less than Rs 5 Crores.

This shall remain valid till the end of the Guarantee Period of contract, plus one month.

- (c) 5% of the RC value in case of Rate Contract. This shall remain valid till the Guarantee period plus one month.

- For PO/RC values less than Rs. 5 lacs, Associate may request for deduction of amount equivalent to SPBG value from their first invoice. Such amount shall be withheld by TPCODL while processing the invoice and shall be released after completion of Guarantee Period plus one month.
- For PO/RC values less than Rs. 3 lacs, the clause (8.0) for Security cum Performance Bank Guarantee (SPBG) shall not be applicable.
- In case of RC (Rate Contract) after the expiry of RC validity, Associate shall have to submit SPBG. However, the Associate has the option to re-submit the SPBG as per actual RO (Release Order) value issued against the RC, valid for Guarantee Period plus one month. The Guarantee Period shall be considered as per the last RO issued against the said RC. The original SPBG as submitted against the RC shall be released on submission of the new SPBG to TPCODL. Alternatively, Associate may extend the validity of original SPBG only till the requisite period, i.e. Guarantee Period plus one month.

9.0 STATUTORY COMPLIANCE

9.1 Compliance to Various Acts

Associate should ensure adherence to all applicable laws, rules and regulation applicable under this contract from time to time. In case of violation any risk, costs etc shall be in associates account and keep TDPPL indemnified always till completion of contracts.

Doc. Title	GENERAL CONDITIONS OF CONTRACT FOR SUPPLY ORDERS	
Rev. No	0	Page 9 of 43

9.2 SA 8000

TPCODL expects its Associates to follow guidelines of SA 8000:2014 on the following aspects

1. Child Labour
2. Forced or Compulsory Labour
3. Health & Safety
4. Freedom of Association & Right to Collective Bargaining
5. Discrimination
6. Disciplinary Practices
7. Working Hours
8. Remuneration
9. Management System

9.3 Affirmative Action

TPCODL appreciate and welcome the engagement/employment of persons from SC/ST community or any other deprived section of society by their business associates.

Relaxation in Contract Clauses under Affirmative Action for SC/ ST Business Associates**

TPCODL believes that inclusive growth is the key to sustainable development, and to promote the same Policy on Affirmative Action for Scheduled Caste & Scheduled Tribe Communities has been adopted across the company.

Under the same pre-text, and to promote entrepreneurship among SC/ST community TPCODL has taken initiative by proposing relaxations in contract clauses as per below:

S. No	Initiative	for SC/ ST BA's	Guideline Document
1	Tender Fees	100% waiver for SC/ST community	All Open Tenders
2	Earnest Money Deposit	50 % relaxation of estimated EMD value	All limited and Open Tenders
3	Performance Bank Guarantee	50% relaxation in PBG for order value above 50 lacs else 25% relaxation	All limited and Open tenders
4	Turnover	25% relaxation in company turnover under qualifying requirement criteria	All Open Tenders

**Classification of BAs under SC/ST shall be governed under following guidelines:

- Proprietorship/ Single Ownership Firm: Proprietor of the firm should be from SC/ST community. Governing document shall be duly audited balance Sheet for the last FY bearing the name of proprietor.
- Partnership Firm: Only such firms shall qualify which have SC/ST partners holding equal to or more than 50% of the total ownership pattern of the firm. Governing document shall be Partnership Deed and audited balance sheet/ ITR for last FY.
- Private limited company: Only such firms shall qualify which have SC/ST directors holding equal to or more than 50% of the total ownership pattern of the firm. Governing document shall be Memorandum of Understanding (MoU) and/or Article of Association (AoA).

Doc. Title	GENERAL CONDITIONS OF CONTRACT FOR SUPPLY ORDERS	
Rev. No	0	Page 10 of 43

Governing document shall be Memorandum of Understanding (MoU) and/or Article of Association (AoA).

Note: Certification from SC/ST commission shall be required for deciding upon SC/ST status of a person.

10.0 QUALITY

10.1 Knowledge of Requirements

The Associate shall be deemed to have carefully examined and to have knowledge of the equipment, the general and other conditions, specifications, schedules, drawings, etc. forming part of the Contract and also to have satisfied himself as to the nature and character of the work to be executed and the type of the equipment and duties required including wherever necessary of the site conditions and relevant matters and details. Any information thus procured or otherwise obtained from TPCODL/Consultants shall not in any way relieve the Associate from his responsibility and executing the works in accordance with the terms of contract.

10.2 Material/Equipment/Works Quality

The items / works under the scope of the Associate shall be of the best quality and workmanship according to the latest engineering practice and shall be manufactured from materials of best quality considering strength and durability for their best performance and, in any case, in accordance with the specifications set forth in this Contract. All material shall be new. Substitution of specified material or variation from the process of fabrication/ construction/ manufacture may be permitted but only with the prior written approval of the TPCODL.

10.3 Adherence to Rules & Regulations

The Associate shall procure and/or fabricate/erect all materials and equipment in accordance with all requirements of Central and State enactment, rules and regulations governing such work in India and at site. This shall not be construed as relieving the Associate from complying with any requirement of TPCODL as enumerated in the Contract which may be more rigid than and not contrary to the above mentioned rules, nor providing such construction as may be required by the above mentioned rules and regulations. In case of variance of the Technical Specification from the laws, ordinance, rules and regulations governing the work, the Associate shall immediately notify the same to the TPCODL. It is the sole responsibility of the Associate, however, to determine that such variance exists. Wherever required by rules and regulations, the Associate shall also obtain the statutory authorities' approval for the plant, machinery and equipment to be supplied by the Associate.

10.4 Specifications and Standards

The Associate shall follow all codes and standards referred in the Contract Document. Codes and standards of other may be followed by the Associate with the prior written approval of TPCODL, provided materials, supplies and equipment according to the standard are equal to or better than the corresponding standards specified in the Contract.

Brand names mentioned in the Contract documents are for the purpose of establishing the type and quality of products to be used. The Associate shall not change the brand name and qualities of the bought out items without the prior written approval of the TPCODL. All such products and equipment shall be used or installed in strict accordance with original manufacturer's recommendations, unless otherwise directed by the TPCODL. In any circumstances the codes, specimen and standards prescribed by any government agency should not be violated.

Doc. Title	GENERAL CONDITIONS OF CONTRACT FOR SUPPLY ORDERS	
Rev. No	0	Page 11 of 43

11.0 INSPECTION/PARTICIPATION

11.1 Right to Carry Out Inspection

TPCODL reserves the right to send its representatives for inspection or participation at various stages of contract execution listed below, applicable as per contract construction.

- During basic design and detail engineering of material/ Equipment carried out by Associate /Outsourced Agencies.
- During manufacturing stages of the product at Associate's/Associate's Outsourced Agency's Plant/Facility.
- During Pre-dispatch Inspection and Testing of finished/manufactured product at Associate's/Associate's outsourced Agency's Plant/Facility.
- During Installation & Commissioning Activities/Stages.
- Prior to Clearing of the completed installation for commissioning.
- Any other stage as find appropriate by TPCODL during contract execution time.

All inspections and participations shall be carried out by TPCODL giving written intimation to the Associate or receiving appropriate advance written inspection call from the Associate, unless otherwise specified elsewhere in the contract document.

11.2 Facilitating Inspection

The Associate shall provide all opportunities and information to TPCODL's engineers to get acquainted with the technical know-how and the methods and practices adopted by the Associate in basic and detail engineering. The Associate shall provide documents, drawings, calculations etc. as may be required by TPCODL's Engineers.

The Associate shall provide free of charge office accommodation, office facilities, secretarial services, communication facilities, general and drawing office stationary, etc. as may be reasonably required by the TPCODL's engineers. Similarly, facilities shall also be provided by Associate's outsource agencies/partners/authorized dealers (collectively termed as sub associates) if such basic and detail engineering activities are carried out in the design offices of sub-Associates.

The Associate shall be responsible for the safety of employees of TPCODL/Third Party Agency when they are at the Associate's /Associate's outsource agency's plant or facility for carrying out/witnessing inspection/testing. All statutory safety precautions as applicable shall be followed by the Associate during Inspection Testing. If TPCODL inspectors are not satisfied with the safety arrangements at the plant, TPCODL have the right to call off inspection till such time corrective action is taken by the Associate.

Before raising the call for pre-dispatch final inspection and testing, the Associate shall conduct all the tests—type tests, routine tests etc-as specified in the contract document and submit copies of the test certificates to TPCODL along with the inspection call, for scrutiny of TPCODL.

The Associate and TPCODL shall jointly document all the observations, comments and action points after completion of inspection and it shall be binding on the Associate to provide compliance on all the points requiring compliance and furnish the compliance report to the designated authority of TPCODL for receiving clearance for dispatch of materials

Doc. Title	GENERAL CONDITIONS OF CONTRACT FOR SUPPLY ORDERS	
Rev. No	0	Page 12 of 43

11.3 Third Party Nomination

TPCODL also may nominate a third party for the purpose of carrying out the inspection and such an agency shall be entitled to all the rights and privileges of TPCODL as far as conducting the inspection.

11.4 Waiver of Inspections

TPCODL on its own discretion shall chose to waive off any inspection and ask the Associate to submit all the test reports as applicable as per contract specifications, related to inspection and testing of the goods ordered for scrutiny and clearance for dispatch.

11.5 Incorrect Inspection Call

In case it is observed that the material offered for inspection is not ready at the time of TPCODL inspection visit rendering it as futile, all costs towards such inspection shall be recovered from the BA. Taxes as applicable on such recoveries shall be borne by the BA.

12.0 MDCC & DELIVERY OF MATERIALS

12.1 Material Dispatch Clearance Certificate

Associate shall deliver material/goods/equipment against Supply Contracts or Supply Part of Composite/Service Contracts only after receiving Material Dispatch Clearance Certificate (hereafter termed as MDCC) issued by designated authority of TPCODL. Material delivered at TPCODL stores or at project site without a valid MDCC issued by the designated official of TPCODL shall be rejected. MDCC shall be issued to associate furnishing compliance report on the action points documented during pre-dispatch inspection and testing at Associate's/ Sub Associate's plant/ facility. In case Pre-dispatch inspection is waived at the discretion of TPCODL, then, MDCC shall be issued on receiving all the test reports-routine& type-from the Associate and finding them in order.

The associate shall include and provide for securely protecting and packing the materials so as to avoid loss or damage during handling and transport by air, sea, rail and road or any other means.

All such packing shall allow to the extent possible for easy removal and checking at Site. The associate shall take special precautions to prevent rusting of steel and iron parts during transit by sea. Gas seals or other materials shall be utilized by the associate for protection against moisture during transit of all Plant and Equipment.

Each Equipment or parts of Equipment shall be tagged with reference to the assembly drawings and corresponding part numbers. Each bale or package shall contain a packing note quoting specifically the name of the associate, item description, quantity, item / package identification.

All packing cases, containers, packing and other similar materials shall be new and supplied free by the associate and it shall not be required to be returned to the associate.

Notwithstanding anything stated in this clause, the associate shall be entirely responsible for loss, damage or depreciation or deterioration to the materials and supplies due to faulty and/or insecure packing or otherwise during transportation to the Site until otherwise provided herein.

In case of the consignments dispatched by road, the associate shall ensure that it or its subcontractors:

- i) Identify and obtain the correct type of trucks/trailers, keeping in view the nature of consignments to be dispatched.

ii) Take such actions as may be necessary to avoid all possible chances of damages during transit and to ensure that all packages are firmly secured.

Timelines for inspection and MDCC is as below:

S. No.	Inspection	MDCC issuance time including Inspection time (max.)
1	Outside Bhubaneswar	12 days
2	Within Bhubaneswar	5 days
3	Waiver*	3 working days

* Associate is expected to raise the inspection call assuming that Inspection shall be carried out by TPCODL. The decision for waiver of inspection shall be on sole discretion of TPCODL.

12.2 Right to Rejection on Receipt

Goods/Material/Equipment delivered in condition physically damaged & incomplete as a product ordered, or not packed and transported as per the terms and conditions of the contract is liable to be rejected. Such item shall be lifted back by Associates within 15 days from receipt of rejection note from TPCODL and have to supply back the material within next 30 days or within the timeframe mutually decided by Associate and TPCODL.

If delivery of the material is beyond the agreed time, Liquidated damage clause, mentioned in this GCC separately shall be applicable; but the period for levy of LD shall be considered as per the original delivery schedule and not from the agreed timelines for material rectification.

12.3 Consignee

Unless otherwise specified in the Contract Document, Materials/Goods/Equipment shall be consigned to "Stores-In-Charge", TPCODL, Bhubaneswar.

12.4 Submission of mandatory documents on Delivery

Following documents shall be mandatorily submitted by BA along with supply of material to TPCODL stores/site:

S. No.	Documents	Requisite
1	Invoice copy in original	With all consignments
2	LR copy	Wherever required
3	Packing list	With all consignments
4	MDCC	With all consignments
5	Purchase order / Release order	Signed copy
6	Test certificates	With all consignments
7	Inspection/JVR report	In case pre-dispatch inspection is conducted
8	Device data in CD as per template for metering items	Wherever applicable

12.5 Dispatch and Delivery Instructions

S. No.	Instructions
1	Purchase order/ Release order no. shall be mentioned on invoice and on material

Doc. Title	GENERAL CONDITIONS OF CONTRACT FOR SUPPLY ORDERS	
Rev. No	0	Page 14 of 43

2	TPCODL material code and material description shall be mentioned in invoice and on material.
3	“Property of TPCODL” shall be embossed on material.
4	The material shall be properly sealed and packed in standard packing as per purchase order terms & conditions.
5	The weight and quantity of material shall be mentioned wherever applicable
6	The material supplied shall be co-related with the packing list.
7	The name plate detail on equipment shall include Material code, Material description, specification detail of material [as applicable], Serial No. Year of manufacturing, PO/RO no. and date, “PROPERTY OF TPCODL, Bhubaneswar”, Guarantee period and Associate’s name.
8	In case of manual unloading, supplier / transporter shall deploy sufficient Labour for unloading the material at TPCODL central store. For heavy item(s), crane will be provided by TPCODL [unloading cost will be recovered from the associate].
9	The driver should have valid License and one helper in truck. All the documents of truck like registration papers, PUC etc. should be available in Truck.
10	BA representative should accompany the material and get it unloaded / stacked in his presence wherever possible.

13.0 GUARANTEE

13.1 Guarantee of Performance

Associates shall stand guarantee that the equipment and material supplied under the contract is free from design, manufacturing, material, construction, erection & installation and workmanship & quality defects and is capable of its due, rated and intended quality performance, as an integrated product delivered under the contract, for a specific period termed as Guarantee Period(as elaborated elsewhere in this clause). The Associate should also guarantee that the equipment/material is new and unused except for the usage required for the tests and checks required as part of quality assurance.

13.2 Guarantee Period

The Guarantee Period will be equipment/service/work specific and shall be as specified in the Standard Specifications of TPCODL for the equipment/material/service/work and where standard specifications are not part of contract documents or guarantee period is not specified in the standard specifications,, the guarantee period shall be as per the Special Terms and Conditions of the Contract. In case of no mention of the guarantee period in standard specifications or SCC Guarantee Period will be 12 Months from the Date of Commissioning or 24 months from the date of delivery of final lot of supplies made, whichever is earlier.

13.3 Failure in Guarantee Period (GP)

If the equipment and material supplied under the contract fails to perform its due, rated & intended quality performance, during the Guarantee period, the associate is liable to undertake repair/rectify/replace the equipment and material supplied within time frame specified in the SCC or elsewhere in the contract documents at associate’s cost to make the equipment and material supplied/service or work rendered under the contract of performing its due, rated and intended quality performance. If Associate fails to repair/rectify/replace the equipment or material supplied rendered under the contract, failed in Guarantee Period, TPCODL will be at liberty to get the same done at Associate’s risks and costs and recover all such expenses plus the TPCODL’s own

Doc. Title	GENERAL CONDITIONS OF CONTRACT FOR SUPPLY ORDERS	
Rev. No	0	Page 15 of 43

charges (@ 20% of expenses incurred), from the Associate or from the "Security cum Performance Deposit" as the case may be.

If during the Warranty/ Guarantee period some parts of the supplies are replaced owing to the defects/ damages under the Warranty, the Warranty period for such replaced parts shall be until the expiry of twelve months from the date of such replacement or renewal or until the end of original Guarantee period, whichever is later.

Any repairs during the Guarantee Period shall be carried out by the Associate within 30 days of reporting the issue to Associate by TPCODL. However, if replacement of the Equipment is required, Associate shall notify the same to TPCODL within 7 days of reporting the issue by TPCODL. Thereafter, the total time for supply of new equipment/ material shall be equal to the original delivery period of that equipment/ material as specified in the Contract. In case the Associate is not able to rectify/ replace the faulty equipment/ material within the stipulated timelines as mentioned above, penalty shall be levied as per the Liquidated Damages clause mentioned in this document. The penalty amount shall be recovered from the payment due to the vendor or by encashment of the SPBG as the case may be.

13.4 Cost of repairs on failure in GP

The cost of repairs/rectification/replacement, required transportation, site inspection /mobilization/dismantling and re-installation costs as applicable, to be borne by Associate. The Associate has to ensure that the interruption in the usage of intended purpose of the equipment is minimized to the maximum extent In lieu of the time taken for repairs/rectification/replacement.

13.5 Guarantee period for Goods Outsourced

If the Associate outsources partly equipment/materials/services from third party as mutually agreed upon at the pre award stage of contract, TPCODL shall have the benefit of any additional guarantee period if provided by the third party for the part supplied/executed by them.

13.6 Latent Defect

Hidden defects in manufacturing or design of the product supplied and which could not be identified by the tests conducted but later manifested during operation of the equipment are termed as latent defects. Associates shall further be responsible for 'free replacement' for another period of THREE years from the end of the guarantee period for any 'Latent Defects' if noticed and reported by the Company.

13.7 Support beyond the Guarantee Period

The Associate shall ensure availability of spares and necessary support for a period of atleast 10 years post completion of guarantee period of equipment supplied against the contract.

14.0 LIQUIDATED DAMAGES

- a) For supplies which are of standalone use, multiple in quantities and having a single final delivery schedule, Liquidated damages shall be levied without prejudice to any of the other contractual rights of TPCODL, as described below:

For delay of each week and part thereof from the delivery schedule specified in the contract, 1% of contract value corresponding to undelivered quantity, provided full quantity is supplied within 130% of the original contract time. If full contractual quantity is not delivered within 130% of contract time for delivery, TPCODL has the right to levy LD on the entire contract value, subject to a maximum of 10% of the total contract value.

Doc. Title	GENERAL CONDITIONS OF CONTRACT FOR SUPPLY ORDERS	
Rev. No	0	Page 16 of 43

- b) For Supplies having phased delivery schedule as per contract terms, standalone use and multiple in quantities, Liquidated damages shall be levied without prejudice to any of the other contractual rights of TPCODL, as described below:

For the purpose of calculating and applying LD, each delivery lot shall be considered separately. For delay of each week and part thereof, from the delivery schedule specified for the lot, 1% of the contract value corresponding to the undelivered quantity of the lot subject to a maximum of 10% of the total contract value of the subject lot. However, if full contractual quantity is not delivered within 130% of contract time for delivery, TPCODL has the right to levy LD on the entire contract value, subject to a maximum of 10% of the total contract value. Deduction of LD shall be on landed cost i.e contract value inclusive of taxes and in pursuant statutory compliance GST would be applicable at the stipulated rate and the same shall be borne by Business Associate. In case of LD deduction, a GST invoice shall be issued by TPCODL as a proof of deduction/recovery.

14.1 LD Waiver Request

Any request of LD waiver shall be submitted within thirty (30) days of deducting LD. Request submitted beyond the timeline shall not be entertained.

15.0 UNLAWFUL ACTIVITIES

The Associate shall have to ensure that none of its employees are engaged in any unlawful activities (whether covered under the scope of the present GCC or not) subversive of the TPCODL's interest failing which appropriate action (legal or otherwise) may be taken against the Associate by the TPCODL, in accordance with the terms of the present GCC.

16.0 CONFIDENTIALITY

Associate and its employees or representatives thereof shall strictly maintain the confidentiality of various information they come across while executing the contract as detailed below.

16.1 Documents

All maps, plans, drawings, specifications, schemes and other documents or information related to the Contract/Project and the subject matter contained therein and all other information given to the Associate by the TPCODL in connection with the performance of the contract shall be held confidential by the Associate and shall remain the property of the TPCODL and shall not be used or disclosed to third parties by the Associate for any purpose other than for which they have been supplied or prepared. The Associate may disclose to third parties, upon execution of confidentiality agreements, such part of the drawings, specifications or information if such disclosure is necessary for the performance of the Work provided such third parties agree in writing to keep such information confidential to the same extent and degree as provided herein, for the benefit of the TPCODL.

16.2 Geographical Data

Maps, layouts and photographs of the unit/plant including its surrounding regions showing vital installation for national security of country or those of TPCODL shall not be published or disclosed to the third parties or taken out of the country without prior written approval of the TPCODL and upon execution of confidentiality agreements satisfactory to the TPCODL with such third parties prior to disclosure.

Doc. Title	GENERAL CONDITIONS OF CONTRACT FOR SUPPLY ORDERS	
Rev. No	0	Page 17 of 43

16.3 Associate's Processes

Title to secret processes if any developed by the Associate on an exclusive basis and employed in the design of the equipment shall remain with the Associate. TPCODL shall hold in confidence such processes and shall not disclose such processes to the third parties without prior approval of the Associate and execution by such third parties of secrecy agreements satisfactory to the Associate prior to disclosure. Upon completion of contract, such processes shall become the property of the TPCODL. Title to technical specifications, drawings, flow sheets, norms, calculations, diagrams, interpretations of test results, schematics, layouts and such other information, which the Associate has supplied to the TPCODL under the Contract shall be passed on to the TPCODL. The TPCODL shall have the right to use these for construction, erection, start-up, Trial Run, operation, maintenance, modifications and/or expansion of the works including for the manufacture of spare parts.

16.4 Exclusions

The provision of Clauses 16.1 to 16.3 shall not apply to information:

- Which at the time of disclosure are in the public domain which later on become part of public domain through no fault of the party concerned, or
- Which were in the possession of the party concerned prior to disclosure to him by the other party, or
- Which were received by the party concerned after the time of disclosure without restriction on disclosure or use, from a third party who did not acquire such information directly or indirectly from the other party or has no obligation of confidentiality for such information.

16.5 Violation

In case of violation of this clause, the Associate is liable to pay compensation and damages as may be determined by the competent authority of TPCODL.

17.0 INTELLECTUAL PROPERTY RIGHTS

If, in the course of performance of its functions and duties as envisaged by the scope of the present GCC, the Associate acquires or develops, any unique knowledge or information which would be covered, or, is likely to be covered within the definition of a trademark, copyright, patent, business secret, geographical indication or any other form of intellectual property right, it shall be obliged, under the terms of this present GCC, to share such knowledge or information with the TPCODL. All rights, with respect to, or arising from such intellectual property, as afore mentioned, shall solely vest in TPCODL.

Moreover, the Associate undertakes not to breach any intellectual property right vesting in a third party/parties, whether by breach of statutory provision, passing off, or otherwise. In the event of any such breach, the Associate shall be wholly liable to compensate, indemnify or make good any loss suffered by such third party/parties, or any compensation/damages arising from any legal proceeding/s, or otherwise. No liability of TPCODL shall arise in this respect, and any costs, damages, expenses, compensation payable by TPCODL in this regard to a third party/parties, arising from a legal proceeding/s or otherwise, shall be recoverable from the Associate.

18.0 INDEMNITY

The Associate shall at all times indemnify, keep indemnified and hold harmless the TPCODL and its officers, directors, employees, affiliates, agents, successors and assigns against all actions, claims, demands, costs, charges and expenses arising from or incurred by reason of any

Doc. Title	GENERAL CONDITIONS OF CONTRACT FOR SUPPLY ORDERS	
Rev. No	0	Page 18 of 43

infringement of patent, trade mark, registered design, copy rights and/or industrial property rights by manufacture, sale or use of the equipment supplied by the Associate whether or not the TPCODL is held liable for by any court judgement. In this connection, the TPCODL shall pass on all claims made against him to the Associate for settlement.

The Associate assumes responsibility for and shall indemnify and save harmless the TPCODL from all liability, claims, costs, expenses, taxes and assessments including penalties, punitive damages, attorney's fees and court costs which are or may be required to be paid by the TPCODL and its officers, directors, employees, affiliates, agents, successors and assigns arising from any breach of the Associate's obligations under the Contract or for which the Associate has assumed responsibilities under the Contract including those imposed under any local or national law or laws, or in respect to all salaries, wages or other compensation for all persons employed by the Associate or his Sub-Associates or suppliers in connection with the performance of any work covered by the Contract. The Associate shall execute, deliver and shall cause his Sub-Associate and suppliers to execute and deliver, such other further instruments and to comply with all the requirements of such laws and regulation as may be necessary there under to conform and effectuate the Contract and to protect the TPCODL.

The TPCODL shall not be held responsible for any accident or damages incurred or claims arising, due to the Associate's error there from prior to completion of work. The Associate shall be liable for such accidents and after completion of work for such accidents as the case may be due to negligence on his part to carry out Work in accordance with Indian laws and regulations and the specifications set forth herein.

19.0 LIABILITY & LIMITATIONS

19.1 Liability

Except for any specific liability which may be identified in the Contract and which may be payable hereunder, Associate shall not be liable for any special, incidental, indirect, or consequential Damages or any loss of business Contracts, revenues or other financial loss (or equivalents thereof no matter how claimed, computed or characterized) arising out of or in connection with the Performance of the Work or supply of Goods ***unless caused by Associate's negligence, willful misconduct or breach of contract.***

If the Associate is a joint venture or consortium, all concerned parties shall be jointly and severally bound to the TPCODL for the fulfillment of the provisions of the Contract. The consortium or the joint venture shall designate one party as their leader, who will be the coordinator between the parties and TPCODL. The constituents & leader of the consortium or joint venture shall not be changed without the prior consent of TPCODL.

TPCODL shall have no liability or any special, incidental, indirect or consequential Damages for any loss of Business Contracts, revenues or other financial loss arising out of this Contract.

19.2 Limitation of Liability

The total liability of Associate against any contract shall be limited to the Total All Inclusive Contract Value.

20.0 FORCE MAJEURE

Force Majeure applies if the performance by either Party ("the Affected Party") of its obligations under Contract is materially and adversely affected.

"Force Majeure" shall mean any event or circumstance or combination of events or circumstances referred below and their consequences that wholly or partly prevents or unavoidably delays any

Doc. Title	GENERAL CONDITIONS OF CONTRACT FOR SUPPLY ORDERS	
Rev. No	0	Page 19 of 43

Party in the performance of its obligations under this Agreement, but only and to the extent that such events and circumstances are not within the reasonable control, directly or indirectly, of the Affected Party and could not have been avoided even if the Affected Party had taken reasonable care:

- Act of war (whether declared or undeclared), invasion, armed conflict or act of foreign enemy, embargo, blockade, revolution, riot, bombs, religious strife or civil commotion, etc. ▪ Politically motivated sabotage, or terrorism, etc.
- Action or Act of Government or Governmental agency for which remedy is beyond the control of the affected parties. ▪ Any act of God.

Note: Causes like power breakdown/ shortages/fire/strikes, accidents etc do not fall under Force Majeure.

Time being the essence of the Contract, if either party is prevented from the performance of its obligations in whole or in part due to an event of Force Majeure, then provided Notice of happening of any event by the Affected Party is given to the other party within seven (7) days from the date of occurrence of such event, which DIRECTLY has impact on works and submitted details and quantum of resulting effect, but at the same time had made all possible efforts to mitigate and overcome effects thereof, the Affected Party's performance under this Contract shall be suspended until such event ceases and the Scheduled Completion shall be delayed accordingly.

If Force Majeure event(s) continue for a period of more than three months, the parties shall hold consultation to discuss the further course of action.

Neither party shall be considered to be in default or in breach of its obligation under the Contract to the extent that performance of such obligation by either party is prevented by any circumstances of Force Majeure which arise after effective date of Contract.

Neither party can claim any compensation from the other party on account of Force Majeure.

21.0 SUSPENSION OF CONTRACT

21.1 Suspension for Convenience

TPCODL may, at any time and at its sole option, suspend execution of all or any portions of the schedule of items of contract to be supplied/work to be executed by Associate under the contract by providing to the Associate at least two business days written notice for contracts having contract completion period less than sixty days and at least seven business days' notice for all other contracts.

Upon receipt of any such notice, the Associate shall respond as follows as applicable as per contract construction.

- Immediately discontinue further supply of material/goods specified in the suspension notice for supply contracts
- Immediately discontinue further service/work and supply of materials of those services/materials/work specified in the suspension notice for service /composite contract
- Promptly make every reasonable effort to obtain suspension, upon terms satisfactory to TPCODL, of all orders, outsourcing arrangements, and rental Contracts to the extent that they relate to performance of the portion of Work suspended by the notice.

Doc. Title	GENERAL CONDITIONS OF CONTRACT FOR SUPPLY ORDERS	
Rev. No	0	Page 20 of 43

- Protect and maintain the portion of the service/Work already completed, including the portion of the Work suspended hereunder, unless otherwise specifically stated in the notice.
- Continue delivering/carrying out the supply/service/work items as per contract conditions, which do not fall under purview of the suspension notice.

On receipt of resumption notice from TPCODL, the Associate shall resume execution of contract as specified in the resumption notice, within the time frame specified in the resumption notice.

21.2 Suspension for Breach of Contract conditions.

TPCODL shall suspend execution of whole/or part thereof the contract till such time Associate complies with the conditions stipulated under section clause 22.1 for breach/default of contract conditions.

21.3 Compensation in lieu of Suspension

If the suspension of the contract in whole or in part is for convenience of TPCODL and not due to any breach of contract conditions by the associate, TPCODL at its discretion shall consider compensating all reasonable additional costs incurred by Associate in lieu of suspension of whole or part of contract, on representation of the Associate providing justified estimates of such additional costs and such estimates are found acceptable and approved by competent authority of TPCODL.

If the suspension of contract in whole or part thereof is due to breach of contract conditions (refer clause 22.1) by the Associate, Associate shall not be entitled for any compensation for any cost incurred in lieu of suspension of whole or part of contract and also shall be liable for compensating all the losses arising to TPCODL in lieu of suspension of contract. Resumption notice shall be subject to the Associate taking corrective action for the breach of contract conditions within the time frame and as per the terms specified in the suspension notice.

22 TERMINATION OF CONTRACT

22.1 Termination for Default/Breach of Contract

The contract / PO /RC shall be subject to termination by TPCODL in case of breach of the contract by the Associate which shall include but not be limited to the following:

- a. Withdrawal or intimation by the Associate of its intent to withdraw or surrender the execution / completion of the contracted work /PO or failure in ensuring adherence to any delivery schedules, in deviation of the contract/PO.
- b. Refusal or neglect on the part of the Associate to supply material/equipment of quantity or quality as specified by TPCODL and within the timeframe as specified in the contract document or refusal or neglect to execute the services/work in terms of the agreed standards of quantity or quality and/or within the timeframe specified in the contract/PO.
- c. Failure in any respect to perform any portion of the Work contracted with promptness, diligence, or in accordance with the terms of the contract.
- d. Failure to furnish guarantees as specified and /or failure to comply with the terms thereof.
- e. Failure to furnish such relevant documents or information within the time specified which may be necessary for due execution / completion of the works and documentation.

Doc. Title	GENERAL CONDITIONS OF CONTRACT FOR SUPPLY ORDERS	
Rev. No	0	Page 21 of 43

- f. Liquidation, bankruptcy either voluntary or involuntary OR entering into any composition or compromise with its creditors, or Insolvency.
- g. In case any reasonable information has been received by TPCODL that Associate has adopted/ or attempted to adopt any unethical conduct, action in award of the contract /PO or at any time thereafter.
- h. Failure to comply with applicable statutory provisions as contained in the contract or failure to comply with the applicable laws.
- i. Failure to comply with safety regulations/clauses stipulated in the contract or as may be generally instructed by TPCODL.

If the default or breach as specified under clause 22 (except sub clause g thereof) be committed by the associate for the first time, TPCODL shall issue, along the with notice of default or breach, a warning notice instructing the associate to take remedial/corrective action within the time frame stipulated in the warning notice and not to repeat the same in future. The timeframe for corrective action by the associate shall be specific to the nature of breach of contract and the same shall not be objected to by the Associate. If the Associate fails to comply with the instructions in the warning notice or in taking corrective action to the satisfaction of TPCODL then TPCODL may terminate the entire or part of contract at its discretion by issuing termination notice without incurring any liability on this ground.

In case the contract is terminated for any breach of the nature specified in clause 22 g stated above, TPCODL shall have the right to terminate all the contracts TPCODL is having with the Associate by issuing termination notice which shall be without prejudice to the other rights of TPCODL available to it under law.

Without prejudice to its right to terminate for breach of contract, TPCODL may, without assigning any reason, terminate the Contract in whole or in part at any time at its discretion while the contract is in force by serving a written notice of two weeks to the Associate.

In the event of TPCODL having proceeded with termination of the contract the associate shall comply and proceed further in the following manner:

- a) Associate shall discontinue the supply, on the expiry of the said period of two weeks.
- b) Associate shall ensure that no further steps are being taken towards discharge of the obligations, terms and conditions as contained in the contract/PO. This shall include initiation of actions not limited to discontinuation of other allied and associated arrangements which the associate might have entered into with third parties for due discharge of its obligations under the contract with TPCODL.
- c) The Associate shall perform thereafter such tasks as may be necessary to preserve and protect the terminated portion of the material/service/work in progress and the materials and equipment at TPCODL sites or in transit thereto. However the associate shall continue to fulfill its contractual obligations with regard to the part of contract not terminated.
- d) It shall be open for TPCODL to conduct a joint assessment with the associate of the material, supplies, equipment ,works or in general as to the subject matter of the contract in regard to which the associate claims having completed its obligations before or during such termination.

Doc. Title	GENERAL CONDITIONS OF CONTRACT FOR SUPPLY ORDERS	
Rev. No	0	Page 22 of 43

- e) It shall be open to TPCODL to seek invocation of the performance bank guarantee or any other guarantee or other security deposit by whatever name called submitted by the associate, which shall not be objected to or protested against by the associate.

In case of termination of the contract the parties agree to be governed inter alia by the following:

- a) In case TPCODL exercises its right of termination as stated above the associate shall not dispute or object to the same.
- b) The Associate shall be entitled to receive and claim only such payments OR sums of money from TPCODL as may be found payable to it in regard to works executed by it under the terms of the contract and no other claim of any nature whatsoever shall be made by the Associate.
- c) All such provisions which the parties have agreed to survive and prevail even after termination of the contract shall remain effective despite the termination.

In the event of such termination, TPCODL may finish the Work by whatever method it may deem expedient, including the hiring of services and /or purchase of material equipment from such third parties as TPCODL may deem fit or may itself provide any labor or materials and perform any part of the Work. The associate undertakes to bear the incremental costs if any paid by TPCODL in such a case attributable to failure on the part of the associate. The Associate in such a case shall not be entitled to receive any further payments and any sums found payable to it may be adjusted by TPCODL against the amount recoverable from him on this ground. The same shall be without prejudice to other rights available to TPCODL under law against the associate. Upon the termination of any of the contract due to occurrence of any circumstances provided in clauses stated above and constituting repeated breach or misconduct, TPCODL shall be entitled to bar the associates its agents, affiliates from undertaking any negotiation / tendering, bidding, participation activities concerning TPCODL for a period of two years from date of such termination. The same shall be without prejudice to other rights available to TPCODL.

22.2 Termination for Convenience of Associate

Associate at its convenience may request for termination of contract, clearly assigning the reason for such request. TPCODL has full right to accept, reject or partially accept such request. However, associate shall continue its supply as per contract till final approval is given to associates for such termination.

22.3 Termination for Convenience of TPCODL

TPCODL at its sole discretion may terminate the contract by giving 30 days prior notice in writing or through email to the Associate. TPCODL shall pay the Associate for all the supplies/ services rendered till the actual date of contract termination against submission of invoice by the Associate to that effect.

23.0 DISPUTE RESOLUTION & ARBITRATION

In case of any dispute or difference the parties shall endeavour to resolve the same through conciliatory and amicable measures within 15 Days failing which the matter may be referred by either party for resolution by the sole arbitrator to be appointed mutually by both the parties. The arbitral proceedings shall be conducted in accordance with Arbitration and Conciliation Act 1996 and the place of arbitration shall be Bhubaneswar. The language to be used at proceedings shall be English and the award of the arbitrator shall be final and binding on the parties. The parties shall bear their respective costs of arbitration. The associate shall continue to discharge its obligations towards due performance of the works as per the terms of the contract during the

Doc. Title	GENERAL CONDITIONS OF CONTRACT FOR SUPPLY ORDERS	
Rev. No	0	Page 23 of 43

arbitration proceedings unless otherwise directed in writing by TPCODL or suspended by the arbitrator. Further, TPCODL shall continue making such payments as may be found due and payable to the associate for such works.

23.1 Governing Laws and Jurisdiction

The parties shall be subject to the jurisdiction of the courts of law in Bhubaneswar and any matter arising here from shall be subject to applicable law in force in India.

24.0 ATTRIBUTES OF GCC

24.1 Cancellation

The Company reserves the right to cancel, add, delete at its sole discretion, all or any terms of this GCC or any contract, order or terms agreed between the parties in pursuance without assigning any reasons and without any compensation to the Associates.

24.2 Severability

If any portion of this GCC is held to be void, invalid, or otherwise unenforceable, in whole or part, the remaining portions of this GCC shall remain in effect.

24.3 Order of Priority

In case of any discrepancies between the stipulations in General Conditions of the Contract (GCC) and Special Conditions of Contract (SCC), the GCC shall stand superseded by the SCC to the extent stipulated hereinabove while balance portion of respective clauses of GCC shall continue to be applicable.

25.0 ERRORS AND OMISSIONS

The Associate shall be responsible for all discrepancies, errors and omissions in the drawings, documents or other information submitted by him, irrespective of whether these have been approved, reviewed or otherwise accepted by the TPCODL or not. However any error in design/drawing arising out of any incorrect data/written information from TPCODL will not be considered as error and omissions on part of the Associate.

26.0 TRANSFER OF TITLES

The title of ownership and property to all equipment, materials, drawings & documents shall pass to the TPCODL on acceptance of material by store/site after Inspection.

However, such passing of title of ownership and property to the TPCODL shall not in any way absolve, dilute or diminish the responsibility and obligations of the Associate under this Contract including loss or damages and all risks, which shall vest with the Associate.

27.0 INSURANCE

The Contractor shall take out the Insurance Policies which shall cover all risks including the following, as applicable:-

- a) The value of the policy shall cover the total value of all the items till they are handed over to TPCODL.
- b) TPCODL shall be the principal holder of the policy. The Associate shall be the loss payee under the policy. Associate / Sub-contractor of the Associate shall not be holders or beneficiaries in the policy nor shall they be named in the policy. TPCODL reserves the exclusive right to assign the policy.

Doc. Title	GENERAL CONDITIONS OF CONTRACT FOR SUPPLY ORDERS	
Rev. No	0	Page 24 of 43

- c) While the payment of premium may be phased in agreement with the insurance company, at no time shall goods and services required to be provided by the associate shall remain uninsured in accordance with (a) above.
- d) A copy of the Insurance policy shall be made available to TPCODL prior to first dispatch lot of any Equipment and policy shall be kept alive and valid at all times up to the stage of final acceptance.
- e) TPCODL reserves the right to take out whatever policy that is deemed necessary by him if the associate fails to keep the said policy alive and valid at all times and/or causes lapses in payment of premium thereby jeopardizing the said policy. The cost of such policy(s) shall be recovered / deducted from the amount payable to the associate.
- f) The policy shall ensure that the TPCODL's decision regarding replacement of goods damaged, lost or rendered unusable shall be final.

In all cases, the associate shall lodge the claims with the underwriters and also settle the claims and shall also notify TPCODL of any filed claims. However, the associate shall proceed with the repairs and/or replacement of the equipment/components without waiting for the settlement of the claims. In case of seizure of materials by concerned authorities, the associate shall arrange prompt release against bond, security or cash as required. TPCODL, upon request by the associate, will extend all reasonable assistance to the associate in such a case.

All the insurance claims shall be processed and settled by the associate and the missing/damaged items shall be replaced/repared by them without any extra cost to TPCODL and without affecting the completion time.

28.0 SUGGESTIONS & FEEDBACK

We welcome all our Business Associates to write to us about their experience with TPCODL; be it our Company, our services or our people. Each and every concern, issue, query and suggestion from you will help us to become a better company to work with and shall help us develop a strong bonding of trust and a long term relationship with you.

You may send your feedback by filling up our Business Associate Feedback Form enclosed herewith as *Annexure-E*. You can also log on to our website www.tpcentralodisha.com to provide your feedback.

- Suggestions for us
- Feedback form
- Knowledge Sharing/ Experience with TPCODL
- Any issues with TPCODL.

Submission of feedback form is mandatory before the release of final payment to the BA.

29.0 CONTACT POINTS

In case Business Associate needs information with respect to payments or has any grievances, same may be lodged by log on to our website www.tpcentralodisha.com

30.0 LIST OF ANNEXURES

S. No.	Subject	Annexure
--------	---------	----------

Doc. Title	GENERAL CONDITIONS OF CONTRACT FOR SUPPLY ORDERS	
Rev. No	0	Page 25 of 43

1.	Performa for Bid Security Bank Guarantee	A
2.	Performa for Performance Bank Guarantee (CP cum EP)	B
3.	Performa for No Demand Certificate by Associate	C
4.	Performa For Application For Issuance of Consolidated TDS Certificate	D
5.	Business Associate Feedback Form	E
6.	Acceptance Form For Participation In Reverse Auction Event	F
7.	Form for RTGS Payment	G
8.	Vendor Appraisal Form	H
9.	Manufacturer Authorization Form	I

ANNEXURE-A

PROFORMA FOR BID SECURITY BANK GUARANTEE

**The TP Central Odisha Distribution Limited
Bhubaneswar**

WHEREAS, (Name of the Bidder) _____
(hereinafter called "the BIDDER") has submitted his bid dated _____ for the (Name
of Contract) _____ (hereinafter called "the BID").

Doc. Title	GENERAL CONDITIONS OF CONTRACT FOR SUPPLY ORDERS	
Rev. No	0	Page 26 of 43

KNOW ALL men by these presents we (Name of the Bank) _____ of (Name of the Country) _____ having our registered office at _____ (hereinafter called "the BANK) are bound unto The TP Central Odisha Distribution Limited (TPCODL) in the sum of _____ for which payment well and truly to be made to the TPCODL the Bank binds himself, his successors and assigns by these presents.

SEALED with the Common Seal of the said Bank this _____ day of _____ 20____.

The CONDITIONS of this obligation are:

- i) If the Bidder withdraws his Bid during the period of bid validity specified in the Proforma of Bid or
- ii) If the Bidder having been notified of the acceptance of his Bid by the TPCODL during the period of bid validity fails or refuses to furnish the Contract Performance Bank Guarantee, in accordance with the Instructions to Bidders.

We undertake to pay the TPCODL upto the above amount upon receipt of its first written demand, provided that in its demand the TPCODL will note that amount claimed by it is due to it owing to the occurrence of one or both conditions, specifying the occurred condition or conditions.

This Guarantee will remain in force upto and including the date (No of days as mentioned in tender enquiry) days after the closing date of submission of bids as stated in the Invitation to Bid or as extended by you at any time prior to this date, notice of which extension to the Bank being hereby waived, and any demand in respect thereof should reach the Bank not later than the above date.

DATE **SIGNATURE OF THE BANK**

WITNESS **SEAL**

(Signature, Name & Address) (At least 2 witnesses)

GENERAL CONDITIONS OF CONTRACT

	TP CENTRAL ODISHA DISTRIBUTION LIMITED	
	WORK INSTRUCTION /OPERATING GUIDELINES	
Doc. Title	GENERAL CONDITIONS OF CONTRACT –SUPPLY ORDERS	
Rev. No	0	Page 27 of 43

ANNEXURE- B

PROFORMA FOR PERFORMANCE BANK GUARANTEE (CP cum EP)

(On Rs.100/- Stamp Paper) Note:

- a) Format shall be followed in toto
- b) Claim period of one month must be kept up
- c) The guarantee to be accompanied by the covering letter from the bank confirming the signature to the guarantee

The TP Central Odisha Distribution Limited

Bhubaneswar

CP cum EP BG No.....

Order/Contract No.....dated.....

1. You have entered into a Contract No _____ with M/s. _____ (hereinafter referred to as "the Vendor") for the supply cum erection / civil work of _____ (hereinafter referred to as "the said Equipment") for the price and on the terms and conditions contained in the said contract.
2. In accordance with the terms of the said contract, "the Vendor" agreed to furnish you with an irrevocable, unconditional and acceptable bank guarantee for 10% of the value of contract and to be valid till the end of Guarantee period plus one month towards "Contract cum Equipment performance". For this purpose you have agreed to accept the guarantee.
3. In consideration thereof, we, _____ hereby irrevocably and unconditionally guarantee to pay to you on demand but in any case before the end of five working days from the date of the claim and without demur and without reference to "the Vendor" such amount or amounts not exceeding the sum of Rs. _____ (Rupees _____ only) being _____% (_____ percent) of the total value of the contract on receipt of your intimating that "the Vendor" has not fulfilled his contractual obligations. You shall be the sole judge for such non-fulfillment and "the Vendor" shall have no right to question such judgment.
4. You shall have the right to file / make your claim on us under the guarantee for a **further period of one month** from the date of expiry.
5. This guarantee shall not be revoked without express consent and shall not be affected by your granting time or any other indulgence to "the Vendor", which shall include but not be limited to, postponement from time to time of the exercise the same in you or any right which you may have against "the Vendor" and to exercise the same in any covenant contained or implied in the said contract or any other course or remedy or security available to you, and our Bank shall not be released from its obligations under this guarantee by

Doc. Title	GENERAL CONDITIONS OF CONTRACT FOR SUPPLY ORDERS	
Rev. No	0	Page 28 of 43

your exercising any of your rights with reference to matters aforesaid or any of them or by reasons of any other act or forbearance or other acts of omission or commission on your part or any other indulgence shown by you or by any other matter or thing whatsoever which under the law would, but for this provision have the effect of relieving our bank from its obligation under this guarantee.

6. We also agree that you shall be entitled at your option to enforce this guarantee against our bank as a principal debtor, in the first instance, notwithstanding any other security or guarantee that you may have in relation to "the Vendor's" liabilities in respect of the premises
7. This guarantee shall not be affected by any change in the constitution of our Bank or "the Vendor" or for any other reason whatsoever.
8. Any claim / extension under the guarantee can be lodge-able at outstation banks or at Bhubaneswar branch and claim will also be payable at Bhubaneswar Branch (to be confirmed by Bhubaneswar Branch by a letter to that effect in case BG is from the branch outside Bhubaneswar).
9. Notwithstanding anything herein contained, our liability under this guarantee is limited to Rs. _____ (Rupees _____) only and the guarantee will remain in force upto and including _____ (Date) and shall be extended from time to time for such period or period as may be desired by "the Vendor".
10. Unless a demand or claim under this guarantee is received by us in writing within one months from _____ (expiry date) i.e. on or before _____ (claim period end date), we shall be discharged from all liabilities under this guarantee thereafter.

Dated at _____ this _____ day of _____ 20__

Bank's rubber stamp

1. Banks full address
Designation of Signatory
2. Bank official number

Doc. Title	GENERAL CONDITIONS OF CONTRACT FOR SUPPLY ORDERS	
Rev. No	0	Page 29 of 43

ANNEXURE-C

PROFORMA FOR “NO DEMAND CERTIFICATE” BY ASSOCIATE

(On Company’s Letter head or with Company Seal)

(To be submitted by the Associate to TPCODL Accounts Department at the time of receipt of full and final payment)

(Certificate No. CCP/002)

Name of the Project Order/

Contract No.

Dated

Name of the Associate Scheme

No. / Job No.

We, M/s. _____ (Associate) do hereby acknowledge and confirm that we have received the full and final payment due and payable to us from TPCODL, in respect of our aforesaid Order No _____ dated _____ including amendments, if any, issued by TPCODL to our entire satisfaction and we further confirm that we have no claim whatsoever pending with TPCODL under the said contract / W.O.

Notwithstanding any protest recorded by us in any correspondence, documents, measurement books and / or final bills etc., we waive all our rights to lodge any claim or protest in future under this contract.

We are issuing this “NO DEMAND CERTIFICATE” in favour of TPCODL, with full knowledge and with our free consent without any undue influence, misrepresentation, coercion etc.

Place

Name

(Company Seal)

Doc. Title	GENERAL CONDITIONS OF CONTRACT FOR SUPPLY ORDERS	
Rev. No	0	Page 30 of 43

ANNEXURE-D

**PROFORMA FOR APPLICATION FOR ISSUANCE OF CONSOLIDATED TDS
CERTIFICATE**

To be printed on the letterhead

To,

The TP Central Odisha Distribution Limited,

Bhubaneswar

Sub: Application for issuance of Consolidated TDS Certificate for the FY _____

Dear Sir,

I / we hereby request / authorize you to issue me / us a consolidate TDS Certificate for the financial year _____ against tax deducted at source by you from my / our payments / bills during the said year from time to time under Chapter XVII – B of the Income Tax Act, 1961. For and on behalf of

Signature

Name

Address

Contact No. (Land Line)

(Mobile)

PAN #

Assessing authority

ATTACH THE COPY OF PAN CARD

Doc. Title	GENERAL CONDITIONS OF CONTRACT FOR SUPPLY ORDERS	
Rev. No	0	Page 31 of 43

ANNEXURE-E

BUSINESS ASSOCIATE FEEDBACK FORM

With an objective to improve our internal processes and systems, and serve you better, we solicit your valuable feedback & suggestions. It is estimated that it will take about 10 minutes to complete this survey. We assure you that your feedback shall be kept confidential. Please send the duly filled feedback form in the "TPCODL addressed - attached envelop"

You are associated with us as

- OEMs Service Contractor Material Suppliers Material & Manpower Supplier

You are associated with us for

- Less than 1 year More than 1 year but less than 3 years More than 3 years

Your office is located at

- Bhubaneswar Within 200 kms from Bhubaneswar More than 200 kms from Bhubaneswar

Your nearly turnover with TPCODL

- Less than 25 Lacs 25 Lacs to 1 Crore More than 1 Cr.

Additional Information

Your Name	
Your Designation	
Your Organization	
Contact Nos.	
Email	

We once again thank you for your participation in this survey. Please spare 10 minutes to give your feedback on following pages (Section A to E)

SECTION – A

(Please ✓ mark in the relevant box and give your remarks / suggestions / information for our improvement).

S. No.	Parameters	1	2	3	4	5	Remarks/ Suggestion
		Do Not Agree	Slightly in Agreement	In Fair Agreement	Mostly in Agreement	Fully Agree	
1	You receive all relevant queries / tenders from us in timely manner.						
2	We provide you enough lead time to respond to our queries / tenders.						
3	We provide you adequate support (drawings, documents, clarifications, briefing etc.) to enable you meet our requirements.						
4	All following elements of our contract / purchase order are rational :						
4.1	Scope of Work						
4.2	Delivery / Execution Schedule						
4.3	Payment Terms						
4.4	Liquidated Damages						
4.5	Performance Guarantee						
5	Our purchase orders / contracts are simple, specific & easy to understand						
6	TPCODL demonstrate willingness to be flexible in administration of Contract / Purchase Order						
7	We provide timely responses / clarifications to your queries						
8	TPCODL representative you interact / coordinate with is adequately empowered to support you in meeting contractual obligations						
9	TPCODL provide you all necessary infrastructure support for timely and quality completion of work (including AMC)						
10	TPCODL Engineer-in-Charge timely certifies the jobs executed/ material supplied						
11	TPCODL Engineer-in-Charge efficiently supervises the job execution for timely completion of job						
12	BIRD (Bill Inward Receipt Desk) initiative has improved payment disbursement process						

S. No.	Parameters	1	2	3	4	5	Remarks/ Suggestion
		Do Not Agree	Slightly in Agreement	In Fair Agreement	Mostly in Agreement	Fully Agree	
13	Our approach for Inspection and Quality Assurance effective to expedite project completion?						
14	TPCODL never defaults on contractual terms						
15	In TPCODL Contracts closure is done within set time limit						
16	Our material receiving procedures are well defined and efficiently deployed to reduce mutual inconvenience						
17	Bank Guarantees are released in time bound manner						
18	Our processes related to payment / account settlement are effective.						
19	You get payments on time						
20	TPCODL Employees follow Ethical behaviour						

SECTION – B

SECTION – B (Please rate the following parameters on a scale of 1 to 5, where 1 - Minimum; 5 - Maximum)

S. No.	Parameters	1	2	3	4	5	Remarks/ Suggestion
1	How do you rate courtesy/ empathy/ attitude level and warmth of TPCODL employees you interact with from following team?						
1.1	Project Engineering						
1.2	District / Zones						
1.3	Projects/HOG (TS &P)						
1.4	Inspection & Quality Assurance						
1.5	Stores						
1.6	Metering & Billing						
1.7	Accounts / Finance						
1.8	Administration						
1.9	IT & Automation						
2	How would you rate TPCODL in comparison to your other clients in terms of fairness of treatment and transparency with its Business Associates?						
3	How would you rate TPCODL in comparison to your other clients in terms of processes and systems to manage partnership with its Business Associates						
4	How would you rate TPCODL in comparison to your other clients in terms of building long term & mutually relationship with its Business Associates						

SECTION – C

Please √ mark in the relevant box and give your remarks / suggestions / information for our improvement.

S. No.	Parameters	Certainly No	Probably No	Certainly Yes	Probably Yes	Remarks/ Suggestion
1	Based on your experience with TPCODL, would you like to continue your relationship with TPCODL?					
2	If someone asks you about TPCODL, would you talk "positively" about					

	TPCODL?					
3	Would you refer TPCODL name to others in your community, fraternity and society as a professional & dynamic organization?					

SECTION - D

If we ask you to rate us on a scale of 1 to 10, how will you rate TPCODL, that truly represents your overall satisfaction with us (please tick appropriate box) -

1	2	3	4	5	6	7	8	9	10
---	---	---	---	---	---	---	---	---	----

SECTION - E

Please ✓ mark in the relevant box and give your remarks / suggestions / information for our improvement.

Please spare your thoughts for TPCODL's improvement in particular areas of weaknesses, particularly relating to some great practices, attitudes that you have seen elsewhere in Indian and International Organizations, which you recommend TPCODL to adopt. Please give your valuable salient recommendations.

Please spare your thoughts for TPCODL's improvement in particular areas of major concerns for you. We also welcome your suggestions to adopt any best practices, altitudes that you

Recommendation	<i>Please tick (✓) your top 5 expectations out of the following 10 points listed below -</i>	
(Please list down improvement you expect from TPCODL)	<i>Timely payment</i>	
1	<i>Flexibility in Contracts/PO</i>	
	<i>Clarity in PO,s & Contracts</i>	
2	<i>Timely response to quarries</i>	
	<i>Timely certification of works executed</i>	
3	<i>Clarity in Specs, drawings, other docs etc.</i>	
	<i>Adequate information provided on website for tender notification, parties qualified etc.</i>	
4	<i>Timely receipt of material at site for execution</i>	
	<i>Performance Guarantee/EMD released in time</i>	

Doc. Title	GENERAL CONDITIONS OF CONTRACT FOR SUPPLY ORDERS	
Rev. No	0	Page 36 of 43

5	<i>Inspection & quality assurance support for timely job completion</i>
---	---

We thank you for your time and courtesy!!

ANNEXURE-F

ACCEPTANCE FORM FOR PARTICIPATION IN REVERSE AUCTION EVENT

(To be signed and stamped by the bidder prior to participation in the auction event)

In a bid to make our entire procurement process more fair and transparent, TPCODL intends to use the reverse auctions through SAP-SRM tool as an integral part of the entire tendering process. All the bidders who are found as technically qualified based on the tender requirements shall be eligible to participate in the reverse auction event.

The following terms and conditions are deemed as accepted by the bidder on participation in the bid event:

1. TPCODL shall provide the user id and password to the authorized representative of the bidder. (Authorization Letter in lieu of the same shall be submitted along with the signed and stamped Acceptance Form).
2. TPCODL will make every effort to make the bid process transparent. However, the award decision by TPCODL would be final and binding on the supplier.
3. The bidder agrees to non-disclosure of trade information regarding the purchase, identity of TPCODL, bid process, bid technology, bid documentation and bid details.
4. The bidder is advised to understand the auto bid process to safeguard themselves against any possibility of non-participation in the auction event.
5. In case of bidding through Internet medium, bidders are further advised to ensure availability of the entire infrastructure as required at their end to participate in the auction event. Inability to bid due to telephone line glitch, internet response issues, software or hardware hangs, power failure or any other reason shall not be the responsibility of TPCODL.
6. In case of intranet medium, TPCODL shall provide the infrastructure to bidders. Further, TPCODL has sole discretion to extend or restart the auction event in case of any glitches in infrastructure observed which has restricted the bidders to submit the bids to ensure fair & transparent competitive bidding. In case an auction event is restarted, the best bid as already available in the system shall become the start price for the new auction.
7. In case the bidder fails to participate in the auction event due any reason whatsoever, it shall be presumed that the bidder has no further discounts to offer and the initial bid as submitted by the bidder as a part of the tender shall be considered as the bidder's final no regret offer. Any offline price bids received from a bidder in lieu of non-participation in the auction event shall be out rightly rejected by TPCODL.
8. The bidder shall be prepared with competitive price quotes on the day of the bidding event.
9. The prices as quoted by the bidder during the auction event shall be inclusive of all the applicable taxes, duties and levies and shall be FOR at TPCODL site.
10. The prices submitted by a bidder during the auction event shall be binding on the bidder.
11. No requests for time extension of the auction event shall be considered by TPCODL.
12. The original price bids of the bidders shall be reduced on pro-rata basis against each line item based on the final all inclusive prices offered during conclusion of the auction event for arriving at Contract amount.

Signature & Seal of the Bidder

Doc. Title	GENERAL CONDITIONS OF CONTRACT FOR SUPPLY ORDERS	
Rev. No	16	Page 38 of 43

Name of the Authorized Signatory: _____ :

Contact Person's Name:

Official Correspondence Address:

We confirm that we will bear the charges, if any, levied by our bank for the credit of NEFT/RTGS amounts in our account. Any change in above furnished information shall be informed to TPCODL well in time at our own. Further, we kept TPCODL indemnified for any loss incurred due to wrong furnishing of above information.

Thanking you,

For _____

(Authorised Signatory)

(Signature with Rubber Stamp)

Certification from Bank:

We confirm that we are enabled for receiving NEFT/RTGS credits and we further confirm that the account number (specify Bank a/c no.) of (Please mention here name of the account holder), the signature of the authorised signatory and the MICR and IFSC Code of our branch mentioned above are correct.

This also is certified that the above information is correct as per Bank record

(Manager's/ Officers Signature under Bank Stamp)

ANNEXURE-H
VENDOR APPRAISAL FORM

TO BE SUBMITTED BY VENDOR (To be filled as applicable)			
VENDOR:			
1.0	DETAILS OF THE FIRM		
	1.1	NAME (IN CAPITAL LETTERS)	:
	1.2	TYPE OF CONCERN (PROPRIETARY) Partnership, Pvt. Ltd., Public Ltd. etc.	:
	1.3	YEAR OF ESTABLISHMENT	:
	1.4	LOCATION OF OFFICE POSTAL ADDRESS TELEGRAPHIC ADDRESSES, TELEX NO. FAX NO.	:
	1.5	LOCATION OF MANUFACTURING UNITS	:
		i) UNITS 1	:
		ii) OTHER UNITS	:
2.0	PRODUCTS MANUFACTURED		
3.0	TURNOVER DURING THE LAST 3 YEARS (TO BE VERIFIED WITH THE LATEST PROFIT & LOSS STATEMENT).		
4.0	VALUE OF FIXED ASSETS		
5.0	NAME & ADDRESS OF THE BANKERS		
6.0	BANK GUARANTEE LIMIT		
7.0	CREDIT LIMIT		
8.0	TECHNICAL		
	8.1	NO. OF DESIGN ENGINEERS (INDICATE NO. OF YEARS EXPERIENCE IN RELATED FIELDS)	:
	8.2	NO. OF DRAUGHTS MEN	:
	8.3	COLLABORATION DETAILS (IF ANY)	:
		8.3.1 DATE OF COLLABORATION	:
		8.3.2 NAME OF COLLABORATOR	:
		8.3.3 RBI APPROVAL DETAILS	:
		8.3.4 EXPERIENCE LIST OF COLLABORATOR	:
		8.3.5 DURATION OF AGREEMENT	:
	8.4	AVAILABILITY OF STANDARDS / DESIGN PROCEDURES / COLLABORATOR'S /	:

Doc. Title	GENERAL CONDITIONS OF CONTRACT FOR SUPPLY ORDERS	
Rev. No	16	Page 40 of 43

		DOCUMENTS (CHECK WHETHER THESE ARE LATEST/CURRENT)	
	8.5	TECHNICAL SUPPORT, BACK-UP GUARANTEE, SUPERVISION, QUALITY CONTROL BY COLLABORATOR (WHEREVER ESSENTIAL). (THIS CLAUSE IS RELEVANT WHEN VENDOR'S EXPERIENCE IS INADEQUATE)	:
	8.6	QUALITY OF DRAWINGS	:
9.0	MANUFACTURE		
	9.1	SHOP SPACE, LAYOUT LIGHTING, VENTILATION, ETC.	:
	9.2	POWER (KVA)	:
		MAINS INSTALLED	:
		UTILIZED	:
		STANDBY POWER SOURCE	:
	9.3	MANUFACTURING FACILITIES (ATTACH LIST OF EQUIPMENT AS APPLICABLE)	:
		9.3.1 MATERIAL HANDLING	:
		9.3.2 MACHINING	:
		9.3.3 FABRICATION	:
		9.3.4 HEAT TREATMENT	:
		9.3.5 BALANCING FACILITY	:
		9.3.6 SURFACE TREATMENT PRIOR TO PAINTING/ COATING, POLISHING, PICKLING, PASSIVATION, PAINTING, ETC.	:
	9.4	SUPERVISORY STAFF	:
	9.5	ADEQUACY OF SKILLED LABOURS (MACHINISTS, WELDERS, ETC.)	:
	9.6	NO. OF SHIFTS	:
	9.7	TYPE OF MATERIAL HANDLED (SUCH AS CS, SS, ETC.)	:
	9.8	WORKMANSHIP	:
	9.9	MATERIAL IN STOCK AND VALUE	:
	9.10	TRANSPORT FACILITIES	:
	9.11	CARE IN HANDLING	:
10.0	INSPECTION / QC / QA / TESTING		
	10.1	NUMBER OF PERSONNEL (INDICATE NO. OF YEARS OF EXPERIENCE)	:
	10.2	INDEPENDENCE FROM PRODUCTION	:

Doc. Title	GENERAL CONDITIONS OF CONTRACT FOR SUPPLY ORDERS	
Rev. No	16	Page 41 of 43

	10.3	AVAILABILITY OF PROCEDURAL WRITE UP/QUALITY PLAN	:
	10.4	INCOMING MATERIAL CONTROL AND DOCUMENTATION	:
	10.5	RELIABILITY/REPUTATION OF SUPPLY SOURCES	:
	10.6	STAGE INSPECTION AND DOCUMENTATION	:
	10.7	SUB-ASSEMBLY & DOCUMENTATION	:
	10.8	FINAL INSPECTION AND DOCUMENTATION	:
	10.9	PREPARATION OF FINAL DOCUMENTATION PACKAGE	:
	10.10	TYPE TEST FACILITIES	:
	10.11	ACCEPTANCE TEST FACILITIES	:
	10.12	CALIBRATION OF INSTRUMENTS AND GAUGES (WITH TRACEABILITY TO NATIONAL STANDARDS) (ATTACH LIST)	:
	10.13	STATUTORY APPROVALS LIKE BIS, IBR, ETC.(AS APPLICABLE)	:
	10.14	SUB-VENDOR APPROVAL SYSTEM AND QUALITY CONTROL	:
	10.15	DETAILS OF TESTS CARRIED OUT AT INDEPENDENT RECOGNIZED LABORATORIES	:
		i) FURNISH LIST OF TESTS CARRIED OUT AND THE NAME OF THE LABORATORY WHERE THE TESTS WERE CONDUCTED	:
		ii) CHECK AVAILABILITY OF CERTIFICATES AND REVIEW THESE WHEREVER POSSIBLE	:
	11.0	EXPERIENCE (INCLUDING CONSTRUCTION / ERECTION / COMMISSIONING) TO BE FURNISHED IN THE FORMAT INDICATED IN APPENDIX)	:
	12.0	SALES, SERVICE AND SITE ORGANIZATIONAL DETAILS	:
	13.0	CERTIFICATE FROM CUSTOMERS (ATTACH COPIES OF DOCUMENTS)	:
	14.0	POWER SITUATION	:
	15.0	LABOUR SITUATION	:
	16.0 *	APPLICABILITY OF SC/ST RELAXATION (Y/N) IF YES, SUPPORTING DOCUMENTS TO BE ATTACHED	
	17.0	ORGANIZATIONAL DETAILS 1. PF NO 2. ESI NO 3. INSURANCE FOR WORK MAN COMPENSATION ACT NO 4. ELECTRICAL CONTRACT LIC NO 5. ITCC / PAN NO 6. SALES TAX NO 7. WC TAX REG. NO	:
	18.0	DOCUMENTS TO BE ENCLOSED:	

Doc. Title	GENERAL CONDITIONS OF CONTRACT FOR SUPPLY ORDERS	
Rev. No	16	Page 42 of 43

	<ol style="list-style-type: none"> 1. FACTORY LICENSE 2. ANNUAL REPORT FOR LAST THREE YEARS 3. TYPE TEST REPORT FOR THE ITEM 4. PAST EXPERIENCE REPORTS 5. ISO CERTIFICATE –QMS, EMS, OHAS, SA 6. REGISTRATION OF SALES TAX 7. COPY OF TIN NO. 8. COPY OF SERVICE TAX NO. 9. REGISTRATION OF CENTRAL EXCISE 10. COPY OF INCOME TAX CLEARANCE. 11. COPY OF PF REGISTRATION 12. COPY OF ESI REGISTRATION 13. COPY OF INSURANCE FOR WORK MAN COMPENSATION ACT NO 14. COPY OF ELECTRICAL CONTRACT LIC NO 15. COPY OF PAN NO 16. COPY OF WC TAX REGISTRATION 17. DOCUMENTS IN SUPPORT OF SC/ST RELAXATION AT S.NO.16.0 18. GSTN CERTIFICATE 	
--	--	--

*** Classification of BA s under SC/ST shall be governed under following guidelines:**

- **Proprietorship/ Single Ownership Firm:** Proprietor of the firm should be from SC/ST community. Governing document shall be Proprietorship Deed.
- **Partnership Firm:** Only such firms shall qualify which have SC/ST partners holding equal to or more than 50% of the total ownership pattern of the firm. Governing document shall be Partnership Deed.
- **Private Limited Company:** Only such firms shall qualify which have SC/ST directors holding equal to or more than 50% of the total ownership pattern of the firm. Governing document shall be Memorandum of Understanding (MoU) and/or Article of Association (AoA).

NOTE: Certification from SC/ST Commission shall be required for deciding upon SC/ST status of a person.

Doc. Title	GENERAL CONDITIONS OF CONTRACT FOR SUPPLY ORDERS	
Rev. No	16	Page 43 of 43

ANNEXURE-I
MANUFACTURER AUTHORIZATION FORM

(To be submitted on OEM's Letter Head)

Date:

Tender Enquiry No.:

To,
Chief (Procurement & Stores)
The TP Central Odisha Distribution Limited,
Bhubaneswar

Sir,

WHEREAS M/s. *[name of OEM]*, who are official manufacturers of having factories at *[address of OEM]* do hereby authorize M/s *[name of bidder]* to submit a Bid in relation to the Invitation for Bids indicated above, the purpose of which is to provide the following Goods, manufactured by us

.....and to subsequently negotiate and sign the Contract.

We hereby extend our full guarantee and warranty in accordance with the Special Conditions of Contract or as mentioned elsewhere in the Tender Document, with respect to the Goods offered by the above firm in reply to this Invitation for Bids.

We hereby confirm that in case, the channel partner fails to provide the necessary services as per the Tender Document referred above, M/s *[name of OEM]* shall provide standard warranty on the materials supplied against the contract. The warranty period and inclusion / exclusion of parts in the warranty shall remain same as defined in the contract issued to their channel partner against this tender enquiry.

Yours Sincerely,

For

Authorized Signatory

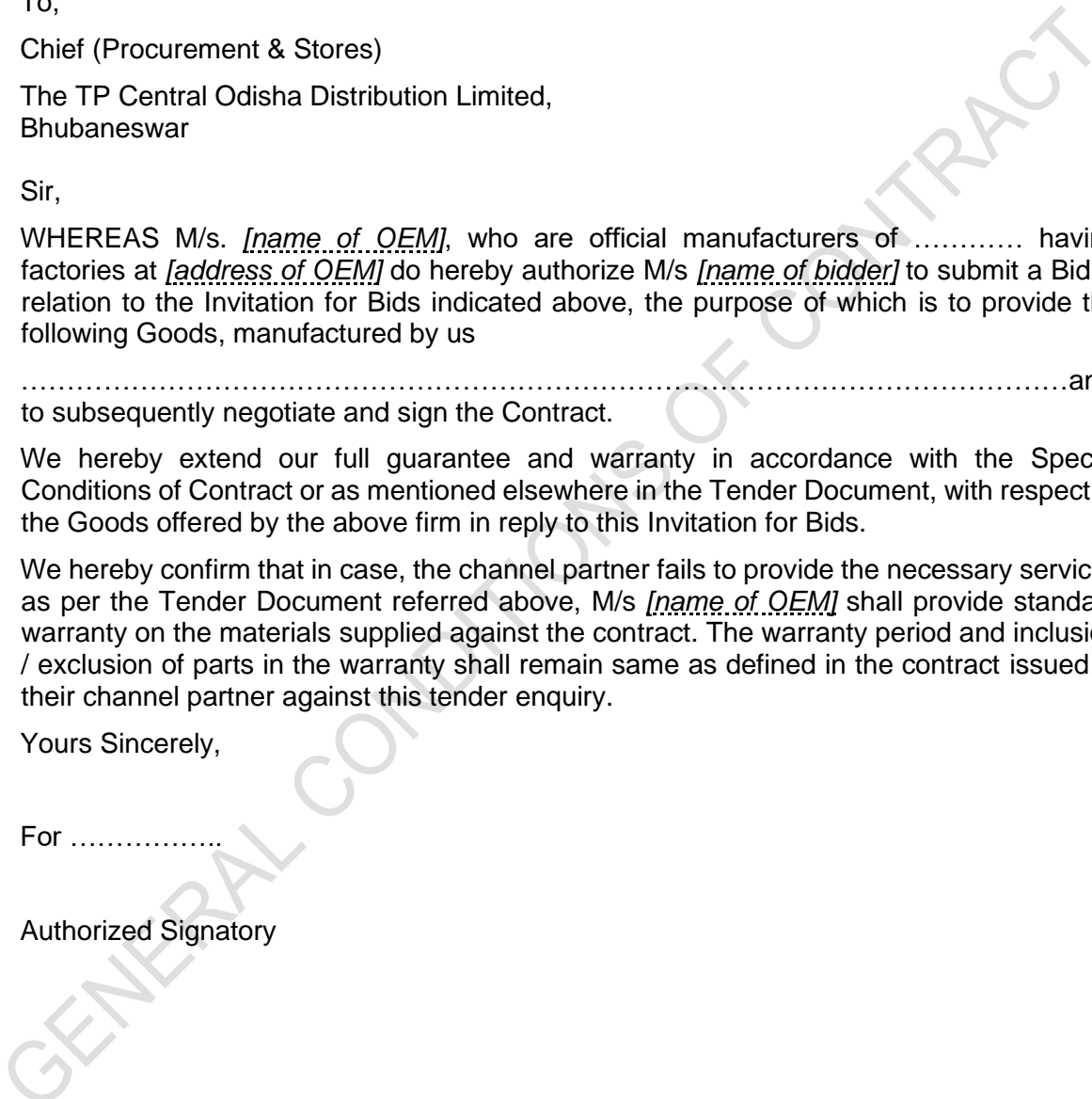

Annexure VIII

Safety Policy and Safety Terms and Conditions

The Tata Power Company Ltd	TPCODL TPSODL	 TATA TATA POWER	TPNODL TPWODL	<i>Contractor's Safety Code of Conduct</i>
<i>Document no TPSMS/GSP/ CSM/015/REV 07</i>				<i>Date of Issue: 01/08/2023</i>

Contractor's Safety Code of Conduct

Reason for Change	Date of Last Revision	Prepared By	Reviewed By	Approved by
Inclusion of Odisha Discom and periodic Revision	<u>11-May-2015-</u> <u>R1</u> <u>15 August-2021-</u> <u>R6</u>	All Discom and CFT members from all cluster	Debi Prasad Acharya (Head-Safety-Odisha Discom)	Suresh H Khetwani <i>(Chief safety and Environment)</i>

The Tata Power Company Ltd	     	Contractor's Safety Code of Conduct
Document no TPSMS/GSP/ CSM/015/REV 07		Date of Issue: 01/08/2023

CONTENTS

Clause	Sub-clause	Description	Page No
1.0		Objectives	4
2.0		Scope	4
3.0		Definitions	4
	3.1	Order Manager (Engineer in Charge)	4
	3.2	Site Safety Management Plan	4
	3.3	Contractor / Business Associate/Vendor (BA)	4
	3.4	Emergency	4
	3.5	Expert service job	4
	3.6	CEO/Chief/Head of division/Unit/Utility	5
	3.7	Category A Vendor	5
	3.8	Category B Vendor	5
	3.9	Category C Vendor	5
	3.10	Category D Vendor	5
	3.11	High Risk Jobs	5
	3.12	Medium Risk Jobs	5
	3.13	Low Risk jobs	5
	3.14	Long Duration jobs	5
	3.15	High Value Jobs	5
	3.16	<i>Strategic Business Unit-SBU/Division/Discom-R7</i>	5
4.0		Responsibilities	6
	4.1	Order Manager / Engineer In Charge	6
	4.2	Contractor	6
	4.3	Safety Concurrence Group (SCG)	7
5.0		Procedure	7
	5.1	Registration of Business Associate (Vendor)	7
	5.2	Bid Evaluation	8
	5.3	Capability Building	9
	5.4	Recognition to prior learning in Safety	10
	5.5	Safety performance retention	10
	5.6	Safety Performance Evaluation	11

APPENDICES-R7

Appendix No.	Description	Page No.
1	CSM F1 – Process Flow Chart for Vendor Registration	12
2	CSM F2 – Safety Category Qualification Form	13
3	CSM F3 – Safety Terms and Conditions	16

4	CSM F4– Safety Potential Evaluation Criteria for vendor registration	16
5	CSM F5 – Flow Chart for Issuing RFQ and PO	18
6	CSM F6 – Safety Competency Assessment Form	19
7	CSM F7 – Safety Bid Evaluation Criteria	23
8	CSM F8 – PPE Requirements	27
9	CSM F9– Site Safety Management Plan	30
10	CSM F10 – Process Flow Chart for Safety Performance Evaluation	35
11	CSM F11– Safety Performance Evaluation Criteria	36
12	CSM F12 – Safety Violation Penalty Criteria	38
13	CHECKLIST TO BE USED DURING SITE VISIT	42
14	Indicative List of High-Risk Jobs	43

CONFIDENTIAL

The Tata Power Company Ltd		Contractor's Safety Code of Conduct
Document no TPSMS/GSP/ CSM/015/REV 07		Date of Issue: 01/08/2023

1.0 Objective

- The Tata Power engages contractor workforce to execute, run and maintain various operating sites and facilities across locations for various business verticals including Generation, Transmission, Distribution and Renewable. The activities range from project execution, operation, maintenance to facilities management.
- The management of contractor safety represents a significant challenge for management. Tata Power has a responsibility to ensure that contractors are provided with enough information and support to enable them to conduct their roles safely and without endangering health and safety of their own workforce or that of our staff.

2.0 Scope:

- This procedure applies to all operating and project sites of The Tata Power Company Ltd and Group companies including new businesses like Electric Vehicle charging, Home Automation, Microgrid, Roof top solar etc. *This Code of Conduct also applies to all operating and project sites of four Odisha Discoms and New business based on mutually agreed timeline for implementation. R7*
- *This document is applicable to Odisha Discoms also. Odisha Discoms are a joint venture between Tata Power and the Government of Odisha with the majority stake being held by Tata Power Company (51%). ODISHA DISCOMS is a state electricity distribution utility with sole rights to distribution of electricity in the Odisha covering the distribution companies such as TPNODL, TPCODL, TPSODL and TPWODL. In accordance with the Electricity Act. ODISHA DISCOMS engages contractor workforce to execute, run and maintain various operating sites and facilities across locations The activities range from project execution, operation & maintenance of facilities. (R7)*

3.0 Definitions

- 3.1. **Order Manager/Engineer in charge:** Order Manager/Engineer in charge is the Tata Power-Division /DISCOM representative, who has the ownership of the given job.
- 3.2. **Site Safety Management Plan:** It is the safety plan agreed between Contractor and Tata Power-Division/DISCOM. It will contain the entire job specific safety requirement and will be signed by the contractor.
- 3.3. **Contractor/Business Associate/Vendor (BA):** An individual or a company that provides services to Tata Power-Division/DISCOM under a signed contract.
- 3.4. **Emergency:** It is a serious, unexpected, or dangerous situation requiring immediate action, which may result in *loss of life*, loss of revenue/property, business discontinuity. In case of Emergency, services may be procured by selecting the qualified vendor based on the vendor category without the safety bid evaluation and approved by adequate authority of MB level or above.
- 3.5. **Expert Service jobs:** Jobs which needs expert services of contractor which does not involve direct exposure to the potential risk or work which involves only

The Tata Power Company Ltd	  	Contractor's Safety Code of Conduct
Document no TPSMS/GSP/ CSM/015/REV 07	  	Date of Issue: 01/08/2023

supervisory work such as expert for AI-ML, expert for transmission and distribution network, expert for civil works, expert on transformers, expert for PSCC, expert for equipment overhaul etc.

- 3.6. **CEO/Chief/Head of division/Unit/Utility:** Business in charge who is overall custodian of the Tata Power-Division/DISCOM.
- 3.7. **Category A Vendor:** Vendor eligible to carry out Very High & High risk (as per Tata Power-Division Hazard Identification and Risk Analysis Procedure) and /or Long-Term Contract related to operation and maintenance (O&M) of plant. Vendors must fulfil the requirement specified for Category A in Appendix 4-CSMF-4 of this document.
- 3.8. **Category B Vendor:** Vendors eligible to carry out technical jobs, that are classified under Medium / low risk. Vendors must fulfil the requirement specified for Category B in Appendix 4-CSMF-4 of this document.
- 3.9. **Category C Vendor:** Vendors eligible for to carry out low or very low risk administrative and office jobs. For this he must fulfil the requirement specified for Category C in Appendix 4-CSMF-4 of this document.
- 3.10. **Category D Vendor:** All Consultants, Medical Practitioners or vendors taking job from Tata Power and working from their own premises (e.g., motor rewinding at vendor's shop floor, equipment sent for repair to vendor's works etc.) are classified as Category D Vendor.
- 3.11. **High Risk Jobs:** A Job or its activities are considered as Very High or High Risk when Order manager apply the "Tata Power Hazard Identification and Risk Analysis" procedure and found safety risk associated with are under Very High or High category. Indicative lists of jobs are given in appendix 14 of this document.
- 3.12. **Medium Risk Jobs:** Jobs or its activities are considered as medium risk when Order manager apply "Tata Power Hazard Identification and Risk Analysis" procedure and found the same as Medium Risk.
- 3.13. **Low Risk Jobs:** Any job or its activities are considered as Low or Very low risk while Order manager calculated it by applying "Tata Power Hazard Identification and Risk Analysis" procedure and found it under Low or Very Low category.
- 3.14. **Long Duration Jobs:** *When the duration of job is more than 12 months, it is considered as long duration job. R7*
- 3.15. **High Value Jobs:** When the value of the job contract is Rs. One Crore or more, it is considered as High value job.
- 3.16. **Strategic Business Unit-SBU/Division/Discom:** *A strategic business unit is a fully functional, independently operational setup of a particular business and an important part of the Tata power company. R7*

The Tata Power Company Ltd	     	Contractor's Safety Code of Conduct
Document no TPSMS/GSP/CSM/015/REV 07		Date of Issue: 01/08/2023

4.0 Responsibilities

4.1 Order Manager/Engineer in Charge: Order Manager is Tata Power-Division /DISCOM representative, who is responsible for:

- 4.1.1 Finalizing the Site Safety Management Plan along with Contractor, Safety Concurrences Group, Divisional Safety Head and Expert (External or Internal) if required.
- 4.1.2 Ensure 100% safety capability building L1, L2, L3 for contractor work force and supervisor before start of Job
- 4.1.3 Ensure Contractor safety revalidation test for all work force quarterly or Half yearly for new business such as Odisha Discom (R7).
- 4.1.4 Conduct competency assessment of all critical work force working on High-Risk Jobs based on Experience, Technical skill and Safety capability through contractor representative along with division/Discom safety representative. R7
- 4.1.5 Supervise and ensure work is carried out as per the Site Safety Management Plan including agreed Risk Assessment (HIRA/JSA) and Method Statement.
- 4.1.6 Conduct audit and evaluate Safety Performance of contractor.
- 4.1.7 Ensure contractors adhere to all statutory provisions.
- 4.1.8 In case any Exception needed in agreed safety management plan or in CSCC process for execution of job, document control procedure- TPSMS/GSP/DC/014 Clouse 6.3 will be applicable, and approval may be obtained by the Order Manager from adequate authority of Chief of Division/CEO of Discom. (R7)

4.2 Contractor/Business Associate/Vendor (BA): The person, entity or organisation who is executing the job for Tata Power-Division /Odisha Discoms under a contractual agreement and will be responsible for the following

- 4.2.1 To follow all Tata Power-Division /DISCOM Critical Safety Procedure, Rules and guidelines given in **CSM F3 Safety Terms and Conditions.**
- 4.2.2 Undertake job as per **CSM F9 Site Safety Management Plan** and method statements agreed with the Tata Power-Division /DISCOM.
- 4.2.3 Ensure 100% safety capability building L1, L2, L3 for contractor work force and supervisor before start of Job
- 4.2.4 Ensure Contractor safety revalidation test for all workforce quarterly or Half yearly for new business such as Odisha Discom up to three years. R7.
- 4.2.5 Ensure competency assessment of all critical work force working on High-Risk Jobs based on Experience, Technical skill and Safety capability through Order manager or Engineer in charge representative along with division/Discom safety representative. R7
- 4.2.6 Raise any concerns about their work and its safety with the Order Manager.

The Tata Power Company Ltd	    	Contractor's Safety Code of Conduct
Document no TPSMS/GSP/ CSM/015/REV 07		Date of Issue: 01/08/2023

- 4.2.7 Report all injuries, near misses, unsafe acts/conditions, and occurrences to the Order Manager immediately.
- 4.2.8 Ensure that all sub-contractors follow the Tata Power Safety Procedure and agreed **CSM F9 Site Safety Management Plan**. If subcontractor detail is not available at stage of Bid evaluation, then this can be agreed with Order manager or Engineer in charge before deployment. Ensure that all sub-contractors follow the Tata Power Safety Procedure and agreed CSM F9 Site Safety Management Plan.**R7**
- 4.2.9 To follow all statutory requirements as per the laws of the land.
- 4.2.10 All vendors applying for category "A" jobs or submitting quote for high-risk jobs shall obtain certificates of ISO:9001, ISO:14001 and ISO:45001 before submitting quote for high-risk Jobs or otherwise mention plan to get the certification. **R7**
- 4.3 Safety Concurrence Group (SCG):** It is Cross Functional Team constituted by Contract department with active support from Safety Team of the Tata Power Division/Discom safety team having representatives from Execution Department, Operation Department, Contract Department, and any other department as deemed fit. SCG will be responsible for the following:
- 4.3.1 Assessment of Safety Potential of new vendor before registration using **CSM F1 Process Flowchart for Vendor Registration** and **CSM F2 Safety Category Qualification Form**.
- 4.3.2 Safety Evaluation of the bids as per evaluation format **CSM F7 Safety Bid Evaluation Criteria**
- 4.3.3 Finalization of the **CSM F9 Site Safety Management Plan** submitted by the contractor.
- 4.3.4 During Safety Bid Evaluation for following types of jobs are evaluated: R7
- 4.3.4.1 High-Risk jobs, Medium Risk job, Major Shutdowns and Outages.
- 4.3.4.2 Capex jobs of High-Risk Category

5.0 Procedure

5.1 Registration of Business Associates (Vendors)

For Vendor Registration, Contract Department will issue following documents for evaluation of contractor's safety capability

- 1) **CSM F2 Safety Category Qualification Form**
- 2) **CSM F3 Safety Terms and Conditions**

The document **CSM F3 Safety Terms and Conditions** provides the information about Tata Power-Division /Odisha Discom safety System to the contractor. Contractor will submit the **CSM F2 Safety Category Qualification Form** with all relevant details and documents to Vendor Registration Initiator, which will in turn forward it to Safety Concurrence Group (SCG) for evaluation. The SCG will evaluate the details submitted by the contractor based

The Tata Power Company Ltd	     	Contractor's Safety Code of Conduct
Document no TPSMS/GSP/ CSM/015/REV 07		Date of Issue: 01/08/2023

on a predetermined criteria **CSM F4 Safety Potential Evaluation Criteria** for Vendor Registration and will determine the category (Category A/B/C/D) for which the contractor will be registered. As mentioned in the above criteria, a site visit may also be organized by SCG prior to registration under Category A and B. In case, the contractor does not qualify the safety criteria, the contractor will not be registered. However, he may apply afresh for registration after 6 months. Please refer **Appendix 1: CSM F1 Process Flow Chart for Vendor Registration.**

5.2 Bid evaluation

At the time of placing the Purchase Requisition (PR), Order Manager is required to declare the risk involved in the of the job (i.e., High Risk / Medium Risk / Low Risk jobs, based on the RPN in HIRA). If the Job is "High /Medium Risk" then RFQ will be attached with following documents:

- 1) **CSM F3 Safety Terms and Conditions**
- 2) **CSM F6 Safety Competency Assessment Form**
- 3) **CSM F8 PPE requirements**
- 4) **CSM F9 Site Safety Management Plan Job Specific Safety Requirement (Educational and Professional Qualification, Skill & Experience Manpower, Tools, and Tackles, e.g., man lifter, use of drone, use & availability of rescue kit, Work Methodology etc.)**

Otherwise the RFQ will be attached only with **CSM F3 Safety Terms and Conditions.** Contracts department will collect duly filled **CSM F6 Safety Competency Form** along with the bid. All other stakeholders will also put their efforts to get all relevant safety data during meeting / discussions with the vendor. SCG will evaluate the document as per the **CSM F7 Safety bid evaluation criteria.** If any specific condition related to Contract is required to be conveyed to the contractor, Site safety team will attach the same as Annexure for specific conditions of job and submit it to contract team along with safety bid evaluation form. Commercial bid of contractor will be considered for evaluation by contract team only if contractor is qualified in safety bid. Site Safety Management Plan, defining the complete procedure of executing the job at site will be signed by the contractor and SCG after mutual agreement. Contract will attach a copy of Site Safety Management Plan along with PO to the successful bidder. Please refer **CSM F5 Process Flow Chart for issuing RFQ and PO significant health and safety risk associated with it.**

5.3 Capability Building:

Before issuing gate pass:

For Odisha Discom: All Tata Power contractor and subcontractor workforce is required to

The Tata Power Company Ltd		Contractor's Safety Code of Conduct
Document no TPSMS/GSP/ CSM/015/REV 07		Date of Issue: 01/08/2023

attend Site Safety Orientation Training to receive a Safety Training Card, which is required to obtain a Gate Pass to the site, prior to entry. This Safety Orientation Course will be for duration of minimum half day. The information provided during the orientation will include, but is not limited to Job rules, personal safety, and conduct, Hazard's reporting, reporting of injuries, Emergency procedures, Safety Activities and Program including disciplinary measure and incentives, Critical safety procedure relevant to the job

For Tata Power Divisions: All Tata Power contractor and subcontractor workforce is required to attend L1 Training to receive a Safety Training Card, which is required to obtain a Gate Pass to the site, prior to entry.

For TataPower and Discom: Appropriate practical training such as SHE L1, L2& L3 is given to ensure that a jobholder, either supervisor or worker, is competent to do his/her job safely. The skill training is provided through TPSDI, and other agencies authorized by Tata Power on the list of 15 critical Safety procedures mentioned under safety procedures. Duration of course is as specified by Division/Discom. Contractor shall ensure that concerned workmen are provided with adequate training before he/she is allowed to execute the work. An evaluation test will be conducted after the completion of the training. Those BA employees, who meet the minimum required competency, will be provided with Certificate or Training /Competency Card, which is valid for 3 years, post which the employee must reappear for the assessment. If the workman is not able to qualify the assessment, he/she will be given 3 additional attempts to clear in 3-month time frame failing which he/she will not be allowed to work on Division/Discom any jobs. After expiry of Certificate or Training /Competency Card again one day recertification of L1, L2 and L3 skill training will be provided. R7.

The Contactor shall bear the conveyance and food expenses of his staff for attending training sessions and capability building sessions in new business-like Odisha Discom.

The Contactor shall bear the entire cost of L1/L2/L3, the costs towards training, salaries/wages, boarding and lodging of his staff for attending training sessions and capability building sessions. These trainings are offered on nominal chargeable basis payable by Contractor and rates shall be decided by TPSDI from time to time in case of training trough TPSDI. Generally, L0 is of one day, L1 is for 2 days for each critical procedure and L3 is for one day. Around Rs 700+GST is approx. cost /Day/Candidate. - R7

All contractors' workmen and Business Associate must attend Safety foundation course Training, all workmen engaged in critical jobs must clear and get certified for critical procedures applicable on his work like Work at Height and Electrical safety-LT & HT/LOTO&LC separately and all supervisors must complete supervisor certification in safety.

The Tata Power Company Ltd	    	Contractor's Safety Code of Conduct
Document no TPSMS/GSP/ CSM/015/REV 07	TATA POWER	Date of Issue: 01/08/2023

Competency assessment of all critical workforce to be carried out for all who has taken L2 training. R7

5.4 Recognition to the Prior Learning in Safety-R7

If "Order Manager" recommends and "Head of the Safety Department of Discom" is satisfied with the safety knowledge and competency of the employee of contractor, a test may be conducted by Tata power Skill development Institute/ other recognized institute to assess the prior learning in safety. If employees of the contractors pass in such test, he will be exempted from appearing in SHE L1 training. This assessment is on nominal chargeable basis and rates are decided by TPSDI from time to time.

5.5 Safety performance retention(R7): A certain percentage of the bill value will be retained against every running bill as safety performance retention. The amount will be released with the last invoice or every six-month based on Safety Performance Score of contractors. The retention amount will be calculated based on contract value as below. (R7)

Risk Category-(R7)	Contract Value	Retention Amount (%)
<u>Very high/High risk job/ Medium Risk jobs</u>	Up to 10 Lakhs	2.5
<u>Very high/High risk job/ Medium Risk jobs</u>	10 – 50 Lakhs	2
<u>Low/Very Low Risk jobs</u>	10 – 50 Lakhs	1
<u>Very high/High risk job</u>	0.5 to 10 Cr	2
<u>Medium Risk jobs</u>	0.5 to 10 Cr	1.5
<u>Low/Very Low Risk jobs</u>	0.5 to 10 Cr	1
<u>Very high/High risk job</u>	>10 Cr	1.5
<u>Medium Risk jobs</u>	>10 Cr	1

- The safety retention amount will not be applicable if there is clause of Contract Performance Bank Guarantee (CPBG) and safety performance of contractor is as per desired criteria.
- If safety performance of contractor is not as per desired criteria (as per Appendix 10 – CSM F10 – Process Flow Chart for Safety Performance Evaluation and Appendix 11: CSM F11 - Safety Performance Evaluation Criteria- R7.) then safety retention percentage as mentioned in table above will be deducted from running bill.
- Bidder to give understanding that if there are any deductions required to be made for safety non-performance as per the Safety Performance Score, then Tata Power shall recover any such deductions against safety non-performance directly from the monthly bills / final settlement or it shall be within its right to recover such sum from accounts payable or the CPBG or the retention of the Contractor available with Tata Power for the said contract between the Contractor and Tata Power. R7

The Tata Power Company Ltd	    	Contractor's Safety Code of Conduct
Document no TPSMS/GSP/ CSM/015/REV 07		Date of Issue: 01/08/2023

For all other contracts retention amount is applicable as per table given above.

4. The retention amount against non-safety performance saved and Penalty will go to a separate Safety Improvement Fund.R7
5. For the contract value of more than Rs 1 Cr or contract duration more than 12 months, the retention amount shall be released half yearly based on safety performance. For all remaining contracts, the retention amount will be released with the final bill.
6. Safety performance bonus 1% (limiting to 50 lakhs) of the invoice value will be considered at the end of the job if the contractual safety performance score is 100%.

5.6 Safety Performance Evaluation:

During the time of job execution, regular site inspection will be carried out by the Tata Power-Division /DISCOM officials to evaluate monthly safety performance of the contractor as per **CSM F11 Safety Performance Evaluation Report** and monthly score will be maintained by the Order Manager. Violations will be dealt as per **CSM F12 Safety Violation Penalty Criteria**. Please refer **CSM F10 Process Flow Chart for Safety Performance Evaluation**. Percentage of retention amount is usually mentioned in safety terms and conditions.

1. During the progress of the work, concerned site Supervisor/Engineer/Safety representative will visit and inspect the work site regularly and evaluate the safety performance of the contractor based on matrix **Appendix 13** and apply the Consequence management policy/Penalty criteria as applicable.
2. The evaluation criteria include Lead Indicators such as percentage of workers trained in TPSDI, inspection of critical equipment. Lag indicators such as Fatalities, LWDC and man-days lost.
3. In case of job stoppage due to safety violations / unsafe observations at the site, no time extension from PO completion date shall be given to the contractor, if such delays are attributable to contractor.
4. In case of fatality, limb loss or loss of property, vendor must pay for liability, legal, statutory, and additional mutually agreed settlement charges imposed by the appointed committee by Division Chief/CEO. This charge is over and above the retention amount. The committee will finalize penalty amount based on factors such as advice by statutory authorities, contract value and impact of accident etc.
5. Order Manager, Head of Business and functional Chief have the authority to terminate the contract as per **CSM F12 Safety Violation Penalty Criteria** Through contract department.

Appendix 1: CSM F1 - Process Flow Chart for Vendor Registration

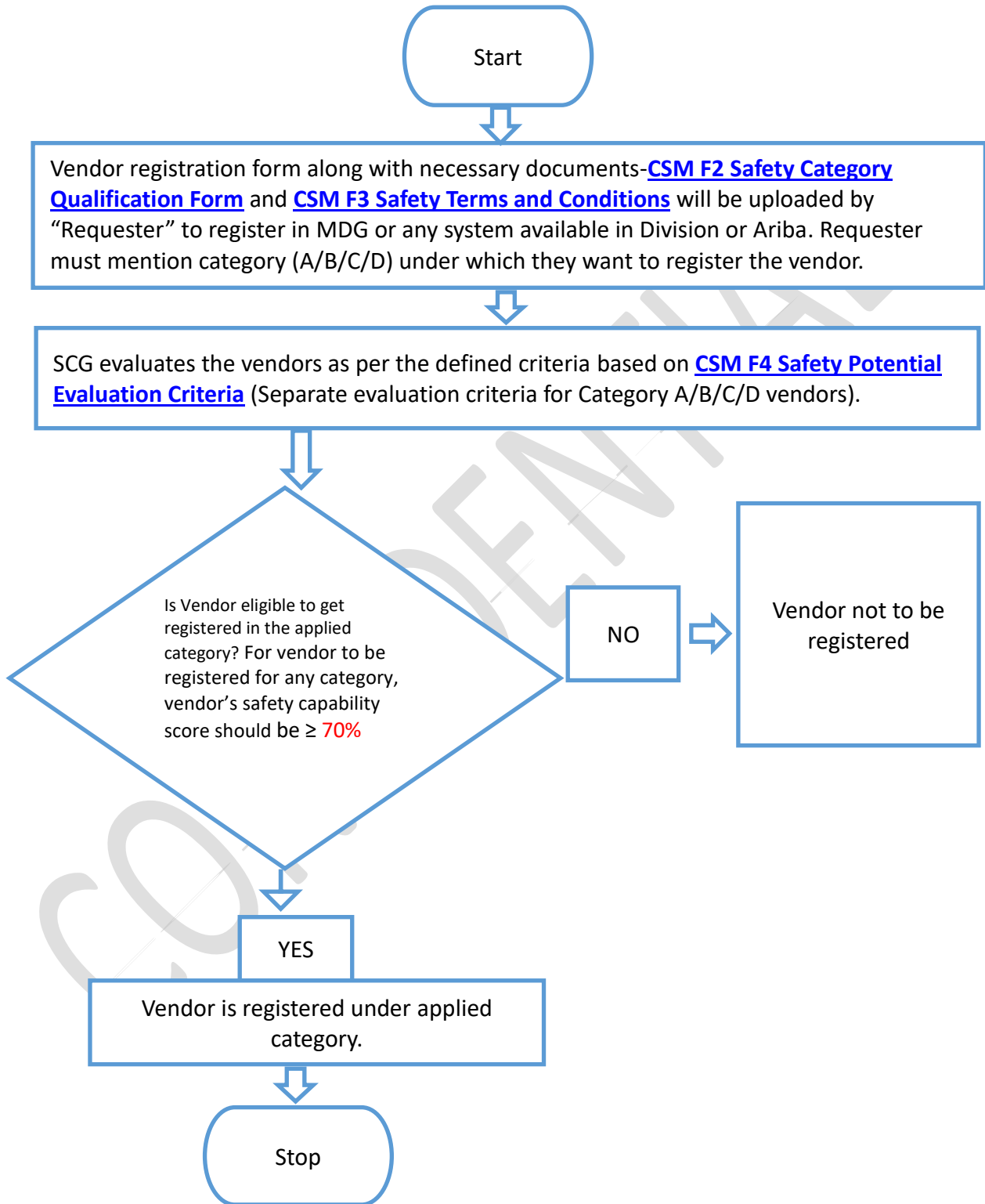

The Tata Power Company Ltd	 	Contractor's Safety Code of Conduct
Document no TPSMS/GSP/ CSM/015/REV 07		Date of Issue: 01/08/2023

Appendix 2: CSM F2 - Safety Category Qualification form

1. "Safety Category Qualification Form" is part of vendor registration form. It needs to be filled by the contractor at the time of Registration and should be submitted to Requester / Order Manager with all relevant documents.
2. The same will be evaluated by Safety Concurrence Group of the Division (SCG).
3. Information provided by contractor will be verified during site visit.

Safety Category Qualification Form

Please consider my application for

Category A Vendor: Vendor eligible to carry out Very High- and High-risk O&M/Project jobs

Category B Vendor: Vendors eligible to carry out technical jobs, classified as Medium / low risk

Category C Vendor: Vendors eligible for to carry out low or very low risk administrative and office job

Category D vendor: All Consultants, Medical Practitioners or vendors taking job from Tata Power and working from their own premises.

Name of the Vendor:							
Sr. No	Safety Information	Yes / No	Remarks				
1	Certified for i. ISO 45001, ii. ISO: 14001 iii. ISO: 9001 (ISO certificates to be issued from reputed accreditation agencies specified by Tata Power)	i. Y/ N ii. Y/ N iii. Y/ N	If Yes, Attach copy of the certification. If No, mention plan to get the certification.				
2	Safety Statistics for current and Last Three (3) Years - LTIFR - LTISR	Yes/No		Current Year	Year 1(Last FY)	Year 2	Year 3
			LTIFR				
			LTISR				

Name of the Vendor:

3	Any Compensation paid due to accidents during current and last three years?	Yes/No	Amount (INR)	Manhour
			Current Year	
			Y1 (Last FY)	
			Y2	
			Y3	
4	Any prosecution against you by statutory bodies/clients during last three years due to statutory violations, criminal negligence towards safety and dereliction of duty of care towards your employees? Is any case still pending against you?	Yes/No	If yes, give details. If no, give an undertaking that no case is pending against you and you have not been prosecuted by statutory bodies or clients.	
5	Do you have Safety Policy? Safety Principles? And Lifesaving Rules?	Yes/No	If yes, attach copy of the documents available.	
6	Do you have Safety training process?	Yes/No	If yes, attach safety training process and average training manhour of your employees for the last three years.	
7	Do you have a system for recording, reporting, and investigating all incidents or near misses?	Yes / No	If yes, show the incident statistics of last three years and implementation of CAPA.	
8	Do you have a disciplinary action program against your employees for violation towards safety rules and procedures?	Yes/No	If yes, show the records of disciplinary action taken the last three years.	

The Tata Power Company Ltd	     	<i>Contractor's Safety Code of Conduct</i>
<i>Document no TPSMS/GSP/ CSM/015/REV 07</i>		<i>Date of Issue: 01/08/2023</i>

Name of the Vendor:			
9	Do you have a reward and recognition scheme for your employees who show exemplary safe behavior and contribute to overall safety improvement at site?	Yes/No	If yes, show the records of Reward and Recognition given during the last three years.
10	Do you engage in safety promotional activities?	Yes/No	If Yes, Show the proof of engagement in safety promotional activities.
11	Have you been recognized or awarded or rewarded by government bodies of clients for showing excellence in safety management in your jobs during last three years?	Yes / No	If Yes, Show proof.
12	Do you provide adequate quality of PPEs to your workmen?	Yes/No	If yes, please provide details of PPE Matrix and if required, samples for inspection.
13	Do you have Safety organization structure e.g., Safety Officers and Safety Committees?	Yes/No	If yes, attach copy of the safety organization structure, details of safety committees and safety professionals.
14	Name and address of sites where work is in progress or worked earlier	Yes/No	Site details to be attached for inspection by Tata Power-Division /DISCOM Officials.

Note: If you respond NO to any of the above questions, you can mention your plan to get the required documents.

I hereby confirm that the information provided above are true. I give my consent to be penalized as deemed fit in case any information given above are found to be false.

I will abide the general safety guidelines mentioned in the purchase order / work order and will ensure to prepare and follow site specific safe operating practices in consultation with the site-in-charge and safety professional. I will abide by penalty scheme in case of non-compliance.

Signature :

Name and Designation:

Stamp of Organization :

The Tata Power Company Ltd	     	Contractor's Safety Code of Conduct
Document no TPSMS/GSP/ CSM/015/REV 07		Date of Issue: 01/08/2023

Appendix 3: CSM F3 - Safety Terms and Conditions

(Attached as a separate document under the title CSM F3 – Safety Terms and Conditions)

Appendix 4: CSM F4 - Safety Potential Evaluation Criteria for Vendor Registration

At the time of vendor registration, vendor will be registered under 4 categories

- 1) **Category A**- Vendors eligible to carry out High risk Jobs
- 2) **Category B**- Vendors eligible to carry out technical jobs that are Medium/low risk
- 3) **Category C**- Vendors eligible to carry out administrative and office jobs
- 4) **Category D**- Outsourced Jobs / Consultants /Medical Practitioners / Suppliers etc

For vendors to be registered under **Category A/B**, a safety potential evaluation will be carried out based on following parameters. (Actual score is safety capability score)

Sr No	Description	Weight age (%)	Actual Score
1	Does the service provider have a valid 45001 Certification?	10	
2	During site visit check for safety adequacy at site	20	
3	Check the Safety statistics of Service provider (If available than 10 otherwise Zero)	10	
4	Check the trend LTIFR/LTISR for last 3 years (If less than 0.2 than give 10 Marks if between 0.2 to 0.3 than give 5 marks and otherwise Zero	10	
5	Has there been any prosecution / conviction for any Contravention regarding safety and Health provision under the factories Act/Electricity Act / BOCW Act and Rules framed there under? If yes Give Zero otherwise 10 Marks.	10	
6	Check the Safety orientation & training process of Service provider- Records of Safety training provided to safety officer/supervisor /workmen during last 1 year as percentage (%) of total employed by service provider ✓ Safety Officer: >80% of employees: 5 Marks, 50 to 79% of employee: 2.5 Marks and <50%: Zero. ✓ Safety supervisor: >80% of employees: 5 Marks, 50 to 79% of employee: 2.5 Marks and <50%: Zero. ✓ Workmen: >80% of employees: 10 Marks, 50 to 79% of employee: 5 Marks and <50%: Zero	20	
7	Check the organizational structure for safety professionals & engineers / supervisors. ✓ Check Availability of number of Safety Officers from government recognized institute as per workforce strength. 1 in 50 employees than 10 Marks, if 1 in 100 than 5 Marks otherwise Zero.	15	

The Tata Power Company Ltd	    	Contractor's Safety Code of Conduct
Document no TPSMS/GSP/ CSM/015/REV 07	TATA POWER	Date of Issue: 01/08/2023

	✓ Check Availability of Qualified workforce from government recognised institute/TPSDI. 100% of safety officers qualified than 5 Marks, 50% TO 99% Than 2.5 Marks and if less than 50% than Zero Marks.		
8	Certified/skilled workers as a percentage of overall workforce	5	
	Total	100	

Evaluation Criteria for Category C

Sr no	Description	Weight age (%)	Actual Score
1	Does the contractor have a valid ISO 9001 certification?	40	
2	Check the Safety statistics of Service provider (If available than 10 otherwise Zero)	10	
3	Check the trend LTIFR/LTISR for last 3 years (If less than 0.2 than give 20 Marks if between 0.2 to 0.3 than give 10 marks and otherwise Zero)	20	
4	Has there been any prosecution / conviction for any Contravention regarding safety and Health provision under the factories Act/Electricity Act / BOCW Act and Rules framed there under? If yes Give Zero otherwise 10 Marks.	10	
5	Check the Safety orientation & training process of Service provider- Records of Safety training provided to safety officer/supervisor /workmen during last 1 year as percentage (%) of total employed by service provider ✓ Safety Officer: >80% of employees: 5 Marks, 50 to 79% of employee: 2.5 Marks and <50%: Zero. ✓ Safety supervisor: >80% of employees: 5 Marks, 50 to 79% of employee: 2.5 Marks and <50%: Zero. Workmen: >80% of employees: 10 Marks, 50 to 79% of employee: 5 Marks and <50%: Zero	20	
	Total	100	

Evaluation Criteria for Category D

Category D does not require any evaluation as it is for outsourced job outside the Tata Power company premise.

For vendor to be registered for any category, vendor's safety capability score should be $\geq 70\%$.

Appendix 5: CSM F5 - Flow Chart for Issuing RFQ and PO

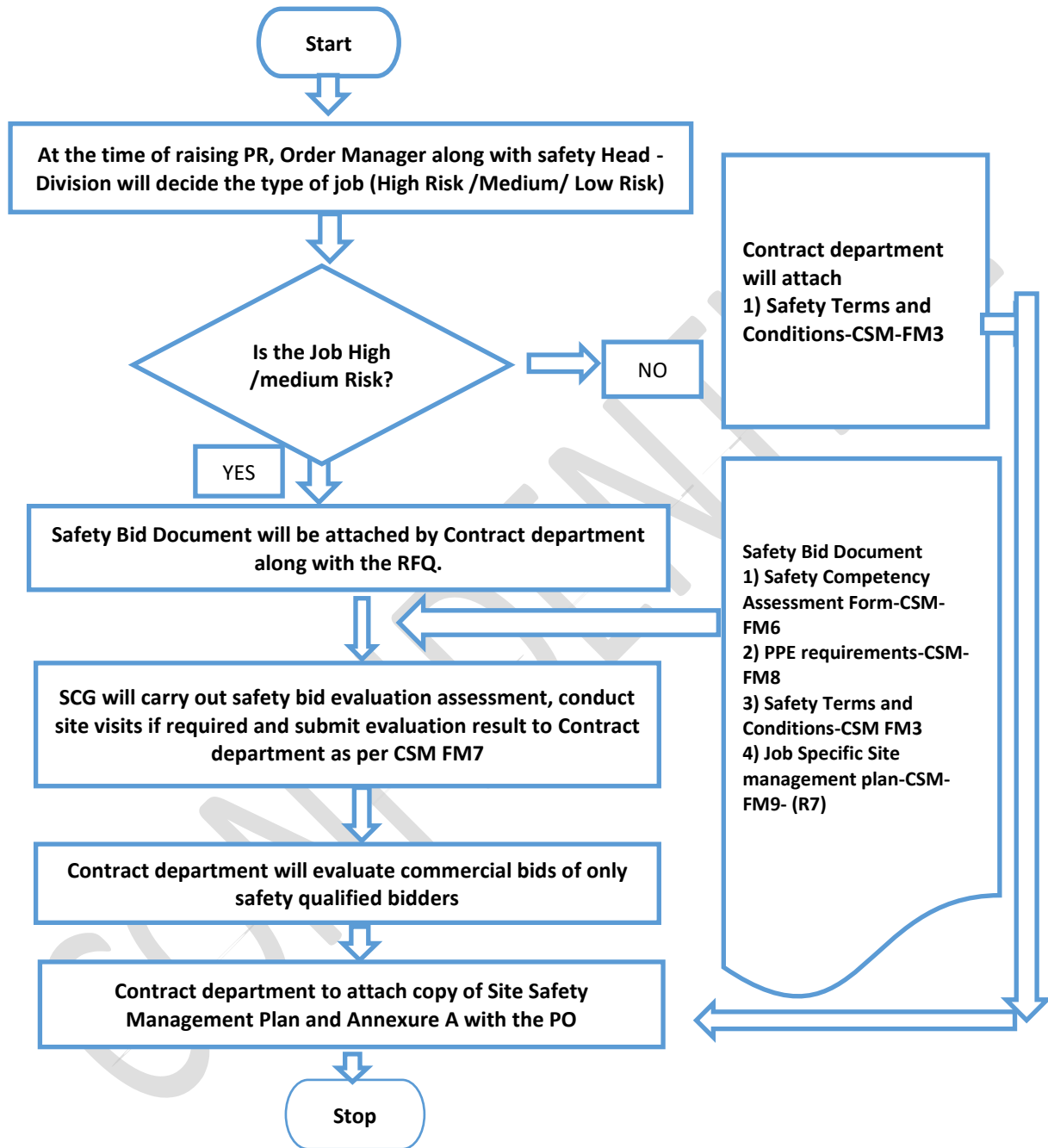

Appendix 6: CSM F6 - Safety Competency Assessment Form (Template)

Name of the Vendor/Bidder:
 Name of the Sub Vendor (If job is given to Sub Vendor):
 Description of the Job:
 Request for Quotation (RFQ) No.:

Vendor/Bidder to mandatorily provide the below safety competency related information:

1. Proposed Manpower Deployment Schedule :-

Type of manpower	Qualification	Experience	Month 1	Month 2	Month 3
<u>Project /AMC Manager(R7)</u>						
Site In Charge						
Safety Manager						
Safety Officer						
Supervisors						
Technicians						
High Skilled workmen						
Skilled workmen						
Semiskilled workmen						
Lineman						
Helpers						
Drivers						
Unskilled						
<u>Others(R7)</u>						

Instruction to Bidders:

- i. Indicate the overall site manpower deployment schedule as above
- ii. Indicate direct or subcontracted employees by using color code given below:

Direct Bidder Employee – Green

Partly Direct / partly Subcontracted – Yellow

4.3.5 **Subcontracted – Red** *If subcontractor detail is not available at stage of Bid evaluation, then this can be agreed with Order manager or Engineer in charge before deployment Ensure that all sub-contractors follow the Tata Power Safety Procedure and agreed CSM F9 Site Safety Management Plan.R7*

- iii. Against each category, indicate minimum educational qualification and work experience

The Tata Power Company Ltd		Contractor's Safety Code of Conduct
Document no TPSMS/GSP/ CSM/015/REV 07		Date of Issue: 01/08/2023

- iv. Add rows to include other specialized manpower, if any.
- v. Extend columns to cover the entire duration of the proposed contract.
- vi. If the operation is in shifts, then indicate shift in charge and / or safety officers required for each shift operation.

2. List of Tools, Tackles, Machines and Equipment: -

Bidder/ Vendor to provide the list of tools, tackles, equipment **to be used during the job / project execution**. Bidder/Vendor to ensure that all the lifting tools and tackles, pressure vessels are duly certified by the competent person authorised by the Chief Inspector of Factories of the respective state prior to start of the job

Sr. No	Description of Tools / Tackles	Capacity / Rating	Quantity	Make	Year of manufacture	Remarks
1						
2						
3						
4						
5						
.....						

3. Safety Records:

Bidder to provide the details of fatalities and lost workday cases (LWDC), occurred in last three years (data to be provided for the last completed FY and preceding 2 years).

Description	Safety Data for current and Last 3 Years			
	Current Year	Year 1 (Last FY)	Year 2	Year 3
		20__ - __	20__ - __	20__ - __
Fatalities (Nos.)				
Lost Workday Cases (Nos.)				

In case of no fatalities, LWDC during any year, the form may be filled stating NIL against the respective year. Bidders are encouraged to also submit the RCA / incident investigation reports and the learning's implemented out of the above reported incidents

4. Job Safety Plan/ Method Statement:

Bidder to provide / enclose a detailed Site/Job Safety Plan along with a Method statement detailing the execution philosophy (how the bidder intends to execute the Job/Project), identifying all key activities which are required to be performed by the contractor at Site.

The Tata Power Company Ltd	     	Contractor's Safety Code of Conduct
Document no TPSMS/GSP/ CSM/015/REV 07		Date of Issue: 01/08/2023

Bidder to also list down all high-risk activities and provide the Hazard Identification and Risk Assessment (HIRA) for all such high-risk activities involved in the site work.

(Use Method Statement template attached as Appendix 9)

5. PPE Requirement -R7

Division/DISCOM Requirement	Bidders Response
The Bidder/Vendor shall ensure that all PPE of Approved standards as per CSM F8 – PPE Requirements shall be always available and shall be used by his employees with no exception whatsoever. Bidders to also ensure Standard PPE matrix of Tata Power to be followed for all activities.	
10% Buffer stock of PPEs to be provided by bidders at each circle to meet any contingency	
Bidder will ensure that sample PPEs to be submitted/approved by Safety Department along with EIC at the time of submission of Safety bids for evaluation In case bidder manpower found using substandard or any PPEs which are not approved by the Tata Power-Division /DISCOM representative, then Tata Power-Division /DISCOM will provide the same to manpower deployed at the cost of bidders.	

6. Vehicle Deployment: Bidders to provide details of all vehicles deployed during execution of work-(R7)

S. No.	Vehicle No.	Vehicle Type	Location	EV/CNG/Diesel/Petrol	Year	Whether CNG endorsed on RC

The Tata Power Company Ltd	    	Contractor's Safety Code of Conduct
Document no TPSMS/GSP/ CSM/015/REV 07	TATA POWER	Date of Issue: 01/08/2023

7. Crane Deployment-(R7): Bidders to provide details of crane to be deployed during the execution of work as and when required. Bidders to provide approved new gen crane ACE Model SX150, ACE FX150 and Escorts Model TRX 1550.

SI No	Crane No	Location	Year

8. Training Records-(R7): Bidders to provide training records of employees deployed for the execution of work during last one year. These training includes OHS (Occupational Health and Safety) Training, Training on SOP/Work Procedures and Medical Emergency trainings imparted at their own facility, cost, and expenses. Bidders to provide the following details:

Tata Power-Division /DISCOM Requirement	Bidders Response
Training records of employees at their own facility, cost, and expenses for last one year	
Training facility available with Bidders	
Future road map for enhancing the competency of workforce	

9. Rewards and Recognition-(R7): Bidders to provide the details of process deployed in their organization for sharing and resolution of safety concerns raised by their employees. Also, bidders to provide the details of Rewards and Recognition process in their organization for safety to encourage the morale of their workforce.

10. Management System Certification: -

Sr.No	Certification	Yes / No	If Yes, Year of Certification	If No, Target date for Certification
1	ISO 9001			
2	ISO 14001			
3	ISO 45001			
4	Any other (Specify....)			

Note: Please attach certificates to support above. In case not accredited for above but applied for, application letters may be attached.

The Tata Power Company Ltd	     	Contractor's Safety Code of Conduct
Document no TPSMS/GSP/ CSM/015/REV 07		Date of Issue: 01/08/2023

Appendix 7: CSM F7 - Safety Bid Evaluation Criteria

The User must select whether the job is high /Medium Risk and long duration at time of raising the PR.

- 1) The decision whether job is "is high /Medium Risk "or not has to be made by order manager based on Risk involved (Risk Priority Number in HIRA) of the Jobs. An indicative list of high-risk jobs is attached as Appendix 14. The risk assessment will be done along with Division safety Head. R7
- 2) If a technical job is of low risk with estimated duration of the contract more than one year, the job should be treated as "long duration". R7
- 3) All Safety bids will be evaluated by Safety Concurrence Group. Structure of SCG will be declared by contract department with the assistance of Division / Discom safety. Safety team will audit bid evaluation process of a few selected jobs and Quality of evaluated safety Bids.
- 4) Records of jobs sent by for Safety Bid evaluation shall be maintained by Contract team in existing tracing sheet along with other jobs.
- 5) Safety bid evolution will be done by SCG within one working week. R7
- 6) Contracts / Division shall provide a list of regular Contractors participating in multiple tenders during the year for a one-time umbrella Safety Evaluation of Bidder (as against the specific Bid evaluation) by indicating the nature of the type of jobs / works which the BA usually participates in bidding. SCG shall evaluate such bidders for the requested works and on satisfying the evaluation criteria may be granted a Safety Pre-Approved status for the specific types of work (e.g., O&M of Boiler, Turbine, CHP, AHP, Turnkey EPC, Switchyard, Distribution Electrical Contract etc.) which shall be initially valid for a period of 1-year and shall thereon be extended further against revalidation / re-evaluation as required. R7
- 7) Business Associates having such Safety Pre-Approved status for the type / category of jobs shall be exempted from submission of Safety Evaluation Bid against each tender provided that their Safety Pre-Approved status is valid for the subject work / tender. R7
- 8) A suitable system shall be developed by Contracts to track the validity of such Safety Pre-Approved status of Bidder for timely renewal failing which the Safety Pre-Approved status shall cease and Bidder will thereon have to provide Safety Bids with each tender until such one-time approval is renewed. R7

The Tata Power Company Ltd	  	Contractor's Safety Code of Conduct
Document no TPSMS/GSP/ CSM/015/REV 07	  	Date of Issue: 01/08/2023

Safety Bid Evaluation will be based on following parameters.

Evaluation Criteria-(R7)

S. No.	Description	Max Marks	Criteria for evaluation
1.	Qualification and Experience of manpower	15	As per Clause No. 1
2.	Tools and Tackles to be provided by bidder	15	To be evaluated as per approved tool list of concerned departments.
3	PPE Requirements	5	To be evaluated as per approved PPEs standard and PPE Matrix specified in CSM
4	Job Safety Plan/ Method	15	To be evaluated as per as per SOP/WI/HIRA
5	Vehicle Deployment	5	Weightage will be given for CNG Vehicles with endorsement of CNG kit on RC/Electrical Vehicle
6	Crane and Mechanized heavy equipment Deployment	15	Date of manufacturing or running hours
7	Training Records	5	Training records to be evaluated with evidence and scoring to be done as per availability of records
8	Certificate Accreditation	5	ISO 9001-2.5 Marks ISO 45001- 2.5 Marks ISO14001- 2.5 Marks. Total Max 5 Marks for all Three
9	Safety Initiative for learnings implemented in accidents in organization and work force (Fatal / Non-Fatal)	15	Maximum 15 marks will be awarded for visible evidence in terms of safety initiative deployed based on learning of accident in organization and workforce in case of accident
10	Rewards and Recognition Process	5	Maximum 5 marks will be awarded for R&R process evidence
Total		100	

Safety Records (Lag Parameter)-(R7)

1.	Fatal Accident	(-) 10 Marks for each case with max of 15 marks	<p>For any fatality in Tata power /Other company in Current and last three years 10 marks will be deducted with maximum up to 15 marks.</p> <p>For new entrant BA, these marks will be deducted for Past safety records.</p> <p>If and BA found hiding such facts, then contract will be terminated immediately during the execution stage.</p>
----	----------------	---	---

The Tata Power Company Ltd	     	Contractor's Safety Code of Conduct
Document no TPSMS/GSP/ CSM/015/REV 07		Date of Issue: 01/08/2023

2	LWDC (Non-fatal)	(-) 5 Marks for each case with max of 10 marks	<p>For each LWDC (Non-Fatal) case in Tata power /Other company in Current and last years, 5 marks will be deducted with maximum up to 10 marks.</p> <p>For new entrant BA, these marks will be deducted for past safety records.</p> <p>If and BA found hiding such facts, then contract will be terminated immediately during the execution stage.</p>
---	------------------	--	---

Final Qualifying Criteria

S. No.	Description	Max Marks	Criteria for evaluation
1.	Qualified Bidders	More than 70 marks	Marks Obtained. 60 Marks for New business-like Odisha Discom for one year from CSCC implementation date.

		Minimum Requirement	Weight age (%)	Score Obtained
Manpower	Safety Officer (1 per 500 workers) or as per requirement	<p>Qualification - Safety Officer shall possess recognized degree in any branch of engineering with practical experience in similar industries of Min 2 years and Advance Diploma In Industrial Safety by State technical board. (Each state government prescribes the qualification of safety officer.). Require knowledge of Local language.</p> <p>Experience- Minimum 2-year experience in relevant field as mentioned in the job in PR.</p>	5	
	Safety Supervisor (1 per work site up to max. 50 workers)	<p>Qualification- Supervisor shall possess ITI/ Diploma in relevant field. PDIS is desirable, but not mandatory. Require knowledge of Local language.</p> <p>Experience- Minimum 5-year experience in relevant field as mentioned in the job in PR.</p>	5	

The Tata Power Company Ltd	     	Contractor's Safety Code of Conduct
Document no TPSMS/GSP/CSM/015/REV 07		Date of Issue: 01/08/2023

		<p>Training – Trained and certified by Tata power Skill development Institute or equivalent institute in relevant safety procedures.</p> <p>Note: On request of the contractor/Users - TPDSI should vet & certify the skilled & experienced Technician if Technical Qualification is not adequate.</p>		
	<p>Qualified Technician (Skilled workers as electrician, rigger, fitter, welder, cable jointer, line men etc.)</p>	<p>Experience- Minimum 2-year experience (or experience prescribed by state government) in relevant field as mentioned in the job in PR.</p> <p>Training – Trained and certified by TPDSI or equivalent institute in relevant safety procedures.</p>	5	
<p>Tools & Tackles</p>	<p>Equipment / Machines/ Tools & Tackles (lifting and shifting tools)</p>	<p>The list of Equipment /Machines / Tools and tackles to be used for job to be submitted by the contractor.</p> <p>Evaluation of the list will be carried out based on</p> <ol style="list-style-type: none"> 1) Suitability as per the relevant job 2) Make and age of the tools from authorized agencies defined by the user. 3) Certification by the competent authority of respective state. 	15	

The Tata Power Company Ltd	     	<i>Contractor's Safety Code of Conduct</i>
<i>Document no TPSMS/GSP/CSM/015/REV 07</i>		<i>Date of Issue: 01/08/2023</i>

Appendix 8: CSM F8 - PPE requirements-(R7)

The Contractor shall ensure that the following PPE of Approved standards shall be always available and shall be used by his employees with no exception whatsoever. • PPE shall be conforming to BIS/DGMS/DIN specifications, in good condition and shall be comfortable to his employees, when used. This is indicative. For better clarification refer PPE procedure-TPSMS/GSP/PPE/023. as per safety terms and condition Appendix 3 CFM 3 in detail. R7

PPE Requirement

1	All contractor's employees at site	Safety Florescent Jacket (orange color), Safety helmet & safety shoes with composite or steel toe cap
2	Workers mixing asphalt, cement, lime / concrete	Safety goggle & protective Hand gloves and footwear, Nose mask.
3	Welders / Grinders/Gas cutters	Welding screen/goggles, safety shoes, leather hand gloves, aprons, leg guard
4	Stone breaker	Protective goggle, hearing protection, anti-vibration hand gloves and Protective clothing.
5	Electricians / Linemen	Rubber hand gloves <i>with correct voltage rating and expiry date normally one year from Manufacturing date-(R7)</i> & Electrical resistant shoes, Safety helmet with induction strip to alert about presence of voltage for those linemen who climb the poles or work on electrical equipment
6	Workers working at a height of 1.8 Meter or above.	Double lanyard full body harness, fall arrestor and safety net made of reinforced nylon fiber ropes firmly supported with steel structures, Work positioning attachment

PPE Type and Testing Frequency





Sl. No.	Name of PPE	IS / EN Standard	Testing Frequency	Remarks
01	Leather Safety Shoes (Color – Black) with PU toe cap.	IS:15298 (Part-2)	Monthly and visual check every day for any crack or damage in the leather or sole.	

The Tata Power Company Ltd	  	<i>Contractor's Safety Code of Conduct</i>
<i>Document no TPSMS/GSP/CSM/015/REV 07</i>	  	<i>Date of Issue: 01/08/2023</i>

02	HDPE Safety helmet with chin strap and ratchet type for adjustment for non-Electrical work	IS:2925-1984	Monthly and visual check every day for any crack in shell.	
03	Full body harness (Safety belt)	EN 361	Monthly and visual check every day of the bends and the harness.	
04	Electrical Safety Gloves	EN: 60903 CE marked	Weekly and visual check for any crack and blow test before every work.	Manufactured not beyond 12 months.
05	Full face visor with safety helmet	EN: 166 CE marked (Visor)	Monthly and visual check every day for any crack in shell.	Clear acrylic visor attached with safety helmet.
06	Fireproof jacket for chest protection		Monthly and visual check every day.	
07	Safety helmet with induction Strip for linemen and working for electrical work-Class E	EN 397/2012	Monthly and visual check everyday	Induction Strip alerts presence of voltage
08	Shorting clamps, crocodile clamps, Discharge Rod and Neon tester		Monthly and visual check everyday	For discharging the residual voltage and test before touch

Pictorial View of PPEs for reference purpose

Sl. No.	Name of PPE	IS / EN Standard	Picture
01	Leather Safety Shoes (Color – Black) with PU toe cap.	IS:15298(Part-2) and with test report of electrical resistance.	

02	<p>HDPE Safety helmet with chin strap and ratchet type for adjustment for Nonelectrical work and electrical work</p>	<p>IS:2925-1984/ EN 397/2012</p>	
03	<p>Full body harness (Safety belt) The straps at shoulder and thigh shall have full pad for comfort. The back shall be so designed that harness straps do not tangle with each other.</p>	<p>EN 361:2002 EN 358 : 2000 IS: 3521:1991/2002</p>	
04	<p>Electrical Safety Gloves – Composite type Soft electrical gloves as per size of individual.</p>	<p>EN: 60903 CE marked</p>	
05	<p>Full face visor with safety helmet</p>	<p>EN: 166 CE marked (Visor)</p>	
06	<p>Fireproof jacket for chest protection</p>		
08	<p>Reflective jacket to each workman</p>	<p>As per Tata Power standard</p>	

The Tata Power Company Ltd		Contractor's Safety Code of Conduct
Document no TPSMS/GSP/ CSM/015/REV 07		Date of Issue: 01/08/2023

These pictures are indicative. Actual product may vary.

Note:

1. Any other Personal Protection Equipment required beyond above list will be according to BIS or EN Standards.
2. All Personal Protection Equipment will be checked by the engineer in-charge or SAFETY group of company.
3. Safety Representative of the BA must maintain the record of the availability, condition and checking of the PPEs.
4. All tools required as per the contract must be according to respective IS / EN standards.
5. Company may revise or add the above list of PPE and their specifications as and when feel necessary. The information about new specifications /models will be circulated by the Engineer In-charge (EIC), which shall adhere by the business associated in the shortest possible time. The EIC shall issue a memo / instruction to BA with timeline for implementation. Any delay will be treated as non- compliance / safety violations.

Appendix 9: CSM F9 - Site Safety Management Plan / Method Statement

Site Safety Plan / Method Statement (Template)

This Method Statement describes the specific safe working methods which will be used to carry out the described work. It gives details of work procedure with control measures to counter health and safety issues related to this work. The listed content of this Method Statement can be changed/modified subjected to job scope / specifications, but task specific method statement once finalized & approved, that should not be modified during work execution without permission from the approving authority.

Project/Job Name		
Scope of work: -		
Drawing References: -		
Detail of Sub contractors involved: -		
Method Statement Prepared By: - Designation: - (e.g., Site Manager)	<u>Signature</u>	<u>Date</u>

The Tata Power Company Ltd	     	<i>Contractor's Safety Code of Conduct</i>
<i>Document no TPSMS/GSP/CSM/015/REV 07</i>		<i>Date of Issue: 01/08/2023</i>

1.0 Introduction (*Describe purpose of the work, give details of type and scope of work being carried out*)

2.0 Location of Work (*Give site address and precise location on site where work is to be carried out*)

3.0 Safety Document /Specific Approval Required (*Details of any safety documents or specific approval i.e., Client specific approval required to undertake the work*)

5.0 Role & Responsibilities of Personnel/Parties Involved in activities: *Clearly define roles and responsibilities of all personnel involved in activity i.e., Site management staff including subcontractors' staff, Project Manager/Site Manager of principal contractor, Sub Contractor Site Manager, Project Engineer, Safety officer, Competent Supervisory Staff etc.)*

The Tata Power Company Ltd	     	Contractor's Safety Code of Conduct
Document no TPSMS/GSP/ CSM/015/REV 07		Date of Issue: 01/08/2023

6.0 Working/Activity Description: - *It is important that all operatives should have clear idea of those operational sequences and responsible supervisor must verify their competency prior to their engagement in operation.*

6.1 Pre-Working Checks

6.2 Resources (Equipment, tools including manpower) Details *i.e., Equipment and Tools, specific operational equipment, test kits, lifting resources, Details of materials to be used in operation, including any reference to COSHH assessments in case of use of any chemicals, Details of the manpower allocated to the task, e.g., titles, qualifications, competences, direct manpower, contractors. Details of plant, tools, and equipment to be used for the work, including the availability of relevant statutory documents, checks or inspections etc. Details of fencing, barriers, cones, chains, dangers notices, warning signs etc.*

Tools required for work:

Sr.No	Tools /Equipment /Machine	UOM	Required Qty.	Remark
1				
2				
3				
4				
5				
6				
7				
8				
9				
10				

6.4 Operational Sequence of work: - *Full description of the work, setting out the methodology in a sequential manner, including any reference to any identified operational restraints. Also refer here sec. 5.0 responsibilities part for every step of work sequence).*

S. No	Activity	Details of job sequence	Risk Involved	Control Checks
1.				
2.				
3				
4				
5.				

6.7 Final Checks & restoration of work area after completion of work: *Those checks to be carried out by responsible supervisor in witness of his line hierarchy by use of specific checklist of certain operational checks and once those completed satisfactory, PTW (if applicable) to be closed and isolation arrangements to be restored by removing barricades/cautionary tags.*







7.0 Task Specific Hazards: - *Refer to Task Specific Risk Assessment and attach in appendix*

Attachment: - Specific Risk Assessment

In addition, please provide below control measures in risk assessment *(as applicable)*.

Fall Protection Measures: (Where Work at height cannot be avoided)	
Control Measures for Electrical Hazards	
Others Hazard if any (please provide details)	

The Tata Power Company Ltd	     TATA POWER	Contractor's Safety Code of Conduct
Document no TPSMS/GSP/ CSM/015/REV 07		Date of Issue: 01/08/2023

Hazardous Substances to be used in job: (Attach MSDS if required)	 Acute Toxic	 Health Hazard	 Corrosive	 Dangerous For the environment	 Oxidising	 Highly flammable	 Explosives
	Y/N	Y/N	Y/N	Y/N	Y/N	Y/N	Y/N

7.0 Emergency Provisions: *Relevant operational possibility of a programme in the case of emergency situation i.e. electrical supply restoration. In addition, emergency response provisions i.e., first aiders, firefighting, and first aid arrangements, nearest onsite/offsite emergency response also to be considered during emergency planning.*

8.0 "5S issues" / Waste Disposal/ Housekeeping and Environmental issues: *Details waste disposal processes and or housekeeping activities, Details of environmental impacts and control measures.*

9.0 Personal Protective Equipment (PPE): *Tick on PPE requirements for the task/Job*

Safety Helmet / Hard Hats		Safety Shoe / Safety Boots	
Gum Boot		Double Lanyard Safety Harness with work positioning attachment	
Electrical Hand gloves		Other hand gloves	
Eye protection		Respiratory protection	
Ear Protection		Electrical Arc flash suit	
Chemical resistant suit		Reflective Jackets	
Any Other		Any Other	

10.0 First Aid facilities and Nearby Hospitals Details

- Name of On Site First Aider
- First Aid Box Location
- Location of nearest hospital

11.0 Occupational Health, Fitness and COVID-19 related Preparedness:

- Please give a brief writeup / methodology of your organization's plan to avoid impact of the COVID-19 pandemic at Tata Power working site.
 - Please give brief details of occupational health and hygiene related interventions planned by your organisation to ensure good health and fitness of workforce at Tata Power site.

Appendix 10 – CSM F10 – Process Flow Chart for Safety Performance Evaluation

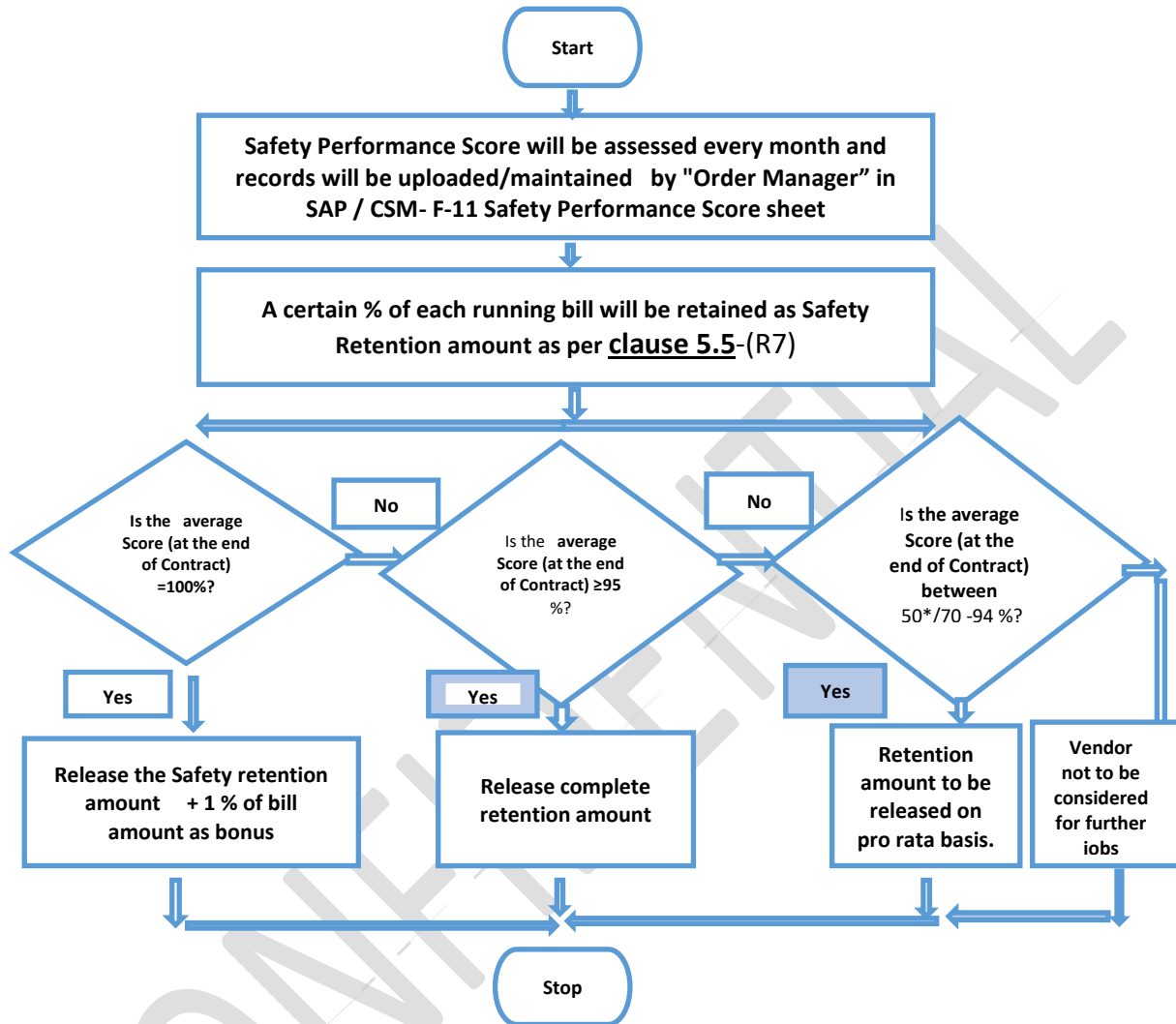

* For New Business such as Odisha Discoms-(R7)

The Tata Power Company Ltd	     	<i>Contractor's Safety Code of Conduct</i>
<i>Document no TPSMS/GSP/ CSM/015/REV 07</i>		<i>Date of Issue: 01/08/2023</i>

Appendix 11: CSM F11 - Safety Performance Evaluation Criteria
Safety Performance Evaluation Report- CSM F11

Sr. No	Parameter	Unit of Measurement	Target	Weight age	Actual Performance	Actual Score
Lead Indicator						
1	% of Employee certified in TPSDI/Authorized agency	%	100%	20		
2	Monthly inspection and replacement of damaged Personal Protective equipment -PPE by_contractor	%	100	10		
2	Monthly inspection and replacement of damaged Critical Equipment, lifting Tools & Tackles and hand tools used at site by_contractor	%	100%	15		
3	Condition of critical tools, tackles, and equipment to be checked by order manager or Engineer in Charge.	%	100%	10		
4	Safe Disposal of Waste generated (Designated way) Records of Waste generation (Hazardous waste, oily cotton waste, E Waste) No effluent to drain or discharge to ground	Yes / No	Yes	10		
Lag Indicator						
1	Number of Fatalities	No	0	15 / 20*		
2	Number of Lost workday case (LWDC) (reportable)	No	0	10 / 15*		
3	No of Recordable Cases (Exclude Fatalities and LWDC)	No	0	5 / 0*		
4	Man-days Lost	Man-days	0	5 / 0*		
					Final Score	
					Invoice Value	
					Amount to be released	

The Tata Power Company Ltd	     	Contractor's Safety Code of Conduct
Document no TPSMS/GSP/ CSM/015/REV 07		Date of Issue: 01/08/2023

Safety Performance Evaluation Criteria

Lead Indicators

		Target			
1	% of employees certified in TPSDI/Authorized agency	100%	51% to 99%	50%	<50%
	Score	20	Pro-rata	10	0
2	Monthly inspection and replacement of damaged Personal Protective equipment - PPE by contractor	100%	99% to 50%	<50%	
		10	5	0	
2	Monthly inspection and replacement of damaged Critical Equipment, lifting Tools & Tackles and hand tools used at site by contractor	100%	99% to 50%	<50%	
	Score	15	7	0	
3	Condition of critical tools, tackles and equipment <i>to be checked by order manager</i>	100%	<100%		
	Score	10	0		
4	Safe (designated way) Disposal of Waste generated, Records of waste (Hazardous Waste – Oily cotton waste – E- waste etc.) generation No effluents to drain/discharges to ground	YES	NO		
	Score	10	0		

Lag Indicators

		Target			
1	Number of Fatalities	0	>0		
	Score	Score	15 / 20*	0	
2	No of LWDC - Reportable	0	>0		
	Score	Score	10 / 15*	0	
3	No of Recordable Cases (Exclude Fatalities and LWDC)	0	1	>1	
	Score	Score	5 / 0*	5	0
4	Man-days Lost	0	1-5	>5	
	Score	Score	5 / 0*	5	0

* For New Business such as Odisha Discoms-(R7)

Appendix 12: CSM F12 - Safety Violation Penalty Criteria

Major Violations and Escalation matrix--(R7)

Consequence of safety violation observed not related to incidents or accidents		Violations				
Sl. No.	<u>Safety Violation</u>	1st	2nd	3rd	4th	<u>Subsequent violation</u>
1	Working without required PPE such as Helmet/gloves/safety shoes/Safety harness etc.	A	B	C	D	Will Attract the same penalty as 4th violation
2	Working without proper tools and tackles	A	B	C	D	
3	Poor or bad condition of Crane/Hydra/Vehicle and/or Incompetent driver and/or helper).	B	C	D	E	Termination of Contract and blacklisting after repetition of violations (3 to 4 times as the case may be)
4	Improper Working at Height	B	C	D	E	
5	Untrained /unauthorized workman engaged in high-risk jobs	B	C	D	E	
6	Violation of SOP or WI or LOTO	C	D	E		
7	Working without PTW or LC / Without authorization / Without creating Safe Zone	C	D	E		

Legend	Action to be Taken	Responsibility	Penalty (INR)	Repeat Violations
A	Levy of Penalty	Order manager / EIC	5000	The no. of repeat violations shall be calculated cumulative during the contract period, not on a monthly basis
B	Memo to BA and Levy of Penalty	Order manager / EIC	10000	
C	Memo to BA and Levy of Penalty	Order manager / EIC	25000	
D	Memo to BA and Levy of Penalty	Order Manager / EIC	50000	
E	Memo to BA, Levy of Penalty, Termination of Contract, Blacklist	Order Manager / EIC	100000	

The Tata Power Company Ltd	     	<i>Contractor's Safety Code of Conduct</i>
<i>Document no TPSMS/GSP/ CSM/015/REV 07</i>		<i>Date of Issue: 01/08/2023</i>

Other Violations and Penalty

Penalty shall be imposed on the contractors under the following circumstances for breaching the contractual agreements. The list is not exhaustive, but indicative.

Sl. No	Description of Violation	Severity	Penalty (INR)
1.	Unhygienic/Bad condition of PPE	2	500
2.	Unsafe Act/Condition of Severity 4	4	4000
3.	Unsafe Act/Condition of Severity 5	5	5000
4.	No Earthing of Electrical equipment	5	5000
5.	Working without efficient supervision	4	4000
6.	Non-reporting of incidents	3	3000
7.	Starting the job without Toolbox Talk	4	4000
8.	Electric cable tied with metal wire / Use of damaged electrical cable / Use of two core cable	3	3000
9.	Rubber mat not available in front of electrical panels.	3	3000
10.	Inserting naked wire into the socket instead of a plug	5	5000
11.	Inflammable materials stored inside PSS/FCC/Distribution Room	5	5000
12.	Water accumulation found near electrical panels / equipment	5	5000
13.	Grinding wheel/ Coupling/ Piling winch/other rotating parts without guard	4	4000
14.	Inadequate illumination of working area	3	3000
15.	Bringing inside PSS/FCC or any other work area any chemicals without approval.	5	5000
16.	Loose materials in work area which can fall down or fly during a storm	5	5000
17.	Misusing emergency facilities like fire hydrant line/ hose box/ spray system/ eye wash etc.	3	3000
18.	Entering restricted areas like switch yard, hazardous material storage room etc. without authorization	3	3000
19.	Not using 24 V lamp inside confined spaces	3	3000
20.	Bypassing/overriding safety interlocks	5	5000
21.	Working besides road without proper barricading and monitoring of traffic	5	5000

22	Smoking in prohibited area (Closed Go-downs, Storage of flammable material, Storage of Gas cylinders, PSS , Offices etc.)	3	3000
23	Improper stacking of materials in Storage Yard	4	4000
24	Sleeping at workplace	3	3000
25	First aid box not available / in locked condition	2	2000
26	Appointment of subcontractor without his Safety Bid Evaluation and/or without the permission of engineer in charge or Order manager.	5	5% of order value
27	Bad Housekeeping with respect to <i>TPSMS/GSP/GHK/022</i> <ul style="list-style-type: none"> • 1st Instant • 2nd instant • 3rd instant • 4th instant • Subsequent instants 	2	<ul style="list-style-type: none"> • 1000 • 2000 • 5000 • 10000 • 10000
28	Violations related to vehicles with respect to <i>TPSMS/CSP/RSP/015.</i> <ul style="list-style-type: none"> • Parking without wheel choke • Parking in undesignated area • Heavy vehicle without helper or co-driver • Seat belt not available / not used • Driver without license • Heavy vehicles without reverse horn • Using mobile phone while driving • Lights/mirrors not working /broken 	3	1000 per each violation
28	Violation in Gas cutting and Gas cylinder handling <ul style="list-style-type: none"> • Cylinder valve without guard • No flashback arrester • Leaky DA/Oxygen hose • Cylinders not kept in secured manner • Cylinder trolley not available • Cylinders are transported by manual rolling 	5	2000 per each violation
29	Violations in Lifting Operations w.r.t. to <i>TPSMS/CSP/HEMS/005</i> <ul style="list-style-type: none"> • Hook latch missing • Load raised or swung over people or occupied areas of building • Persons standing within the swing area of the crane • No barricading of crane working area • Use of damaged lifting tools and tackles 	5	2000 per each violation

The Tata Power Company Ltd	     	Contractor's Safety Code of Conduct
Document no TPSMS/GSP/ CSM/015/REV 07		Date of Issue: 01/08/2023

	<ul style="list-style-type: none"> Lifting tools and tackles not tested / Test certificate expired Crane operator without proper license Angular loading Lifting / shifting heavy material without guide rope Using mobile phone during loading and unloading jobs 		
30	<p>Violation in Scaffolding work w.r.t. to TPSMS/CSP/SCAF/007</p> <ul style="list-style-type: none"> Unstable scaffolding/nonstandard Scaffolding in use Handrails/mid rails/toe guards missing Safety harness not anchored on fixed structure Opening found in working platform 	5	2000 per violation
31	<p>Violation in Excavation Work w.r.t. to TPSMS/CSP/EXS/002</p> <ul style="list-style-type: none"> Loose material falling into excavated pit Water logging in excavated pits / trenches Inadequate or no barricading Undercut / cave in found on sides of excavated pits 	4	2000 per violation
32	Caution boards, danger signs (luminescent /red) along with emergency contact number are not found displayed.	3	3000
34	Spillage of hazardous material/chemicals during transportation	4	4000

Penalty for Incidents / Accidents-(R7)

Consequence of incident / Accident		Incident / Accident				Action Required
Sr.No.	Type of Injury	1st	2nd	3rd	4th	
1	Major Injury (Bone injury or burn or hospitalization >48 hrs.) Non-fatal	F	F	G	G	Intolerable
2	Major Injury (Bone injury or burn or hospitalization >48 hrs.) Non-Fatal (Two or more non-Fatal in one event)	G	G	H		
3	Single fatality	G	H			
4	Multiple fatalities (Two or more fatalities in one event). Anywhere in Tata power.	H				

The Tata Power Company Ltd	     	<i>Contractor's Safety Code of Conduct</i>
<i>Document no TPSMS/GSP/ CSM/015/REV 07</i>		<i>Date of Issue: 01/08/2023</i>

Legend	Action to be taken	Responsibility	Penalty (INR)	The no. of violations shall be calculated cumulative during the contract period for all contracts in SBU, not on a monthly basis
F	Memo to BA and Levy of Penalty	Order Manager/Engineer in charge	200000	
G	Memo to BA and Levy of Penalty	Order Manager/Engineer in charge	500000	
H	Memo to BA, Levy of Penalty, Termination of Contract and Blacklisting the BA	Order Manager/Engineer in charge	1000000	

Appendix -13: CHECKLIST TO BE USED DURING SITE VISIT

Checklist to be used: During site visit to check the adequacy Safety systems.			
		Observation	Score* (1-5)
1	Check the adequacy of safety policy and Safety Management system of the contractor.		
2	Does the contractor have written down safety procedures?		
3	Check the records of Near miss, unsafe act, unsafe conditions, and incidents.		
4	Check the organization setup to implement the safety systems at site (safety officer, safety supervisor)		
5	Check whether safety meeting and toolbox talk carried out regularly and records maintained or not.		
6	Is the process of incident investigation adequate or not?		
7	Verify incident reporting and recording system		
8	Check the usage of equipment/tools and tackles.		
9	Check for housekeeping at site		
10	Check the use of PPEs and general behavior of workforce towards safety		
	Total Score		
	Site Visit Score		

Score*- rating on the scale of 1-5 to be given based on the observations on site. Score of 1 is the lowest and core of 5 is the highest.

The Tata Power Company Ltd	     	<i>Contractor's Safety Code of Conduct</i>
<i>Document no TPSMS/GSP/ CSM/015/REV 07</i>		<i>Date of Issue: 01/08/2023</i>

Appendix 14: Indicative List of High-Risk Jobs

Indicative high-risk jobs are given below. This is not an exhaustive list. This is only indicative.

Sl. No.	Jobs
1	Transmission Line Tower Erection on columns, near live lines, In congested areas, In creeks, In the Sea.
2	Conductor Stringing on Tower Using Tensioner & Puller in the area such as Line Crossing, Near Live lines, Congested Areas, Road Crossing, Bridge Crossing, Railway line Crossing, In creeks, In the Sea
3	Cable Pulling by Using winch Machine in City and Rural Areas
4	Hot Washing of HT and Extra HT lines, Towers and switchyards equipment
5	Maintenance / Testing and Replacement of High Voltage (33 KV etc.) Switchyard equipment
6	Installation of Lifts
7	Installation of EOT Cranes
8	Tower Dismantling
9	Working on H Frame /Pole mounted Transformers
10	Excavation in operational Area having power cables in receiving station
11	Identification and spiking of cable / disconnection of cables from poles
12	Working on Electrical Panels
13	Working on live electrical switch yard, Material handling and equipment repair/installation.
14	All activities that require climbing on a pole/structures/Towers/Transformers
15	Cable laying and termination jobs
16	Excavation beyond 5 feet near existing building and structures
17	Working in confined Spaces
18	Stringing of new conductors over poles

The Tata Power Company Ltd	TPCODL		TPNODL	Appendix 3 to CSCC Safety Terms and Conditions
Document No. TPSMS/GSR/STC/009 REV 05	TPSODL	TATA TATA POWER	TPWODL	Date of Issue: 01/08/2023

Appendix 3: Safety Terms and Conditions

Reason for Change	Date of Last Revision	Prepared By	Reviewed By	Approved by
Inclusion of Odisha Discom and periodic Revision	<u>10-Jan-2021-R4</u>	All Discom and CFT members	Debi Prasad Acharya (Head-Safety-Odisha Discom)	Suresh H Khetwani (Chief safety and Environment)

Clause	Sub-clause	Description	Page No
1.0		Objectives	3
2.0		Scope	3
3.0		Safety Organization & Responsibilities	3
	3.1	Contractor Site Management and Supervision	3
	3.2	Contractor Supervisors and General Staff	4
	3.3	Contractor Workforce	4
	3.4	Vendor/Contractor/sub-contractor	5
4.0		<u>Tools and Tackles(R5)</u>	6
5.0		Site Safety Rules and Procedures	6
6.0		Critical safety Rules and Procedures	6
7.0		<u>General Safety Rules and Procedure(R5)</u>	8
8.0		Training and Capability Building	10
9.0		Pre-Employment and Periodic Medical check-up	12
10.0		Safety performance retention(R5) and Safety Performance Evaluation	12
11.0		<u>Recognition to the Prior Learning in Safety-R5</u>	12
12.0		Other Conditions	13
<u>General Safety Conditions for various contracts Specific to Discom(R5)</u>			
13.0		<u>Safety Conditions for maintenance of STS (Sub Transmission System) Network for Discom(R5)</u>	14
14.0		<u>Safety Conditions for maintenance of 11 KV and LT Network for Discom(R5).</u>	15
15.0		<u>Safety Conditions for the major contract work in Civil Projects for Odisha Discom(R5)</u>	16
16.0		<u>Safety Conditions for the major contract work in Commercial Department like - MMG, RRG, EAG, etc(R5)</u>	17
17.0		<u>Safety Conditions for Major Projects in Distribution Network(R5)</u>	18
18.0		<u>Schedule of Safety Audits by BA Safety Staff(R5)</u>	19

The Tata Power Company Ltd	TPCODL	 TATA	TPNODL	Appendix 3 to CSCC Safety Terms and Conditions
Document No. TPSMS/GSR/STC/009 REV 05	TPSODL	 TATA POWER	TPWODL	Date of Issue: 01/08/2023

1.0 Objective:

The Objective of Safety Terms and Conditions is to apprise the Business Associates about various critical procedures of the Tata power Division/Discoms and the expectations from the BA to implement such procedures without fail. Certain terms and conditions are also mentioned to ensure a safe work atmosphere round the year. Refer Contractor's Safety Code of Conduct- Document no TPSMS/GSP/ CSM/015

2.0 Scope:

This procedure applies to all operating and project sites of The Tata Power Company Ltd and Group companies including new businesses like Electric Vehicle charging, Home Automation, Microgrid, Roof top solar etc. This Code of Conduct also applies to all operating and project sites of four Odisha Discoms and New business based on mutually agreed timeline for implementation. R5

3.0 Safety Organization & Responsibilities

3.1 Contractor Site Management and Supervision

Each Contractor will be responsible for fulfilling all statutory and safety requirements as per the laws of the land and not limited to Factory Act, Electricity Act, Electricity Rules and Regulations, Shop and Establishment Act etc.

Each Contractor shall provide at least one competent full-time safety supervisor for workforce of every 50 workers or less than that. When workforce ranges to 500, the contractor must provide at least one qualified safety officer (This may be subjected to change as per applicable act). Thus, for work force of 500 workers there will be one qualified safety officer and 10 safety supervisors. For every 500 additions in workforce, the contractor must add 1 safety officer and 10 safety supervisors. The Order Manager or Safety Department of the Tata Power Division /Discoms will review and approve the appointment of all safety officers and supervisors. The safety supervisors/officers will work with the guidance from Tata Power Division /Discoms Safety Department and align themselves with Tata power Division/Discom safety requirements.

For O&M related AMC activities, minimum one qualified safety officer to be deployed for each Division of the Discoms.

Qualified safety officer means he or she has completed PDIS or ADIS from a recognized institute.

Site Safety Officer/Safety Supervisor / Safety Coordinator shall be interviewed by the Order Manager/ Safety head of the Tata Power Division/Discom and then gate passes shall be issued if the interview is successful.

The Tata Power Company Ltd	 	 	 	Appendix 3 to CSCC Safety Terms and Conditions
Document No. TPSMS/GSR/STC/009 REV 05				Date of Issue: 01/08/2023

Site Manager of Contractor/Subcontractor is responsible, and will be held accountable, for the safety of their own workforce as well as that of sub-contractors. He should also ensure that all equipment, materials, tools, and procedures remain in safety compliance at job site.

Responsibility of Site manager includes, but not limited to:

- 3.1.1 Holding officer/supervisors accountable for safety and actively promote safe work performance.
- 3.1.2 Participate in and cooperate with all safety program requirements to be implemented to meet Tata Power Division /Discoms safety objectives
- 3.1.3 Ensure timely reporting of safety incidents, near misses, unsafe acts, and conditions.
- 3.1.4 Identify the training needs of BA employees and maintain all safety training documents.
- 3.1.5 Provide Safety Performance Report at an agreed frequency.
- 3.1.6 Stopping of unsafe work (Acts and/or Conditions) immediately. Work to start only after corrective actions are implemented.
- 3.1.7 Ensure and participate in daily toolbox talk for all the jobs.
- 3.1.8 Ensure that only tested and certified tools and equipment are issued to the workers and being used at the site.

3.2 Contractor Supervisors and General Staff.

Contractors' site supervisors and general staff members in charge of job site functions such as field engineering, warehousing, purchasing, costing, and scheduling etc. are responsible for the safe performance of the work of those they supervise. They must set an example for their fellow employees by being familiar with applicable sections of the Site Safety program and ensuring that all site activities are performed with SAFETY as the primary objective.

Each site supervisor is responsible and will be held accountable for identifying, analyzing, and eliminating or controlling all hazards through implementation of an aggressive, pro-active Health, Safety and Environmental Program. Each supervisor will proactively participate in the Safety program by observing, correcting, and recording unsafe acts and conditions at plant / sites.

3.3 Contractor Workforce

- 3.3.1 Contractors shall provide adequate quality and quantity of manpower as mutually agreed. (R5)
- 3.3.2 All the contractor employees shall attend "SHE L0(Other than new business and Odisha Discom)/L1 Foundation Course in Safety". Depending on the critical procedure in job employees shall also be required to attend "SHE L2 course of critical/high risk operations". All Supervisors shall be required to attend "SHE L3 Supervisory Training". All the above trainings will be conducted by TPSDI/Skill development institute of Disco, or other equivalent institute approved by Tata Power.

The Tata Power Company Ltd	TPCODL		TPNODL	Appendix 3 to CSCC Safety Terms and Conditions
Document No. TPSMS/GSR/STC/009 REV 05	TPSODL	TATA	TPWODL	Date of Issue: 01/08/2023
TATA POWER				

- 3.3.3 Contractor employees shall be required to attend any other additional training if suggested by Order manager or Site Safety Head. The cost of such additional training shall be borne by the Vendor.
- 3.3.4 Contractor / Vendor shall mobilize their manpower well in advance to complete the training through TPSDI/Sill development Institute.
- 3.3.5 The Vendor / BA shall arrange or bear the conveyance and food expenses incurred during training of BA employees in Odisha Discom. (R5)
- 3.3.6 The validity of the training L1, L2 and L3 is 3 years. There will be competency assessment as Revalidation test in every three months for Tata Power Division and six months for Odisha Discom till one year from implementation of CSCC.(R5) Those who fail in the competency assessment shall undergo training again.
- 3.3.7 Supervisors/Welder/Electricians/Line man /Fitters /Radiographers/Riggers engaged by the contractor shall have valid competency certificates issued by authorized agency/Institute.
- 3.3.8 Contractor workforce must make safety a part of their job by following safety rules and regulations and by using all safeguards and safety equipment. They must take an active part in the Safety programs for the Site.
- 3.3.9 Every member of the workforce is expected to report for work without influence of any Drug/Alcohol. Failure to comply with this requirement shall result in immediate termination of employees under the influence of drug and alcohol plus show cause notice/penalty to the vendor.
- 3.3.10 All employees shall report hazardous conditions, practices and behaviours in their work areas and correct wherever possible.
- 3.3.11 Workforce is responsible for active participation in safety and health programs, suggestion systems, trainings and reporting of unsafe act/practices, Unsafe conditions incidents and injuries to their supervisors.

3.4 Vendor/Contractor/sub-contractor

- 3.4.1 Vendors/Contractor shall always comply with and ensure that their workforce comply with all site safety rules and regulations. Specifically, with applicable provisions of the Site Safety Management Plan and all statutory safety rules and regulations.
- 3.4.2 After receiving the work order/ purchase order vendor/contractor/bidder shall not appoint Sub-contractor without safety assessment of the sub-contractor through safety concurrence group Under Contractor Safety Code of Conduct. Penalty of 5% of contract value will be applicable to the contractor if subcontractor is appointed without the permission of SCG and without evaluation through CSCC process.

The Tata Power Company Ltd	 	 	 	Appendix 3 to CSCC Safety Terms and Conditions
Document No. TPSMS/GSR/STC/009 REV 05				Date of Issue: 01/08/2023

4.0 Tools and Tackles(R5)

- 4.1 Tools & Tackles used to carry out the job shall be checked and inspected by Order Manager and safety Officer.
- 4.2 Vendor must submit a valid Certificate from Competent person under the Factories Act 1948 and State Factories Rule for all Lifting Tools and Tackles (like Hoist, D Shackles, chain Block, wire ropes etc.).
- 4.3 All Electrical Hand Tools must be tested for leakage of current by a person /agency authorized by Tata Power Division /Discoms. Electrical power must be taken though RCCB of 30mA. Electrical hand tools should not have cord more than 3 meters in length. If power source is at > 3 meters, extension boards with RCCB of 30 mA and ON/OFF switch, shall be used.
- 4.4 Removal or inclusion of tools any new tool /tackles / machinery / equipment at site should only be done with concurrence of the order Manager / Head Safety.

5.0 Site Safety Rules and Procedures:

The work in the safest possible manner can only happen when it has been carefully planned and all applicable procedures are followed. The Tata Power Safety Procedures are derived from Tata Power best practices and the applicable Government acts regulations. In each case, the most stringent regulation is used. All safety rules and procedures developed from time to time shall be mandatorily followed by the vendor and his employees while working at Site.

6.0 Critical safety Rules and Procedures: Following is the list of Tata Power's critical Safety Rules and Procedures. Contractor shall refer to approved Rules and Procedures for detailed requirements and ensure conformance

6.1 Lock Out and Tag Out Procedure.

This procedure is intended to be used for the protection of Personnel while servicing or performing maintenance on distribution network/ equipment / pipeline / vessel / process systems. This is a general procedure that shall be used as the minimum requirements for isolation of equipment, pipelines, machines, system from all possible sources of hazardous energy and / or material such as Steam, Hot Water, Compressed Air, any other process fluid / chemical energy /Mechanical energy or Electrical energy. For complete procedure kindly refer Procedure Document No. **TPSMS/CSP/LOTO/001**

6.2 Excavation Safety (Shoring and Sloping) Procedure

This procedure is developed to cover the safe practices required for shoring and sloping in excavation and trenching jobs. This procedure is developed to establish mandatory requirements for practices to protect personnel, property and equipment from hazards associated with above activities. For complete procedure kindly refer Procedure Document No **TPSMS/CSP/EXS/002**

6.3 Confined Space Entry Procedure:

This procedure outlines the steps required to perform the confined space entry and to protect personnel from the hazards of entering and conducting operations in confined spaces. For complete procedure kindly refer Procedure Document No – **TPSMS/CSP/CSE/003**.

The Tata Power Company Ltd	TPCODL	 TATA	Appendix 3 to CSCC Safety Terms and Conditions
Document No. TPSMS/GSR/STC/009 REV 05	TPSODL		Date of Issue: 01/08/2023

6.4 Working at Height Procedure:

This procedure describes the rules and procedures to protect employees from the hazards of working at heights. This procedure is developed to cover the safe practices required for Working at Heights. This procedure is developed to establish mandatory requirements for practices to protect personnel from hazards associated in this area. For complete procedure kindly refer Procedure Document No – TPSMS/CSP/WAH/004.

6.5 Heavy Equipment Movement Safety Procedure.

Heavy equipment lifting and movement is an activity involving loading, unloading, storage and movement from one place to another including lifting and erection or repairing of equipment with cranes or hoists. Material, machinery and equipment handling operations are being carried out by large capacity cranes and hoists, which make the job safer and faster. This procedure addresses the hazards and precautions associated with such equipment and their use. For complete procedure kindly refer Procedure Document No – TPSMS/CSP/HEMS/005.

6.6 Mobile Crane Safety Procedure.

Mobile cranes are responsible for many incidents, injuries. Falling loads from mobile cranes pose a severe hazard to operators and nearby workers and property. Many types of cranes, hoists, and rigging devices are used for lifting and moving materials. To maintain safe, appropriate standards must be adhered to and only qualified and licensed individuals shall operate these devices. For complete procedure kindly refer Procedure Document No – TPSMS/CSP/MCS/006.

6.7 Scaffold Safety Procedure.

This procedure is developed to provide information on the safe erection, use, dismantling and maintenance of access scaffolding in the workplace. It is developed to establish mandatory requirements for practices to protect personnel from hazards associated with erection, use and dismantling of scaffolds. For complete procedure kindly refer Procedure Document No – TPSMS/CSP/SCAF/007.

6.8 Permit to Work Procedure.

Given the inherent hazards of the power generation and distribution industry, a significant number of TATA POWER operations and installations are critical. Work Permit (WP) System is an essential element in controlling the workplace risks in an effective manner. For complete procedure kindly refer Procedure Document No – TPSMS/CSP/PTW/008.

6.9 Job Safety Analysis (JSA) Procedure.

This objective of this procedure is to have a task-based risk assessment process in place that identifies, evaluates and controls the risks associated with work activities, and as a result, prevents those involved in the task or those potentially affected by the task, from being harmed. For complete procedure kindly refer Procedure Document No- TPSMS/CSP/JSA/009 REV 01.

6.10 Electrical Safety Procedure.

The Tata Power Company Ltd	 	 	 	Appendix 3 to CSCC Safety Terms and Conditions
Document No. TPSMS/GSR/STC/009 REV 05				Date of Issue: 01/08/2023

The objective of these standards is to specify minimum mandatory requirements and advisory guidance for identifying and controlling hazards to ensure 'Zero Harm' regarding operation maintenance and testing of electrical equipment. For complete procedure kindly refer Procedure Document No- TPSMS/CSP/ELEC/010

6.11 Fire Safety Management Procedure.

Objective of This standard is to specify the minimum mandatory requirements and advisory guidelines to ensure prevention of fire related incidents and managing / controlling their impacts if they do occur. For complete procedure kindly refer Procedure Document No - TPSMS/CSP/ELEC/011

6.12 Hazard Identification & Risk Assessment (HIRA) Procedure(R5):

Objective of this procedure is to define guidelines for Hazard identification, Risk assessment and determination of controls. For complete procedure kindly refer Procedure Document No - TPSMS/CSP/HIRA/012.

6.13 Management Of Change (MOC) Procedure(R5):

The objective of this document is to establish the procedures necessary to ensure that HSE risks are managed to an acceptable level in Tata Power Management of Change (MOC) process. For complete procedure kindly refer Procedure Document No - TPSMS/CSP/MOC/013.

6.14 Pre-Start-up Safety Review (PSSR) Procedure(R5).

Objective of this procedure is to provide guidelines for safe initial startup of a new facility or restart of a modified facility. The PSSR process verifies that the new/modified facility meets the original design and operating parameters. The intent is to prevent incidents caused by inadequate, incomplete, unauthorized design, construction, installation, and/or commissioning. For complete procedure kindly refer Procedure Document No - TPSMS/CSP/MOC/014.

6.15 Road Safety procedure(R5):

To provide Safety Rules for road travel management and safe usage of all types of vehicles viz. passenger/ commercial, owned/ hired by company, driven by employees or contractors. For complete procedure kindly refer Procedure Document No - TPSMS/CSP/RSP/015.

7.0 General safety Rules and Procedure:

7.1 Lift (Elevator) Safety Procedure:

To provide safe operating procedure for taking control of lift car before entering and existing the pit of OTIS make elevators. For complete procedure kindly refer Procedure Document No – TPSMS/GSP/LIFT/001,

7.2 Working on conveyor belt Procedure:

This procedure is developed to cover the safe practices required for Working on live equipment and to protect personnel from hazards associated with it. For complete procedure kindly refer Procedure Document No – TPSMS/GSP/CONV/003

7.3 Batteries Handling & Disposal(R5)

The Tata Power Company Ltd				Appendix 3 to CSCC Safety Terms and Conditions
Document No. TPSMS/GSR/STC/009 REV 05				Date of Issue: 01/08/2023

To provide procedure for recycling and / or safe disposal of used / waste batteries in compliance with all legislation. For complete procedure kindly refer Procedure Document No – **TPSMS/GSP/HAZM/003**

7.4 Material Handling and Storage Procedure:

The purpose of this document is to provide procedures to assist the safe handling of materials (manual handling and mechanical handling). For complete procedure kindly refer Procedure Document No – **TPSMS/GSP/MATL/004**.

7.5 Office Safety Procedure(R5):

The objective is to provide a safe working environment to those working in office premise, who may be exposed to emergency situations and other chronic / cumulative risks that may arise due to various reasons of unsafe act, unsafe condition, fire and or pandemic crisis like COVID-19 etc. For complete procedure kindly refer Procedure Document No - **TPSMS/GSP/OFS/006**

7.6 Earth Leakage Circuit Breaker (ELCB) Testing Procedure(R5):

The objective of this procedure is to define the minimum requirements for testing of Earth Leakage Circuit Breaker (ELCB). For complete procedure kindly refer Procedure Document No - **TPSMS/GSP/ELCB/008**.

7.7 Occupational Health & Safety Legal Compliance Procedure(R5):

Objective of this procedure is provide guidelines for compliance of Occupational Health & Safety (OH&S) legal requirements and all ratified protocols and agreements are incorporated in Tata Power Safety Management System (SMS). For complete procedure kindly refer Procedure Document No - **TPSMS/GSP/LEGL/009**.

7.8 Incident Reporting & Investigation Procedure(R5):

Objective of this procedure is to outline the process for reporting, recording and investigating an incident, recommending corrective and preventive actions and to communicate the lessons learned to prevent recurrence of similar incidents. For complete procedure kindly refer Procedure Document No - **TPSMS/GSP/IRI/011**.

7.9 Contractor Safety Management Procedure.

The purpose of this document is to engage with contractors in a way to create safe work environment for everyone working for Tata Power. For complete procedure kindly refer Procedure Document No – **TPSMS/GSP/CSM/015**.

7.10 Tree Trimming Procedure(R5):

The objective of this procedure is to define guidelines and minimum requirements for Tree trimming. For complete procedure kindly refer Procedure Document No – **TPSMS/GSP/TTRM/017**

7.11 Safe Lone Working Procedure(R5):

Objective of this procedure is to lay down guidelines for reduction and safe managing of any additional risk arising from lone working. For complete procedure kindly refer Procedure Document No – **TPSMS/GSP/LONE/019**.

7.12 Good Housekeeping(5S) Procedure(R5):

The Tata Power Company Ltd	 	 	 	Appendix 3 to CSCC Safety Terms and Conditions
Document No. TPSMS/GSR/STC/009 REV 05				Date of Issue: 01/08/2023

Objective of this procedure is to explain the meaning, importance and provide guidelines for implementation of Good Housekeeping(5S) at workplaces across organization. For complete procedure kindly refer Procedure Document No – **TPSMS/GSP/GHK/022**.

7.13 Personal Protective Equipment(R5):

This procedure describes the basic requirements, applicability, minimum specifications of Personal Protective Equipment (PPE). For complete procedure kindly refer Procedure Document No – **TPSMS/GSP/PPE/023**.

7.14 Process Safety Management Procedure(R5):

The objective of this document is to provide a standardized & uniform guideline to implement Process Safety Management in Tata Power, its JVs, and subsidiaries to prevent or minimize the consequences of releases of toxic, flammable, pressurized or uncontrolled chemicals/Steam/Water or any other material which may result in toxic, fire, explosion, burn or flood like situation. For complete procedure kindly refer Procedure Document No – **TPSMS/GSP/PSM/024**

The above procedures will be updated time to time and the updated version of the procedures as well as any additional critical procedure will be available on official website of Tata Power (www.tatapower.com) for your reference.

8.0 Training and Capability Building.

Safety Training and capability building of workforce is a major component of safety management program. All training required must be provided and documented as specified by Tata Power and Indian Regulations. Tata Power Division /Discoms Safety department will audit contractors training and related documentation to assure its adequacy.

8.1 Tata power Odisha Discom Site Safety Orientation.R5

All Tata Power contractor and subcontractor workforce is required to attend Site Safety Orientation Training to receive a Safety Training Card, which is required to obtain a Gate Pass to the site, prior to entry. This Safety Orientation Course will be for duration of minimum half day. The information provided during the orientation will include, but is not limited to following:

- 8.1.1 Job rules, personal safety, and conduct
- 8.1.2 Hazard's reporting
- 8.1.3 Reporting of injuries
- 8.1.4 Emergency procedures
- 8.1.5 Safety Activities and Program including disciplinary measure and incentives.
- 8.1.6 Critical safety procedure relevant to the job

8.2 Capability Building:

- 8.2.1 All Tata Power contractor and subcontractor workforce is required to attend L1 Training to receive a Safety Training Card, which is required to obtain a Gate Pass to the site, prior to entry.
- 8.2.2 Appropriate practical training such as SHE L1, L2& L3 is given to ensure that a jobholder, either supervisor or worker, is competent to do his/her job safely. The skill training is provided through TPSDI, and other agencies authorized

The Tata Power Company Ltd	 	 	 	Appendix 3 to CSCC Safety Terms and Conditions
Document No. TPSMS/GSR/STC/009 REV 05				Date of Issue: 01/08/2023

by Tata Power on the list of 15 critical Safety procedures mentioned under safety procedures. Duration of course is as specified by Division/Discom

- 8.2.3** Contractor shall ensure that concerned workmen are provided with adequate training before he/she is allowed to execute the work. An evaluation test will be conducted after the completion of the training. Those employees who meet the minimum required competency will be provided with Certificate (Card), which will be valid for 3 years, post which the workmen have to reappear for assessment.
- 8.2.4** If the workman is not able to qualify the assessment, he/she will be given 3 additional attempts to clear in 3-month time failing which he/she will not be allowed to work in the Division /Discoms.
- 8.2.5** After expiry of Certificate or Training /Competency Card again one day recertification of L1, L2 and L3 skill training will be provided. R7.
- 8.2.6** Quarterly /Half yearly(For Odisha and New business) Revalidation Test - "SHE L1 Revalidation test" will be conducted for the contractor's employees to revalidate their safety awareness and knowledge.
- 8.2.7** Order Manager and Safety In charge of the Division/Site /Plant will conduct a Competency Assessment of all workforces, going to be deployed at site / plant for high-Risk job.
- 8.2.8** The Contactor shall bear the conveyance and food expenses of his staff for attending training sessions and capability building sessions in new business-like Odisha Discom.
- 8.2.9** The Contactor shall bear the entire cost of L1/L2/L3, the costs towards training, salaries/wages, boarding and lodging of his staff for attending training sessions and capability building sessions. These trainings are offered on nominal chargeable basis payable by Contractor and rates shall be decided by TPSDI from time to time in case of training through TPSDI. Generally, L0 is of one day, L1 is for 2 days for each critical procedure and L3 is for one day. Around Rs 700+GST is approx. cost /Day/Candidate. -R5
- 8.2.10** Competency assessment of all critical workforce to be carried out for all who has taken L2 training. R5

9.0 Recognition to the Prior Learning in Safety-R5

If "Order Manager" recommends and "Head of the Safety Department of Discom" is satisfied with the safety knowledge and competency of the employee of contractor, a test may be conducted by Tata power Skill development Institute/ other recognized institute to assess the prior learning in safety. If employees of the contractors pass in such test, he will be exempted from appearing in SHE L1 training. This assessment is on nominal chargeable basis and rates are decided by TPSDI from time to time.

10.0 Safety performance retention(R5) and Safety Performance Evaluation: A certain percentage of the bill value will be retained against every running bill as safety performance retention. The amount will be released with the last invoice or every six-month based on Safety Performance Score of contractors. This is as per CSCC Document no TPSMS/GSP/ CSM/015

The Tata Power Company Ltd	 	 	 	Appendix 3 to CSCC Safety Terms and Conditions
Document No. TPSMS/GSR/STC/009 REV 05				Date of Issue: 01/08/2023

This safety retention shall be waived for Contractors who have either submitted a Contract Performance Bank Guarantee or have a retention from each running bill for an amount not less than 10% of each bill subject to the express undertaking / understanding that if there are any deductions required to be made for safety non-performance as per the Safety Performance Score, then Tata Power shall recover any such deductions against safety non-performance directly from the monthly bills / final settlement as the case may be failing which it shall be within its right to recover such sum from accounts payable or the CPBG or the retention of the Contractor available with Tata Power for the said contract or any other contract between the Contractor and Tata Power.

11.0 Pre-Employment and Periodic Medical check-up:

Contractor shall arrange to conduct a pre-employment and periodic medical check-up for its entire workforce by Tata Power medical officer or Tata Power authorized medical officer. The contractor shall be able to produce the certificate prior to the employment. The contractor shall also organize to conduct periodical medical checkup (six monthly) for the following category of employees:

- Drivers (Check for Vision & Hearing)
- HEM Equipment Operators (Check for Vision & Hearing)
- Workforce working at Height (Check for Vision, Hearing, Vertigo & Height Phobia)
- Workforce Handling the hazardous substances - Coal, ash and chemicals (Chest X-ray and Lung Function T)
- Workforce in high Noise area (> 90 Decibel), Check for Hearing
- Workforce handling radiography equipment for conducting NDT.
- Workforce, working in specific areas requiring specific medical attention should conduct the medical tests test as laid down in the respective Site Safety Management Plan.

12.0 Other Conditions:

- 12.1. The manpower/vehicles/Tools & Tackles/Equipment provided shall be as per mutually agreed SLA.
- 12.2. No Supervision No work policy should strictly be followed.
- 12.3. Test Before Touch must be ensured every time a job is being carried out in electrical network.
- 12.4. HIRA /JSA as per the job scope must be prepared in detail and submitted along with Site Safety Plan by the successful bidder.
- 12.5. Personal protective equipment (PPE) must always be checked before use to ensure that they are in good condition and clean. Replace them if necessary.
- 12.6. All relevant PPE shall be provided by the vendor while working at the site.
- 12.7. Housekeeping shall be maintained all the time while execution of work. All the unwanted material shall be removed from the site at the end of the day's work. Old/damaged parts if taken out of the system shall be kept at

The Tata Power Company Ltd	TPCODL	 TATA	TPNODL	Appendix 3 to CSCC Safety Terms and Conditions
Document No. TPSMS/GSR/STC/009 REV 05	TPSODL	TATA POWER	TPWODL	Date of Issue: 01/08/2023

identified placed and it shall be shifted to scrap yard or disposed of as per instruction of order manager.

- 12.8. Site Safety Plan shall be prepared by successful bidder along with order manger. Appendix 1 to be filled by successful bidder and submitted to Tata Power safety in-charge, before mobilization of team at site and start of the work.
- 12.9. The Owner or Proprietor of BA must visit worksite at least once in a month and meet Order Manager every month. In case of incidents, the Owner or Proprietor of BA is required to attend Time Out Meetings to understand the gaps that contributed to the incident.

CONFIDENTIAL

The Tata Power Company Ltd				Appendix 3 to CSCC Safety Terms and Conditions
Document No. TPSMS/GSR/STC/009 REV 05				Date of Issue: 01/08/2023

General Safety Conditions for various contracts Specific to Odisha Discom(R5)

13.0. Safety Conditions for maintenance of STS (Sub Transmission System) Network.

A BA awarded a major contract work of maintenance of sub – transmission network in area of a power system will be required to fulfil the following conditions:

- Availability of Discharge Rods - Minimum 6 Nos. in each maintenance vehicle, fit for purpose and in good conditions and defective rods are removed from service.
- Availability of Neon tester - Minimum one Neon Tester in each Maintenance Vehicle, in good and working condition and defective or non-standard neon testers are removed from service.
- Electrical hand Gloves - Minimum two sets of 33 KV and two sets of 11 KV in maintenance vehicles.
- The BA linemen must be having required ELBO certification for the voltage level involved.
- BA shall provide Safety Policy, Safety Objectives, Organogram showing structure and responsibility of Safety management of his company and shall document the work practices and procedures in terms of Safety Management.
- BA shall comply with all statutory requirements like applicable acts, regulations, codes of practice, OHSAS Standards, Labour laws, etc.
- The BA shall participate in Safety promotional activities like celebration of Lineman day on 4th March, National Fire Service Day on 14th April and Theme based safety campaigns undertaken by the Discoms every month.
- BA shall abide by Safety manuals and guidelines of Discom issued from time to time.
- BA shall ensure safety training and induction program for the employees. The BA employees must carry safety training card / competency card to the worksite and produce the card on demand.
- All BA employees must be given valid ID card issued by BA cell of Discom who will check statutory compliances before issuing ID cards.
- BA shall not employ a new workman without training and issue of ID card.
- BA shall conduct safety audits & inspections as per Discom procedures.
- BA shall provide proper PPEs as per CSM F-8 ensure periodic inspection of PPE, Tools and tackles to ensure their serviceability.
- BA shall ensure the adherence to standard operating procedures or guidelines laid down by the Discoms.
- BA shall ensure that no job shall be carried out without efficient supervision.
- BA shall ensure reporting of any unsafe act, unsafe conditions, near miss, incident, or accident to engineer in-charge and SAFETY team of the Discom.
- BA shall provide safety performance and Safety MIS to engineer in-charge and Discom SAFETY group periodically. Based on any non-confirmation to the safety procedures and guidelines, BA is liable to be negatively marked for his performance and suitable penalty will be imposed.
- BA safety staff shall work as per the guidance of the Discom safety department and functionally report Safety Head of Discom. Any leaves by safety staff of the BA shall have to approved by Discom Safety Department.
- BA shall ensure to depute Safety Staff for managing safety in worksites. In case the BA has been awarded work in more than one area power system, then the following safety structure will be adopted.
- Safety manager and Safety engineer must be having PDIS or ADIS.

The Tata Power Company Ltd	TPCODL	 TATA	TPNODL	Appendix 3 to CSCC Safety Terms and Conditions
Document No. TPSMS/GSR/STC/009 REV 05	TPSODL	 TATA POWER	TPWODL	Date of Issue: 01/08/2023



14.0 Safety Conditions for maintenance of 11 KV and LT Network.

A BA awarded a major contract work of maintenance of 11 KV and LT Network in area of a power system will be required to fulfil the following conditions:

- Availability of Discharge Rods - Minimum 6 Nos. in each PSS/FCC and maintenance vehicle, fit for purpose and in good conditions and defective rods are removed from service.
- Availability of Neon tester - Minimum one Neon Tester in each PSS/FCC/ Maintenance Vehicle, in good and working condition and defective or non-standard neon testers are removed from service.
- Electrical hand Gloves - Minimum two sets of 33 KV and two sets of 11 KV in each PSS/Maintenance vehicles and two sets of LT hand gloves at each FCC.
- The BA linemen must be having required ELBO certification for the voltage level involved.
- BA shall provide Safety Policy, Safety Objectives, Organogram showing structure and responsibility of Safety management of his company and shall document the work practices and procedures in terms of Safety Management.
- BA shall comply with all statutory requirements like applicable acts, regulations, codes of practice, OHSAS Standards, Labour laws, etc.
- BA shall abide by Safety manuals and guidelines of Discom issued from time to time.
- BA shall ensure safety training and induction program for the employees. The BA employees must carry safety training card / competency card to the worksite and produce the card on demand.
- All BA employees must be given valid ID card issued by BA cell of Discom who will check statutory compliances before issuing ID cards.
- BA shall not engage new workman without training and issue of ID card.
- PSS operator shall not be involved in maintenance activities.
- BA shall conduct safety audits & inspections as per Discom procedures.
- BA shall provide proper PPEs as per CSM F-8 ensure periodic inspection of PPE, Tools and tackles to ensure their serviceability.
- The BA shall participate in Safety promotional activities like celebration of Lineman day on 4th March, National Fire Service Day on 14th April and Theme based safety campaigns undertaken by the Discoms every month.
- BA to ensure that all LT complaints are routed through Call Centre and recorded in FCC. Rectification of fault shall be done only after call centre logging and with the knowledge of BA supervisor.
- No one will work alone or unsafely under public pressure or otherwise.
- BA shall ensure the adherence to standard operating procedures or guidelines laid down by the Discoms.
- BA shall ensure that no job shall be carried out without efficient supervision.

The Tata Power Company Ltd	 	 	 	Appendix 3 to CSCC Safety Terms and Conditions
Document No. TPSMS/GSR/STC/009 REV 05				Date of Issue: 01/08/2023

- BA shall ensure reporting of any unsafe act, unsafe conditions, near miss, incident, or accident to engineer in-charge and SAFETY team of the Discom.
- BA shall provide safety performance and Safety MIS to engineer in-charge and Discom SAFETY group periodically. Based on any non-confirmation to the safety procedures and guidelines, BA is liable to be negatively marked for his performance and suitable penalty will be imposed.
- BA safety staff shall work as per the guidance of the Discom safety department and functionally report Safety Head of Discom. Any leaves by safety staff of the BA shall have to approved by Discom Safety Department.
- BA shall ensure to depute Safety Staff - One safety supervisor per section, One safety engineer per sub-division and one safety manager per Division Safety manager and Safety engineer must be having PDIS or ADIS.

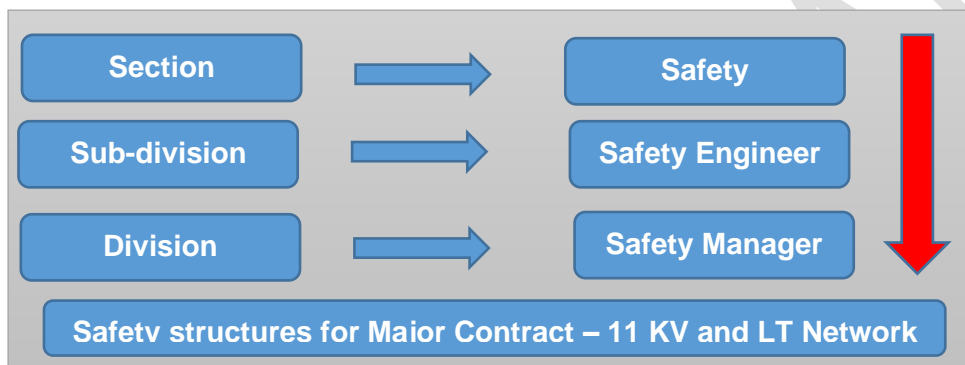

15.0 **Safety Conditions for the major contract work in Civil Projects:**

A BA awarded a major contract work of / in civil project will be required to fulfil the following safety conditions:

- BA shall provide Safety Policy, Safety Objectives, Organogram showing structure and responsibility of Safety management of his company and shall document the work practices and procedures in terms of Safety Management.
- BA shall comply with all statutory requirements like applicable acts, regulations, codes of practice, OHSAS Standards, Labour laws, etc.
- BA shall abide by Safety manuals and guidelines of Discom issued from time to time.
- BA shall ensure safety training and induction program for the employees. The BA employees must carry safety training card / competency card to the worksite and produce the card on demand.
- All BA employees must be given valid ID card issued by BA cell of Discom who will check statutory compliances before issuing ID cards.
- BA shall not employ a new workman without training and issue of ID card.
- BA shall conduct safety audits & inspections as per Discom procedures.
- BA shall provide proper PPEs as per CSM F-8 ensure periodic inspection of PPE, Tools and tackles to ensure their serviceability.
- BA shall ensure the adherence to standard operating procedures or guidelines laid down by the Discoms.
- BA shall ensure that no job shall be carried out without efficient supervision.
- BA shall ensure reporting of any unsafe act, unsafe conditions, near miss, incident, or accident to engineer in-charge and SAFETY team of the Discom.

The Tata Power Company Ltd		Appendix 3 to CSCC Safety Terms and Conditions
Document No. TPSMS/GSR/STC/009 REV 05		Date of Issue: 01/08/2023

- The BA shall participate in Safety promotional activities like celebration of Lineman day on 4th March, National Fire Service Day on 14th April and Theme based safety campaigns undertaken by the Discoms every month.
- BA shall provide safety performance and Safety MIS to engineer in-charge and Discom SAFETY group periodically. Based on any non-confirmation to the safety procedures and guidelines, BA is liable to be negatively marked for his performance and suitable penalty will be imposed.
- BA safety staff shall work as per the guidance of the Discom safety department and functionally report Safety Head of Discom. Any leaves by safety staff of the BA shall have to approved by Discom Safety Department.
- BA shall refer Construction Safety Manual of the Discom for details.
- BA shall ensure to depute a Safety Supervisor (for workforce up to 100 at site) / a safety engineer (for workforce up to 250 at site) / safety manager (for more than two safety engineers) for managing safety at the project site. In case the BA has been awarded more than one major contracts, then the following safety structure will be adopted.
- Safety Engineers and Safety Managers must be having PDIS or ADIS.



16.0 Safety Conditions for the major contract work in Commercial Department like - MMG, RRG, EAG, etc.:

A BA awarded a major contract work in meter management group & energy auditing group will be required to fulfil the following safety conditions:

- BA shall provide Safety Policy, Safety Objectives, Organogram showing structure and responsibility of Safety management of his company and shall document the work practices and procedures in terms of Safety Management.
- BA shall comply with all statutory requirements like applicable acts, regulations, codes of practice, OHSAS Standards, Labour laws, etc.
- BA shall abide by Safety manuals and guidelines of Discom issued from time to time.
- BA shall ensure safety training and induction program for the employees. The BA employees must carry safety training card / competency card to the worksite and produce the card on demand.
- All BA employees must be given valid ID card issued by BA cell of Discom who will check statutory compliances before issuing ID cards.
- BA shall not employ a new workman without training and issue of ID card.
- BA shall conduct safety audits & inspections as per Discom procedures.
- The BA shall participate in Safety promotional activities like celebration of Lineman day on 4th March, National Fire Service Day on 14th April and Theme based safety campaigns undertaken by the Discoms every month.
- BA shall provide proper PPEs as per CSM F-8 ensure periodic inspection of PPE, Tools and tackles to ensure their serviceability.

The Tata Power Company Ltd	TPCODL		TPNODL	Appendix 3 to CSCC Safety Terms and Conditions
Document No. TPSMS/GSR/STC/009 REV 05	TPSODL		TPWODL	Date of Issue: 01/08/2023

- BA shall ensure the adherence to standard operating procedures or guidelines laid down by the Discoms.
- BA shall ensure that no job shall be carried out without efficient supervision.
- BA shall ensure reporting of any unsafe act, unsafe conditions, near miss, incident, or accident to engineer in-charge and SAFETY team of the Discom.
- BA shall provide safety performance and Safety MIS to engineer in-charge and Discom SAFETY group periodically. Based on any non-confirmation to the safety procedures and guidelines, BA is liable to be negatively marked for his performance and suitable penalty will be imposed.
- BA safety staff shall work as per the guidance of the Discom safety department and functionally report Safety Head of Discom. Any leaves by safety staff of the BA shall have to be approved by Discom Safety Department.
- BA shall ensure to depute a Safety Supervisor for managing safety at worksite.
- The BA for the RRG work shall depute one Safety supervisor.



17.0 Safety Conditions for Major Projects in Distribution Network

A BA awarded a major Projects in Distribution Network shall be required to fulfil the following conditions:

- Availability of Discharge Rods - Minimum 6 Nos. for each project site, fit for purpose and in good conditions and defective rods are removed from service.
- Availability of Neon tester - Minimum one Neon Tester in each project site, in good and working condition and defective or non-standard neon testers are removed from service.
- Electrical hand Gloves - Minimum one sets of 33 KV, 11 KV and LT in each project site.
- The BA linemen must be having required ELBO certification for the voltage level involved.
- BA shall provide Safety Policy, Safety Objectives, Organogram showing structure and responsibility of Safety management of his company and shall document the work practices and procedures in terms of Safety Management.
- BA shall comply with all statutory requirements like applicable acts, regulations, codes of practice, OHSAS Standards, Labour laws, etc.
- BA shall abide by Safety manuals and guidelines of Discom issued from time to time.
- BA shall ensure safety training and induction program for the employees. The BA employees must carry safety training card / competency card to the worksite and produce the card on demand.
- The BA shall participate in Safety promotional activities like celebration of Lineman day on 4th March, National Fire Service Day on 14th April and Theme based safety campaigns undertaken by the Discoms every month.
- All BA employees must be given valid ID card issued by BA cell of Discom who will check statutory compliances before issuing ID cards.
- BA shall not employ a new workman without training and issue of ID card.
- BA shall conduct safety audits & inspections as per Discom procedures.
- BA shall provide proper PPEs as per CSM F-8 ensure periodic inspection of PPE, Tools and tackles to ensure their serviceability.

- BA shall ensure the adherence to standard operating procedures or guidelines laid down by the Discoms.
- BA shall ensure that no job shall be carried out without efficient supervision.

Sr. No	Type of Audit	Frequency
1	Tool Bag and PPE audit	Weekly
2	First Aid Box Maintenance Record	Fortnightly
3	Fire Extinguisher Record (Applicable for the BA involved in major construction works and have storage of flammable material at worksite)	Monthly
4	Safety Talk Register	Weekly
5	Site Safety Audit	Daily

- BA shall ensure reporting of any unsafe act, unsafe conditions, near miss, incident, or accident to engineer in-charge and SAFETY team of the Discom.
- BA shall provide safety performance and Safety MIS to engineer in-charge and Discom SAFETY group periodically. Based on any non-confirmation to the safety procedures and guidelines, BA is liable to be negatively marked for his performance and suitable penalty will be imposed.
- The BA shall participate in Safety promotional activities like celebration of Lineman day on 4th March, National Fire Service Day on 14th April and Theme based safety campaigns undertaken by the Discoms every month.
- BA safety staff shall work as per the guidance of the Discom safety department and functionally report Safety Head of Discom. Any leaves by safety staff of the BA shall have to approved by Discom Safety Department.
- BA shall ensure to depute Safety Staff for managing safety in worksites. One safety supervisor per project site or 100 persons, one safety engineer for 2 project sites of 250 persons, and one safety manager for four project sites or 500 persons.
- Safety manager and Safety engineer must be having PDIS or ADIS.

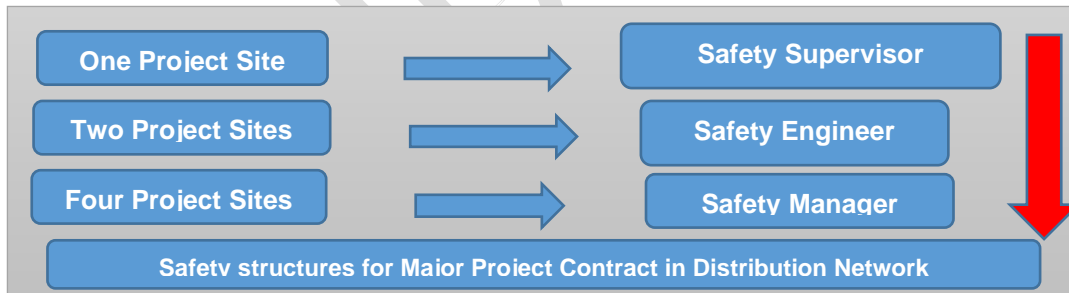

18.0 Schedule of Safety Audits by BA Safety Staff

Safety Undertaking of BA by way of Affidavit

I _____ s/o _____ R/o _____ (AUTHORIZED REPRESENTATIVE/PARTNER/DIRECTOR/PROPRIETOR) of M/S _____ (name of company/firm) having its office at (Complete address of Company), authorized vide power

The Tata Power Company Ltd	TPCODL	 TATA	Appendix 3 to CSCC Safety Terms and Conditions
Document No. TPSMS/GSR/STC/009 REV 05	TPSODL	 TATA POWER	Date of Issue: 01/08/2023

of attorney dated -----/Board resolution dated----/letter of authority dated----, hereinafter referred to as **Contractor [or Business Associate (BA)]** which expression shall, unless it be repugnant to or inconsistent with the meaning or context thereof, be deemed to include its heirs, executors, administrators, and assigns do hereby affirm and undertake as under :

1. The present undertaking shall remain in force from the date of execution of contract and shall be valid till the date of termination of the said contract by either party. The undertaking is binding on me (contractor) as well as my sub-contractor and its employees, representatives etc.
2. That I (the contractor) will be responsible and liable to comply and abide by all the safety rules, instructions and regulations as may be specified and laid down by the Discom to achieve its goal of Zero for on-site incidences.
3. That the Contractor shall be fully responsible for ensuring occupational health and safety of its employees, representatives, agents as well as of its subcontractor's employees, at all times during the discharge of their respective obligations under the contract including any methods adopted for performance of their tasks / work.
4. That Contractor shall ensure ,at its own expense to arrange for and procure, implement all requisite accident prevention tools, first aid boxes, personal protective equipment, fire extinguisher, safety training, Material Safety Data Sheet, pre-employment medical test, etc. for operations & activities including as & when so specified by Discom specifically. , failing which Discom shall be entitled, but not obliged, to provide the same and recover the actual cost thereof from the Contractor's payments.
5. That the Contractor shall engage adequate and competent Safety – Supervisor / Engineer / Manager / Skilled persons at site as per the Para 5 (Qualification and experience of safety personnel) and Annexure 3 of Contract Safety Management.
6. That the Contractor shall engage the competent Site – Supervisor with each group of workers for safe and correct workmanship, proper co-ordination of material and site work as per contract.
7. That the Contractor shall immediately replace supervisor in case it is found to be not up to the level of skill and experience required, but any such replacement shall be only with the prior concurrence of the Discom representative.

The Tata Power Company Ltd	TPCODL	 TATA	TPNODL	Appendix 3 to CSCC Safety Terms and Conditions
Document No. TPSMS/GSR/STC/009 REV 05	TPSODL	 TATA POWER	TPWODL	Date of Issue: 01/08/2023

8. That the Contractor and its subcontractors shall abide by all the safety guidelines as per Safety Manual, Contract Safety Management and other guidelines issued from time to time by Discom during the contract period.
9. That in case the Contractor and/or any of its Subcontractor fail to ensure the compliance as required in terms of this undertaking the Contractor shall keep and hold Discom / its directors / officers / employees indemnified against any / all losses / damage / expense / liability / fines / compensation / claims / action / prosecutions or the like which might be suffered by Discom or to which Discom might get exposed to as a result of any breach /wilful negligence /deliberate default on the part of the Contractor /Subcontractor in complying with the same. Contractor shall also furnish any press release, clarification etc. if sought by Discom for any near miss or safety violations, accidents, which are attributable to fault of Contractor.

DEPONENT

VERIFICATION

Verified aton this _Day of _____ 20__ that the contents of the above affidavit are true and correct and nothing material has been concealed therefrom

CONFIDENTIAL

Annexure IX

Tata Code of Conduct (TCoC)

TATA CODE OF CONDUCT

The Owner abides by the Tata Code of Conduct in all its dealing with stake holders and the same shall be binding on the Owner and the Contractor for dealings under this Order/ Contract. A copy of the Tata Code of Conduct is available a tour website:

<https://www.tatapower.com/pdf/aboutus/Tata-Code-of-Conduct.pdf>

The Contractor is requested to bring any concerns regarding this to the notice of our Chief Procurement & Stores e-mailID: pravin.jain@tpcentralodisha.com.

Annexure X

Environment & Sustainability Policy

ENVIRONMENT & SUSTAINABILITY POLICY



CORPORATE ENVIRONMENT POLICY

Tata Power is committed to a clean, safe and healthy environment, and we shall operate our facilities in an environmentally sensitive and responsible manner. Our commitment to environmental protection and stewardship will be achieved by:

- Complying with the requirements and spirit of applicable environmental laws and striving to exceed required levels of compliance wherever feasible
- Ensuring that our employees are trained to acquire the necessary skills to meet environmental standards
- Conserving natural resources by improving efficiency and reducing wastage
- Making business decisions that aim towards sustainable development
- Engaging with stakeholders to create awareness on sustainability

A handwritten signature in blue ink, appearing to read 'Praveer Sinha', with a horizontal line underneath.

(Praveer Sinha)
CEO & Managing Director

Date: 15th June, 2018

TATA POWER
Lighting up Lives!





CORPORATE SUSTAINABILITY POLICY

At **Tata Power**, our Sustainability Policy integrates economic progress, social responsibility and environmental concerns with the objective of improving quality of life. We believe in integrating our business values and operations to meet the expectations of our customers, employees, partners, investors, communities and public at large

- We will uphold the values of honesty, partnership and fairness in our relationship with stakeholders
- We shall provide and maintain a clean, healthy and safe working environment for employees, customers, partners and the community
- We will strive to consistently enhance our value proposition to the customers and adhere to our promised standards of service delivery
- We will respect the universal declaration of human rights, International Labour Organization's fundamental conventions on core labour standards and operate as an equal opportunities employer
- We shall encourage and support our partners to adopt responsible business policies, Business Ethics and our Code of Conduct Standards
- We will continue to serve our communities:
 - By implementing sustainable Community Development Programmes including through public/private partnerships in and around our area of operations
 - By constantly protecting ecology, maintaining and renewing bio-diversity and wherever necessary conserving and protecting wild life, particularly endangered species
 - By encouraging our employees to serve communities by volunteering and by sharing their skills and expertise
 - By striving to deploy sustainable technologies and processes in all our operations and use scarce natural resources efficiently in our facilities
 - We will also help communities that are affected by natural calamities or untoward incidence, or that are physically challenged in line with the Tata Group's efforts

The management will commit all the necessary resources required to meet the goals of Corporate Sustainability.

(Praveer Sinha)
CEO & Managing Director

Date: 15th June, 2018

TATA POWER
Lighting up Lives!



ANNEXURE-XII

MANUAL ARIBA - E - AUCTION



**SUPPLIER MANUAL ANSWERING
TO
E-BIDDING & E-AUCTION**

CELEBRATING 100 YEARS OF INVISIBLE GOODNESS

TATA POWER

Company Confidential	Version 1.1 DEC - 2016
----------------------	---------------------------

INDEX

1 ACCESSING ARIBA SOURCING	3
2 VENDOR SCREEN.....	4
3 SUBMITTING YOUR ANSWERS / PROPOSAL.....	4
<i>3.1.1 Review and Approve “Prerequisites”</i>	<i>6</i>
<i>3.1.2 Select Items or Lots</i>	<i>6</i>
<i>3.1.3 Entering Your Prebid</i>	<i>7</i>
<i>3.1.4 Entering Your Prebid for e-auction.....</i>	<i>8</i>
<i>3.1.5 Participate to the e-auction</i>	<i>9</i>
3.1.5.1 How to submit a price.....	9
3.1.5.2 What to do If you have a problem during the e-auction?	10
4 COMMUNICATING WITH UPM NEGOTIATOR.....	10
5 SUPPLIER FREQUENTLY ASKED QUESTION	11

1- Accessing Ariba Sourcing

Step 1: You will get an invitation to your email from Ariba System. Keep this email, it contains your login Information and a direct link to Ariba.

Step 2: Click "Click Here" to access the Ariba Web Site.

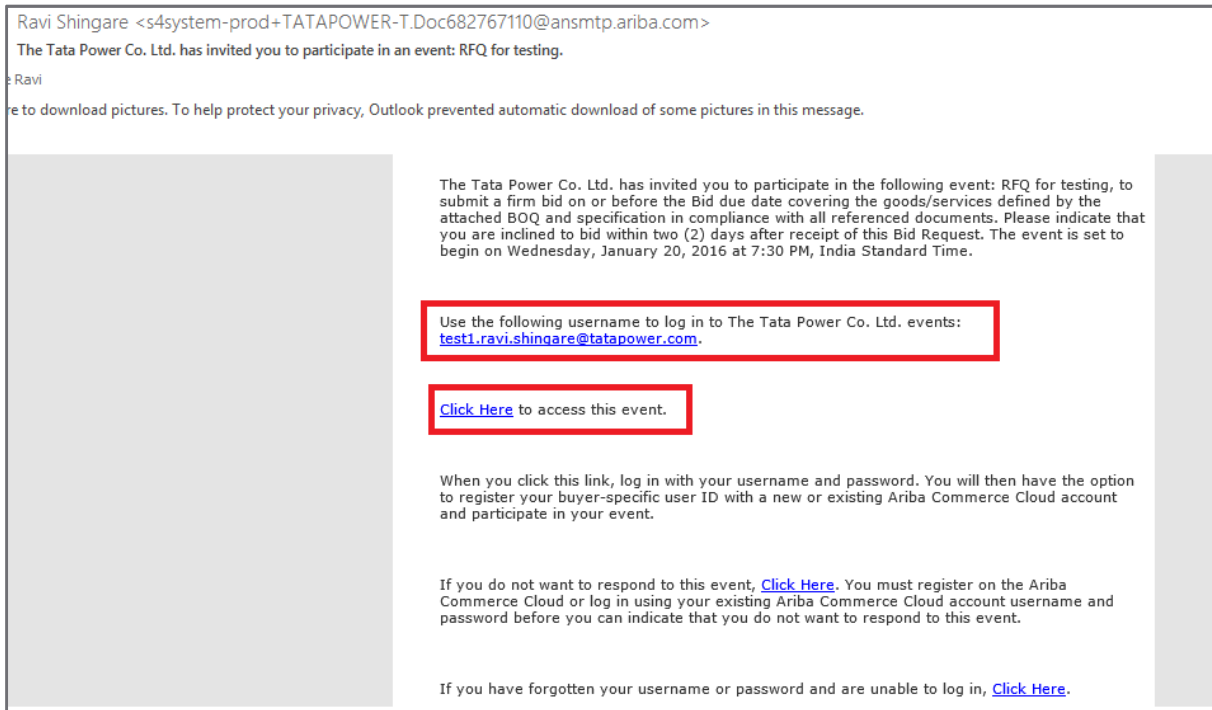

Step 3: Supplier has to click on "Continue"

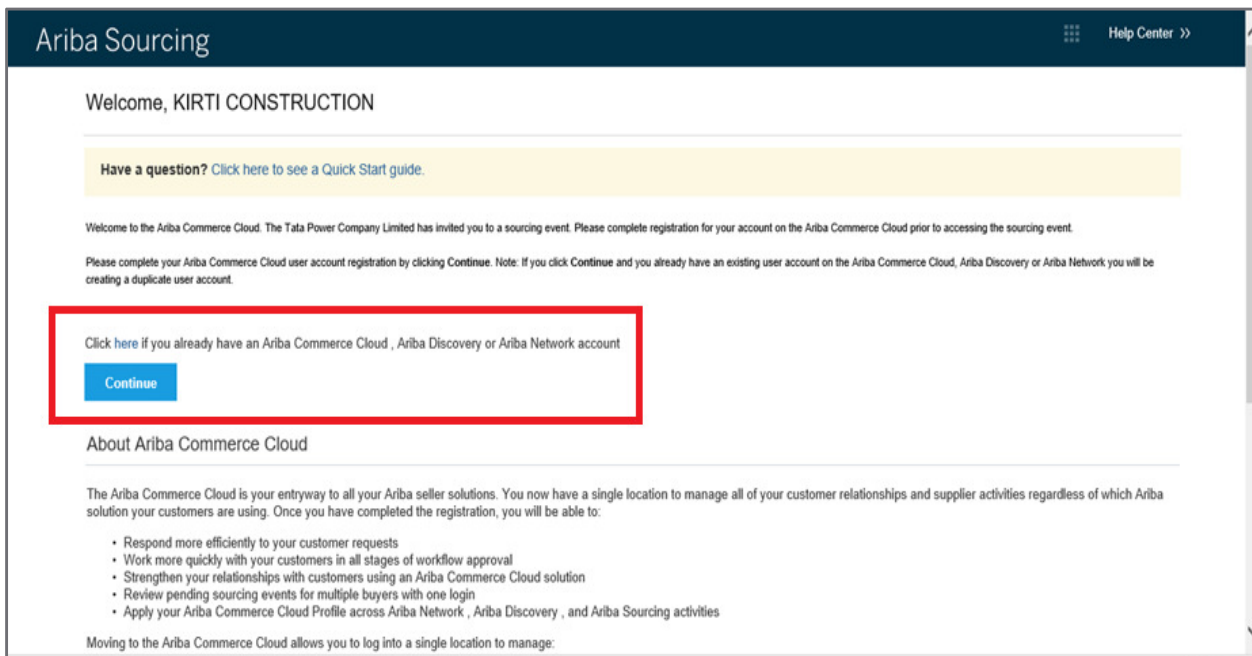

Step 4: The registration process only takes a few moments, with a simple one-page registration. Define your password and secret question. Click “OK”

* Indicates a required field

Company Name*

Country* If your company has more than one office, enter the main office address. You can enter more addresses such as your shipping address, billing address or other addresses later in your company profile.

Address*

City*

State

Postal Code*

Product and Service Categories* -or-

Ship-to or Service Locations* -or-

Tax ID: Enter your Company Tax ID number.

DUNS Number: Enter the nine-digit number issued by Dun & Bradstreet. ⓘ

Supplier has to fill the form

 **ARIBA*** SPEND MANAGEMENT Help | Logout

Welcome USER_TEST2 - UPM-Kymmene Corporation

Expired Password

Your password has expired. Follow these instructions to complete this step: Create a new password and confirm. Select a secret question and answer it so ...

Passwords are case-sensitive, and must be between 8 and 16 characters long. They can include any Latin characters and punctuation marks, and must include at least one numeral between the first and last character. They must also include at least one letter. For example, go2enba.

The current secret answer that you have entered is different from the one that has been recorded for this user.

New Password*

New Password (confirm)*

Secret Question* ⓘ

Secret Answer*

(*) indicates a required field

You expressly agree and understand that your data entered into this system may be transferred outside of the European Union or other jurisdiction where you are located, as further described in the Ariba Data Policy [Data Policy](#)

Step 5: If it's the first time you are invited to use UPM Ariba, you'll need to accept the “Participant Terms”. Select “I accept the terms of this agreement”. Click “Submit”.

Secret Question* The answer to your secret question must be atleast 5 characters.

Language: The language used when Ariba sends you configurable notifications. This is different than your web b...

Ariba will make your company profile, which includes the basic company information, available for new business opportunities to other companies. If you want to hide your company profile, you can do so anytime by editing the profile visibility settings on the Company Profile page after you have finished your registration.

By clicking the Submit button, you expressly acknowledge and give consent to Ariba for your data entered into this system to be transferred outside the European Union, Russian Federation or other jurisdiction where you are located to Ariba and the computer systems on which the Ariba services are hosted (located in various data centers globally), in accordance with the Ariba Privacy Statement, the Terms of Use, and applicable law.

You have the right to access and modify your personal data from within the application, by contacting the Ariba administrator within your organization or Ariba, Inc. This consent shall be in effect from the moment it has been granted and may be revoked by prior written notice to Ariba. If you are a Russian citizen residing within the Russian Federation, You also expressly confirm that any of your personal data entered or modified in the system has previously been captured by your organization in a separate data repository residing within the Russian federation.

I have read and agree to the [Terms of Use](#) and the [Ariba Privacy Statement](#)

2 Vendor Screen

2.1.1 If vendor goes through mail invitation then directly Screen 3.1.1 will appear, but if you have used Ariba before and have already accessed an event for the buyer-specific account with your current log in ID, click the **Login** button to continue. Log in with your Ariba username and password in order to participate in the event OR you have to follow the following steps.

Step 1 - Log on supplier.ariba.com

Step 2 - Put your USER ID and Password in following screen

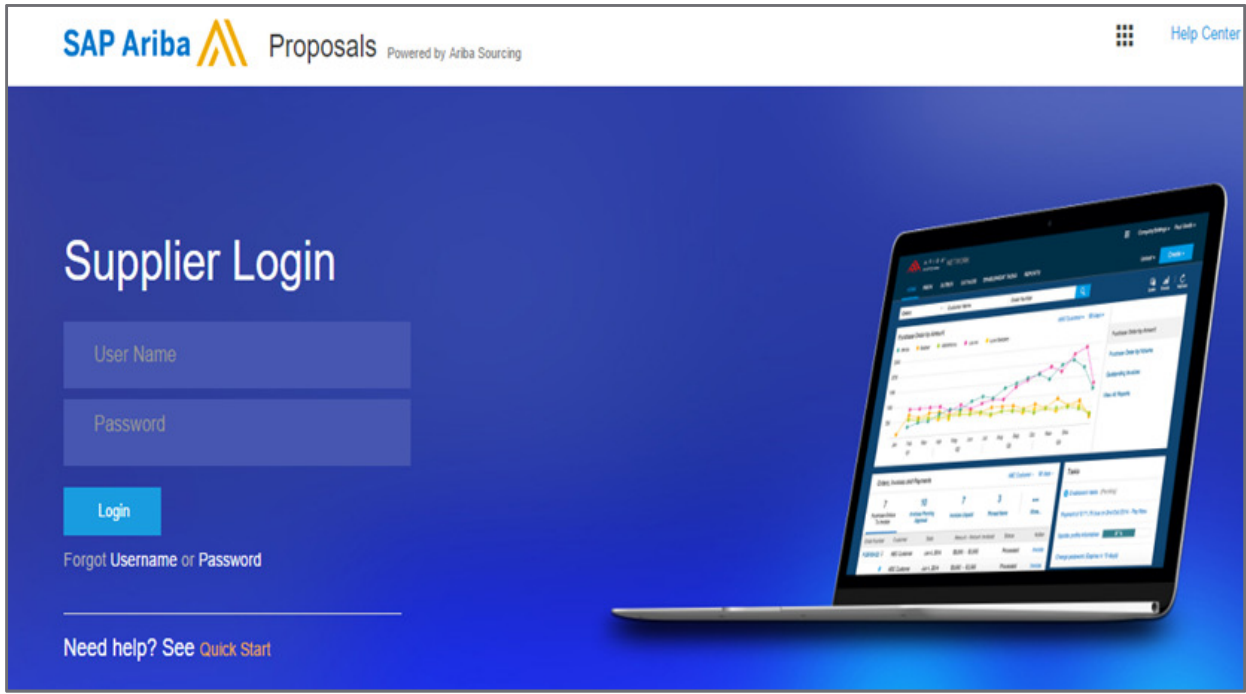

Step 3 - Go to ARIBA APPS  and click on Proposals.

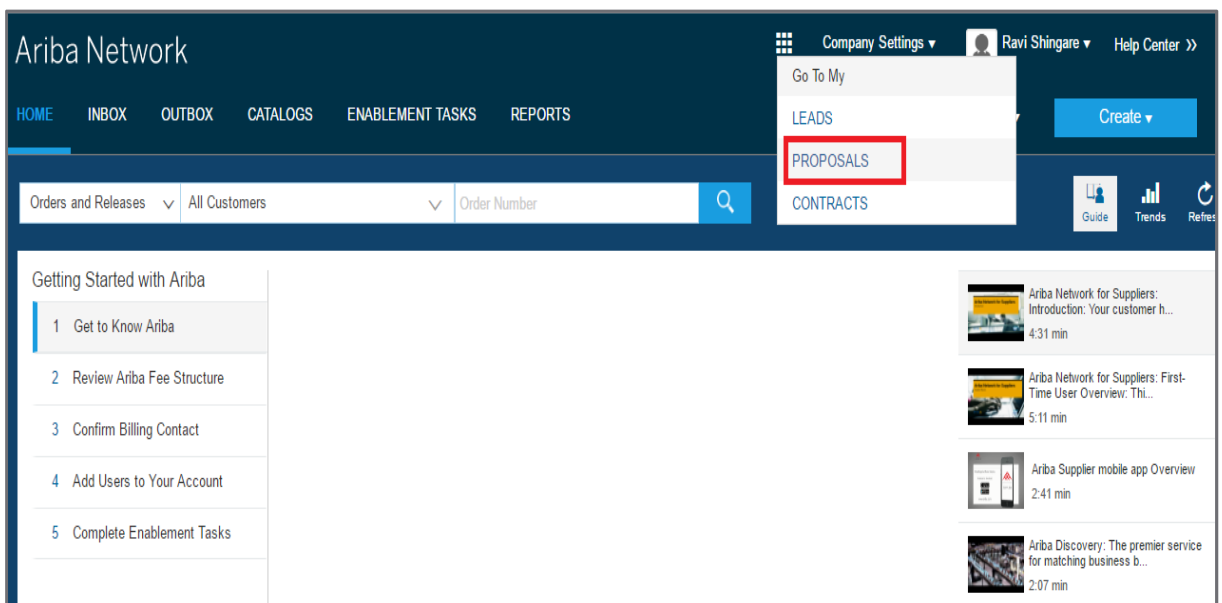

3 Submitting Your Answers / Proposal

3.1.1 Review and Approve "Prerequisites"

Step 1: Review and download all documents & then Click on "Review Prerequisites"

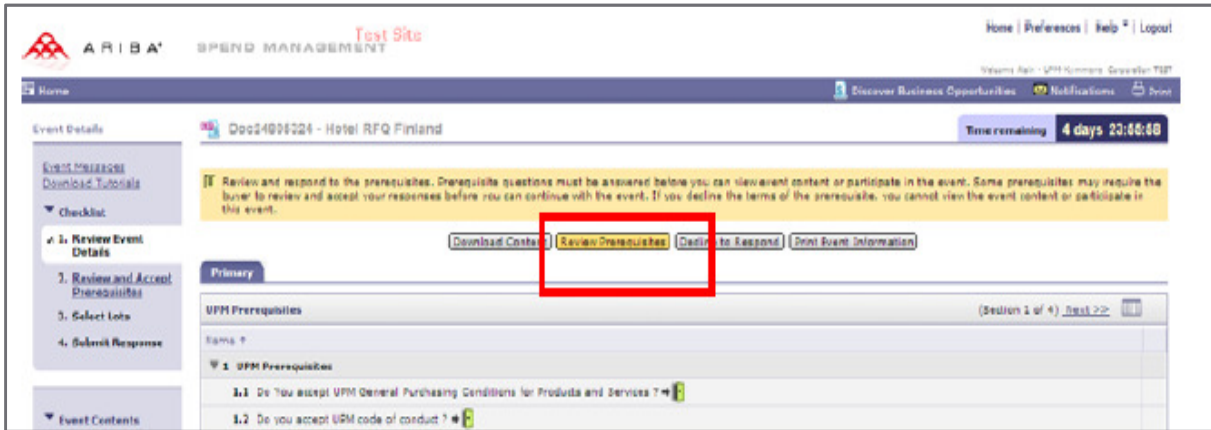

Step 2: Review and accept "Bidder Agreement".

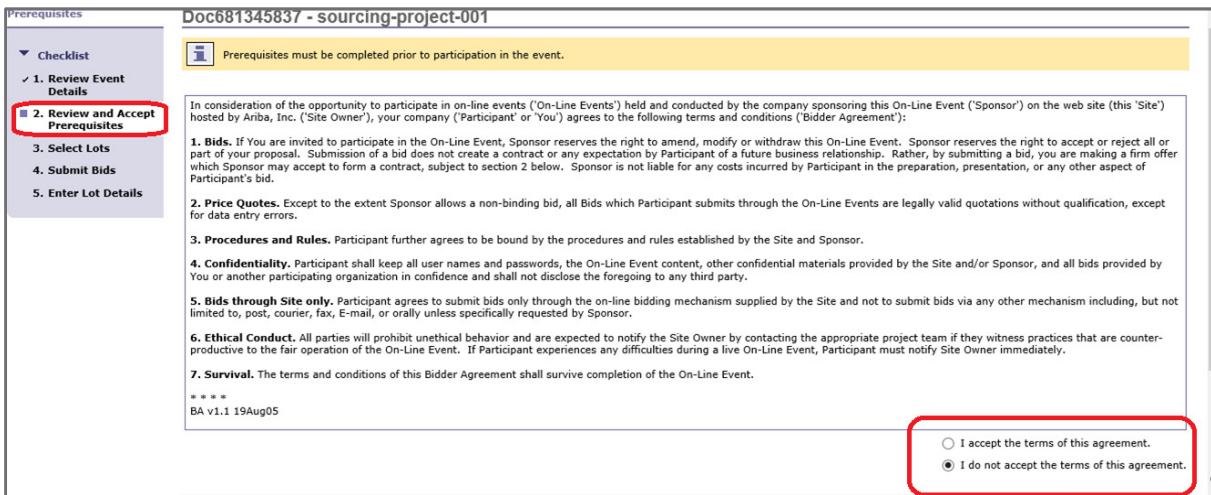

3.1.2 Select Items or Lots

Step 1: Select Items. - If you do not want to quote for any items/lots then you do not select that lot / items and then go ahead for select and submit lot.

Step 2: Click "Submit Select Lots".

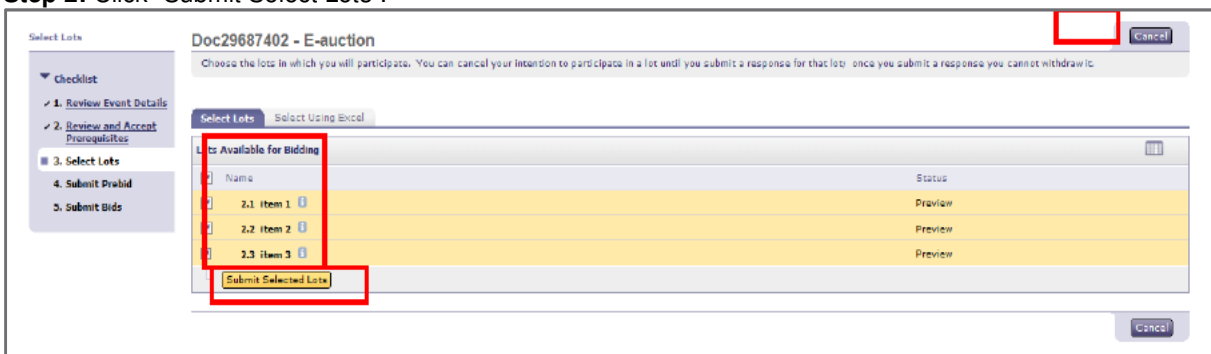

3.1.3 Entering your offer for RFQ

Step 1: as per following screen Vendor Dashboard will appear where RFQ from TATA Power will be visible.

The Tata Power Company Limited-TEST Requested Profile

Welcome to the Ariba Spend Management site. This site assists in identifying world class suppliers who are market leaders in Ariba, Inc. administers this site in an effort to ensure market integrity.

Events

Title	ID	End Time ↓
▶ Status: Completed (104)		
▼ Status: Open (1)		
RFQ-Test 11th Aug 2016	Doc905524000	12/16/2016 6:36 PM
▶ Status: Pending Selection (80)		

Tasks

Name	Status	Due Date	Completion Date
No Items			

Public Profile Completeness

35%

Enter a short description to reach 45% >

There are no matched postings.

Vendor has to complete the vendor registration FORM

Step 2 - Follow all the steps of 3.1.1 to 3.1.3

Step 3 - Vendor has to submit their techno commercial offer in 2.1. In this field Do No attach any price content. For Price Bid put all the unit price and taxes and duties in provided field. Put "0" (ZERO) in not applicable field.

2. Review and Accept Prerequisites

3. Select Lots

4. Submit Response

▼ Event Contents

- 1.4.1 Contract Safety Manual [Annexure I \(Contract Safety M](#)
- 1.4.2 TATA Code of Conduct [Annexure III \(TCOC\).pdf](#)
- ▼ 1.5 Technical Specification
 - 1.5.1 Technical Specification Details [Attach a file](#)
 - ▼ 2 Techno Commercial bid
 - 2.1 Please attach the Techno-Commercial Bid [Attach a file](#)
 - ▼ 3 Price Bid

▼ 3 Price Bid

3.1 Bidder to specify the prices either in terms of percentage (%) or Value where the options are available for both. In case price is specified in percentage (%) , please Specify Zero (0) in the amount field and vice-versa.

3.2 Bearingfor motor 1.90991	More... +	* 15,000.00	INR	30 each
3.3 AMC 20,000 IS-U/CCS CONTRACTS	More... +	* 35,000.00	INR	35 month
3.4 ANALYSIS TAILRACE WTR SAMPLE	More... +	* 35,000.00	INR	45 each

Step 4 - After successfully putting Techno commercial offer and price part then click on "Submit Entire Response"

Requested Delivery Date: Sat, 24 Sep, 2016

(*) indicates a required field

Submit Entire Response | Update Totals | Save | Compose Message

3.1.4 Entering Your Prebid for e-auction

Before participation to the e-auction you must place a pre-bid. If you haven't placed a Prebid in the Prebid time you won't be able to participate to the auction itself.

Step 1: Populate Your Answers.

Step 2: Click "Submit Entire Response".

The screenshot shows the 'Doc681345837 - sourcing-project-001' dashboard. A yellow banner at the top right indicates 'Time remaining in preview 1 day 04:05:05'. A message states: 'The event owner has requested that you submit a prebid before the end of the preview period. You have not yet submitted a prebid.' The left sidebar contains a checklist with '4. Submit Bids' highlighted. The main content area shows a table with columns 'Name' and 'Extended Price'. The table includes sections for '1 Introduction', '2 Commercial Terms' (with a sub-item '2.1 lot-1' for '4 core cable' at '5000 INR'), and '3 Pricing' (with a sub-item '3.1 FOR SITE DELIVERY P&F INCLUSIVE' and a file upload 'COMP-1.xlsx'). At the bottom, the 'Submit Entire Response' button is highlighted in red.

When the Prebid time is still open you can still modify your Prebid:

Click on "revise Prebid" and repeat in step 1 and step 2.

The screenshot shows the same dashboard after a prebid has been submitted. A green banner at the top right indicates 'Time remaining in preview 1 day 04:02:39'. A message states: 'Your prebid has been submitted. You will be notified when the event is open for bidding.' The left sidebar checklist now has '4. Submit Bids' highlighted. The main content area table is updated to show '5,000.00 INR' for the '2.1 lot-1' item. A 'Revise Prebid' button is highlighted in red at the bottom of the table.

3.1.5 Participate to the e-auction

If you have placed a bid in the Prebid time you will be able to participate to the e-action. E-auctions are rather sort in time (usually less than 20 min per item). Once the time is closed you won't be able to bid anymore.

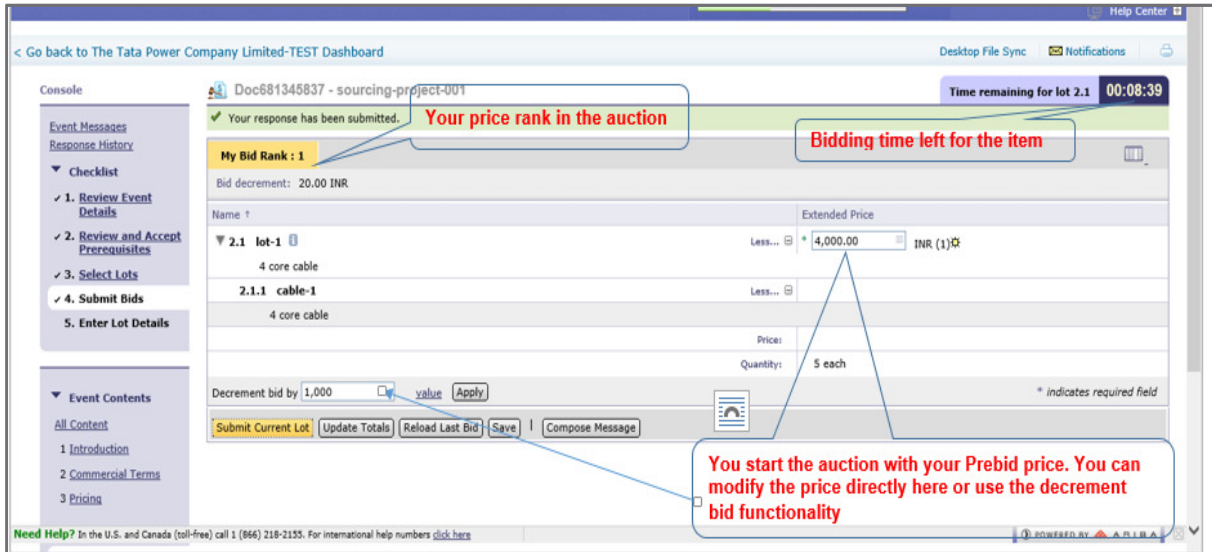

When you want to submit your price presses "submit current lot"

In case the new price you submit is lower by 10% of the starting price (Prebid Price) the following warning Message will be displayed.

To submit the new price, check the box and press submit. If you made a mistake press cancel so that you Mistake would not be submitted.

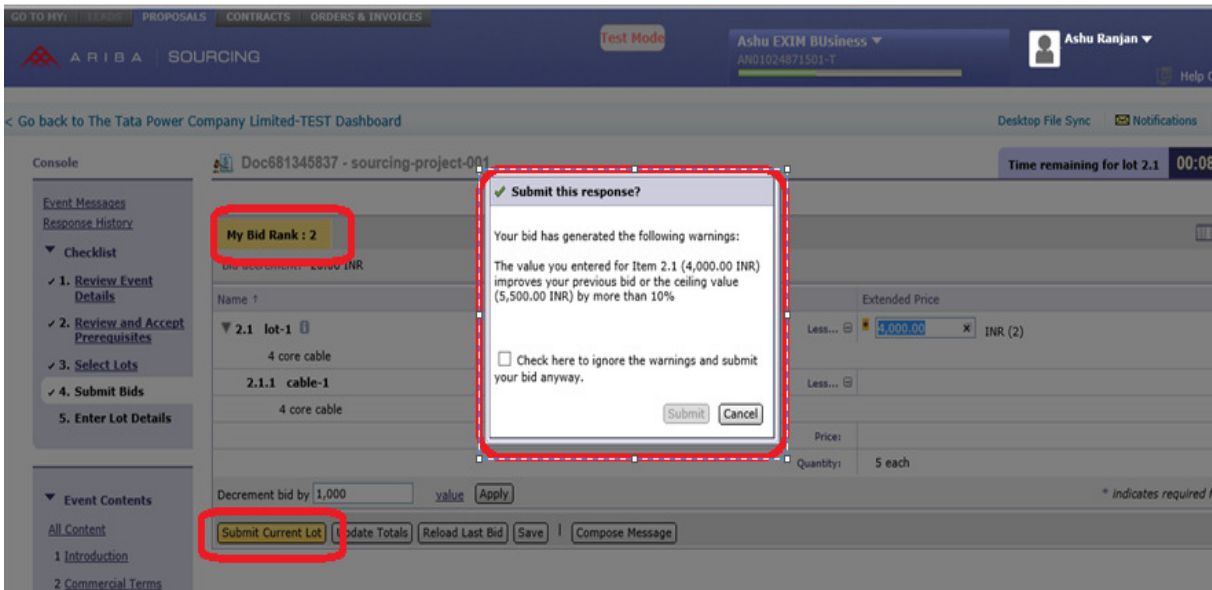

3.1.5.2 What to do if you have a problem during the e-auction?

If you have any problem related the system: - **Call first Tata Power e- Bidding / Auction Cell**

➤ **e- Bidding /Auction Cell details:-**

Core team		
Contact Person	E-Mail Id	Contact Details
Ravi Shingare	ravi.shingare@tatapower.com	9029004168
Himanshu Ranjan	himanshur@tatapower.com	9820339961
Escalation Matrix		
Paresh Bhatt	pareshbhatt@tatapower.com	
C T Prakash	ctprakash@tatapower.com	9223545185

4 Communicating with Tata Power Buyer & Auction team during auction / e- bidding

Step 1: Click “Compose Message”.

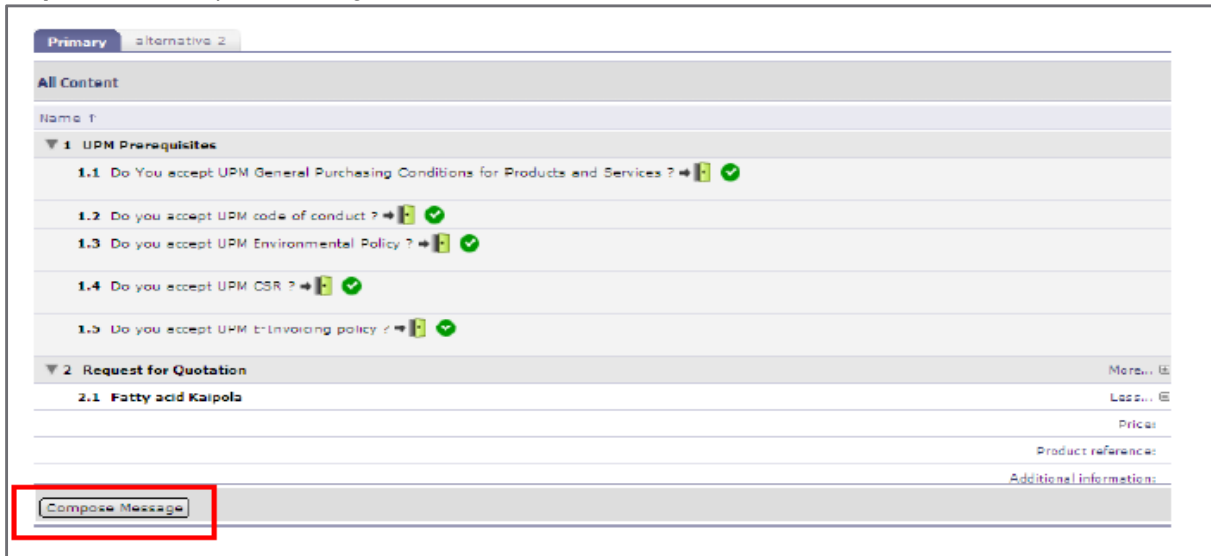

Step 2: Compose Your Message and click “Send”.

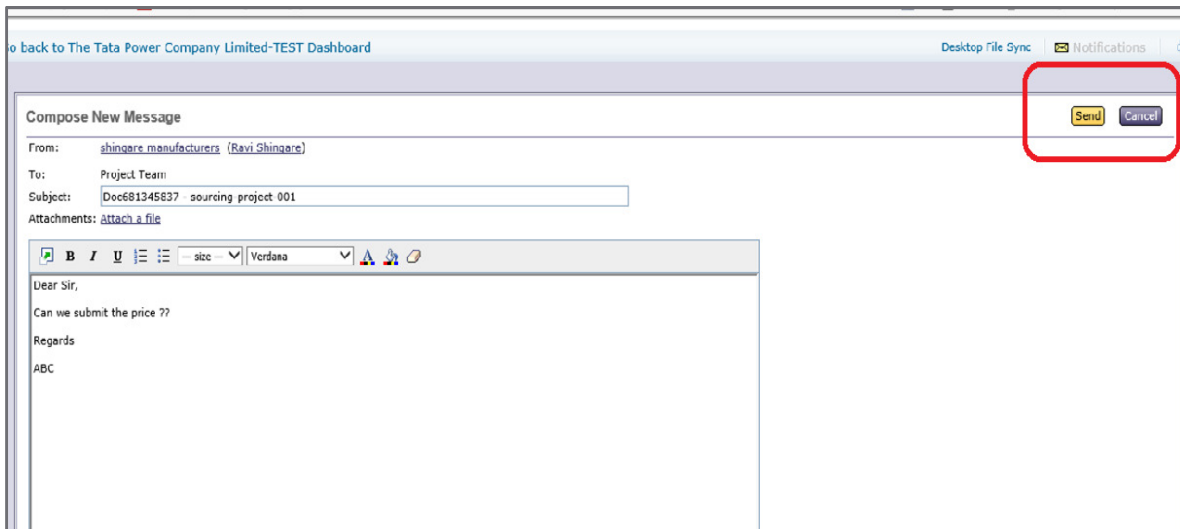

SUPPLIER FREQUENTLY ASKED QUESTIONS

If I registered on my buyer's Ariba Sourcing site in the past, do I need to register again?

Answer- Yes. Although you have registered on your buyer's Ariba Sourcing site in the past, registering on the Ariba Commerce Cloud is required. The registration process only takes a few moments, with a simple one-page registration. Registering on the Ariba Commerce Cloud gives you access to all your buyer relationships with one username and password.

What is the Ariba Commerce Cloud?

Answer: - The Ariba Commerce Cloud is your entry point to all of your seller solutions. Rather than managing log in information for multiple buyers' sites, you will have one log in and one account. This means fewer passwords to remember, easier user maintenance for your company, and a unified profile for your organization.

Do I need to add Product and Service Categories during registration?

Answer:-Yes; this is a required field. Product and Service Categories classify what your company sells, and the system uses this information to match potential business opportunities with your products and services.

Click **Add Product and Service Categories** to select one or more categories from the list of options. During registration, you only need to choose one category, preferably related to the event you are joining. You can add, refine, or remove categories any time after the registration process.

Do I need to add ship-to or service locations during registration?

Answer: - Yes; this is a required field. Ship-to or Service locations inform buyers where your company sells its products or provides its services, and the system uses this information to match potential business opportunities with your products and services.

Click **Add Ship-to or Service Locations** to select one or more sales territories from a list. You can add, refine, or remove ship-to or service locations any time after the registration process.

Do I need to enter a D-U-N-S number when I register?

Answer: - No; this is an optional field. You are only required to complete the fields marked with an asterisk (*). If you enter a D-U-N-S number, and you get a message that the value is already in use, leave the field blank, as D-U-N-S numbers must be unique within the Ariba Commerce Cloud. Your company can have multiple Ariba accounts, but only one account can use the D-U-N-S number.

Additional Information: - D-U-N-S is a registered trademark of Dun & Bradstreet or its subsidiaries in the United States and other countries.

Do I need to enter a Tax ID when I register?

Answer: - No, the Tax ID is an optional field. You are only required to fill in the fields marked with an asterisk (*).

What is the difference between the Email and Username fields in my profile?

Answer: - The Email field represents the email address where you wish to receive email notifications. The Username field is the identifier that you use to access your account. The Username field must be in email format, but you do not have to use a valid email address.

Note: Leave the **This is my username** box checked if you want your email address to be the same as your username.

How do I participate in my buyer's event using an email invitation?

Answer: - Use the **Click here** link in the email notification to access the sourcing event.

While buyers might customize the email content you receive, all email invitations contain a link to access the event.

Depending on your previous experience with Ariba solutions, do one of the following to access the event after you click the link:

- If you are new user, click **Continue** on the welcome page. You continue to register an Ariba account to link with your buyer and participate in the event.
- If you have used Ariba before and have already accessed an event for the buyer-specific account with your current log in ID, click the **Login** button to continue. Log in with your Ariba username and password in order to participate in the event.
- If you already have an existing Ariba Network, Ariba Discovery, or Ariba Sourcing supplier account, but you have not accessed any events for the inviting buyer's site, use the **Click here if you already have an Ariba Commerce Cloud, Ariba Discovery or Ariba Network account** link. After clicking the link, log in with your existing account to move your information to your buyer's site.

Additional Information :- Registering an Ariba account provides you with a consolidated view of all your customer relationships. With this one profile, you can view business opportunities, participate in sourcing events, participate in contract negotiations, and manage orders, catalogs, and invoices.

Why doesn't the link in the email invitation to participate in a sourcing event work?

Answer:-If you cannot click the link, or the link does not open the log in page, highlight and copy the Uniform Resource Locator (URL), and then paste the URL into your web browser.

Can my company have multiple accounts?

Answer:-Your Company can have multiple Ariba accounts, depending on your business needs. For example, if your company has several locations around the world, you might want a separate account for each region.

Most companies choose to have one account with multiple customer relationships, which provides a centralized location to maintain their company profile information and all of their customer relationships.

Additional Information

Consider the following items when deciding whether to have more than one account:

- **Administrators:** For each account, you can have only one account administrator, but the account administrator can provide access to multiple users. All users from your company have their own **Username** and **Password** to access the account.
- **DUNS** (data universal numbering system) **numbers:** You can add your company's DUNS number to only one account. If you plan to have multiple accounts, leave the DUNS number blank during registration.

How do I complete registration if my username already exists?

Answer: - This message means that you already have an Ariba Network, Ariba Discovery, or Ariba Sourcing supplier account registered under username you entered. You can either register a new account by creating a new username, or access one of the following sites to request a password reset for the registered username:

- [Ariba Network](#) (This login page is used for all Ariba Network, Ariba Sourcing, or Ariba Contracts suppliers).
- [Ariba Discovery login page](#)

To reset your password, click the **Having trouble logging in?** Link on the Login page.

Nothing happens when I click Forgot Username and enter my email address

Issue: - Nothing happens when I click the **Forgot Username** link and enter my email address.

Cause: - After you submit your request to retrieve your username, the Ariba Network sends an email notification with usernames that match the email address you submitted.

Some possible reasons why you may not receive this username retrieval email notification:

- The email address on your account does not match the email address you entered when submitting the request.
- Your buyer-specific account was deactivated before you could move it to the Ariba Commerce Cloud. Generally, that means you probably have not participated in an event with that buyer for a while.

Solution: -

- To ensure you receive this email notification:
- Make sure you type the email address configured within your account.

If your buyer-specific account has been deactivated, contact your buyer to determine how to proceed.

Where is my password reset email?

Answer: - After you submit your request for a password reset, Ariba sends instructions to the email address associated with your account. If you didn't receive a password reset email, check the following scenarios to troubleshoot.

The username you entered is in the wrong format, or it isn't associated with the email address you are checking.

- Keep in mind, your username is in the format of a full email address, but it can be associated with any email address you entered previously.
 - Your username is also case-sensitive.
 - To confirm that you are using the correct username and format, return to the Ariba login page, and click the **Having trouble logging in?** link (**Forgot Username** if you're working in Ariba Discovery).
 - Choose **I forgot my username**, and click **Continue**.
 - Enter the email address associated with your account, and click **Submit**.
 - You will receive an email that lists the exact format of the username associated with the email you entered.
-

You entered the correct username, but you still didn't receive the password reset email notification.

- This can occur if the configured email address is different from the account you are checking.
- You might have multiple accounts for your company, so make sure you are attempting to access the correct account.

Your email configuration or company's security settings might also prevent you from receiving the password reset email. To find out, check your junk mail folder or email filter settings to verify that automated emails from Ariba are not blocked from your email account.

 **Why do I get this message on the SAP Ariba Login page: "The username and password pair you entered was not found"?**

Answer: - You entered an incorrect **Username** or **Password**. You might receive this message if you entered a previous **Username** or **Password**. Remember that your **Username** has the format of an email address, and both the **Username** and **Password** are case sensitive.

Click the **Having trouble logging in?** Link on the Login page if you don't remember your log in information.

-: Steps for tender submission:-

Step 1: Vendor will get an **invitation email** from Ariba System. Keep this email, it contains your login Information and a direct link to Ariba.

URL for Supplier Users: <http://tatapower.supplier.ariba.com>

Step 2: Click **"Click Here" to access this event.**

Step 3: If you are first time vendor you will get the **"Sign UP" window**. Click on the same. If this screen is not appearing then close the window and follow the steps.

If the vendor has already created User id and password then after step 2 he will directly get the login screen. After credentials → click on ARIBA APPS and click on Proposals.

Step 4: After Continue simple one-page registration screen will open. Define your password and secret question. Click "OK"

Step 5: You will be able to see the RFQ

Step 6: After review and downloading of all documents click on **"Review Prerequisites"**

Step 7: Review and accept **"Bidder Agreement"**.

Step 8: Select Items or Lots → **Click "Submit Select Lots"**

Step 9: Vendor has to submit their **techno commercial offer in 2.1." Pls Attach Techno commercial Bid "**In this field Do No attach any price content.

For Price Bid put all the unit price and taxes and duties in provided field. Put "0" (ZERO) in not applicable field.

Step 10: After successfully putting Techno commercial offer and price part then click on **"Submit Entire Response"**